



Apple
Multiple Scan 15^{AV}
Display



User's Guide

15-inch CRT (13.75-inch diagonal viewable image size)

 Apple Computer, Inc.

© 1996 Apple Computer, Inc. All rights reserved.

Under the copyright laws, this manual may not be copied, in whole or in part, without the written consent of Apple. Your rights to the software are governed by the accompanying software license agreement.

The Apple logo is a trademark of Apple Computer, Inc., registered in the U.S. and other countries. Use of the “keyboard” Apple logo (Option-Shift-K) for commercial purposes without the prior written consent of Apple may constitute trademark infringement and unfair competition in violation of federal and state laws.

Every effort has been made to ensure that the information in this manual is accurate. Apple is not responsible for printing or clerical errors.

Apple Computer, Inc.
1 Infinite Loop
Cupertino, CA 95014-2084
(408) 996-1010

Apple, the Apple logo, ColorSync, LaserWriter, Macintosh, Power Macintosh, and QuickTake are trademarks of Apple Computer, Inc., registered in the U.S. and other countries.

AppleCD and Mac are trademarks of Apple Computer, Inc.

Acrobat, Adobe, Adobe Illustrator, Adobe Photoshop, and PostScript are trademarks of Adobe Systems Incorporated or its subsidiaries and may be registered in certain jurisdictions.

The Energy Star logo is a service mark of the U.S. Environmental Protection Agency.

Helvetica and Times are registered trademarks of Linotype-Hell AG and/or its subsidiaries.

NuBus is a trademark of Texas Instruments.

Simultaneously published in the United States and Canada.

Mention of third-party products is for informational purposes only and constitutes neither an endorsement nor a recommendation. Apple assumes no responsibility with regard to the performance or use of these products.



Contents

Communications regulation information v

1 Setting Up 1

Important safety instructions 1

What about electromagnetic emissions? 2

Getting ready to set up 3

Your Multiple Scan 15AV Display at a glance 4

Choosing a good location for your monitor 5

Connecting the monitor's base 6

Positioning the monitor 7

Do you need a video card? 8

Do you need an adapter? 8

Using more than one monitor 8

Connecting the monitor to your computer 9

Connecting headphones to your monitor 11

Turning the monitor on 11

Installing the display software 12

2	Using the Display Software	15	
	About the Control Strip	15	
	Working with the Control Strip	16	
	Changing screen resolution	17	
	Other things you can do with the Monitors control panel	19	
	Conserving energy	20	
	What happens after you turn on the energy-saving feature	21	
	Using Energy Saver with a screen saver	21	
	Using ColorSync	22	
	Configuring the Control Strip	23	
	Showing and hiding the Control Strip	23	
	Setting a keyboard command to show and hide the Control Strip	24	
	Changing the font in Control Strip menus	25	
3	Adjusting the Picture	27	
	Accessing the monitor's controls	27	
	Making adjustments to the picture	28	
	Adjusting the brightness of the picture	28	
	Adjusting the contrast of the picture	28	
	Adjusting the center of the picture	28	
	Adjusting the size of the picture	29	
	Adjusting the sound volume	30	
	Resetting controls to the factory settings	30	
4	Tips and Troubleshooting	31	
	Care and cleaning	31	
	Protecting your monitor from theft	32	
	Troubleshooting	32	
	Appendix	Technical Information	39

Communications regulation information

FCC statement

This equipment has been tested and found to comply with the limits for a Class B digital device in accordance with the specifications in Part 15 of FCC rules. See instructions if interference to radio or television reception is suspected.

Radio and television interference

The equipment described in this manual generates, uses, and can radiate radio-frequency energy. If it is not installed and used properly—that is, in strict accordance with Apple’s instructions—it may cause interference with radio and television reception.

This equipment has been tested and found to comply with the limits for a Class B digital device in accordance with the specifications in Part 15 of FCC rules. These specifications are designed to provide reasonable protection against such interference in a residential installation. However, there is no guarantee that interference will not occur in a particular installation.

You can determine whether your computer system is causing interference by turning it off. If the interference stops, it was probably caused by the computer or one of the peripheral devices.

If your computer system does cause interference to radio or television reception, try to correct the interference by using one or more of the following measures:

- Turn the television or radio antenna until the interference stops.
- Move the computer to one side or the other of the television or radio.
- Move the computer farther away from the television or radio.
- Plug the computer into an outlet that is on a different circuit from the television or radio. (That is, make certain the computer and the television or radio are on circuits controlled by different circuit breakers or fuses.)

If necessary, consult an Apple-authorized service provider or Apple. See the service and support information that came with your Apple product. Or, consult an experienced radio/television technician for additional suggestions.

IMPORTANT Changes or modifications to this product not authorized by Apple Computer, Inc., could void the FCC Certification and negate your authority to operate the product.

This product was tested for FCC compliance under conditions that included the use of Apple peripheral devices and Apple shielded cables and connectors between system components. It is important that you use Apple peripheral devices and shielded cables and connectors between system components to reduce the possibility of causing interference to radios, television sets, and other electronic devices. You can obtain Apple peripheral devices and the proper shielded cables and connectors through an Apple-authorized dealer. For non-Apple peripheral devices, contact the manufacturer or dealer for assistance.

DOC statement

DOC Class B Compliance This digital apparatus does not exceed the Class B limits for radio noise emissions from digital apparatus as set out in the interference-causing equipment standard entitled “Digital Apparatus,” ICES-003 of the Department of Communications.

Observation des normes—Classe B Cet appareil numérique respecte les limites de bruits radioélectriques applicables aux appareils numériques de Classe B prescrites dans la norme sur le matériel brouilleur : “Appareils Numériques”, NMB-003 édictée par le ministre des Communications.

VCCI statement

情報処理装置等電波障害自主規制について

この装置は、第二種情報装置（住宅地域又はその隣接した地域において使用されるべき情報装置）で住宅地域での電波障害防止を目的とした情報処理装置等電波障害自主規制協議会（VCCI）基準に適合しております。

しかし、本装置をラジオ、テレビジョン受信機に近接してご使用になると、受信障害の原因となることがあります。

取扱説明書に従って正しい取り扱いをしてください。

1

Setting Up



The Apple Multiple Scan 15AV Display is a 15-inch color monitor (diagonal viewable image size is 13.75 inches) that supports a variety of resolutions and has a built-in amplifier and stereo speakers for producing sounds and music. This chapter describes important safety information, setting up and connecting the monitor to your computer, and installing the monitor software on your computer.

Important safety instructions

For your own safety and that of your equipment, always take the following precautions.

Disconnect the power plug (by pulling the plug, not the cord) if any of the following conditions exists:

- the power cord or plug becomes frayed or otherwise damaged
- you spill something into the case
- your monitor is exposed to rain or any other excess moisture
- your monitor has been dropped or the case has been otherwise damaged
- you suspect that your monitor needs service or repair
- you want to clean the case (use only the recommended procedure described in “Care and Cleaning” in Chapter 4)

IMPORTANT The only way to disconnect power completely is to unplug the power cord. Make sure at least one end of the power cord is within easy reach so that you can unplug the monitor when you need to.

Be sure that you always do the following:

- Keep your monitor away from sources of liquids, such as wash basins, bathtubs, shower stalls, and so on.
- Don't remove the cover of the monitor.
- Don't set anything on top of the monitor (such as a book or cup).
- Keep the monitor's vents free from obstruction.
- Protect your monitor from dampness or wet weather, such as rain, snow, and so on.
- Read all the installation instructions carefully before you plug your monitor into a power source.
- Keep these instructions handy for reference by you and others.
- Follow all instructions and warnings dealing with your system.

WARNING Electrical equipment may be hazardous if misused. Operation of this product, or similar products, must always be supervised by an adult. Do not allow children access to the interior of any electrical product and do not permit them to handle any cables.

What about electromagnetic emissions?

There has been recent public discussion of the possible health effects of prolonged exposure to extremely low frequency (ELF) and very low frequency (VLF) electromagnetic fields. Such fields are associated with electromagnetic sources such as television sets, electrical wiring, and some household appliances—as well as computer monitors.

Apple has reviewed scientific reports and sought the counsel of government regulatory agencies and respected health organizations. Based on the prevailing evidence and opinions, Apple believes that the electric and magnetic fields produced by computer monitors do not pose a health risk.

In response to those customers who wish to reduce their exposure to electromagnetic fields, Apple has lowered the emission levels of our products. We are also actively encouraging further scientific research so we can continue to promote the health and safety of our customers and employees.

Getting ready to set up

As you begin to set up your display system, be sure you have easy access to the following items for your Multiple Scan 15AV Display:

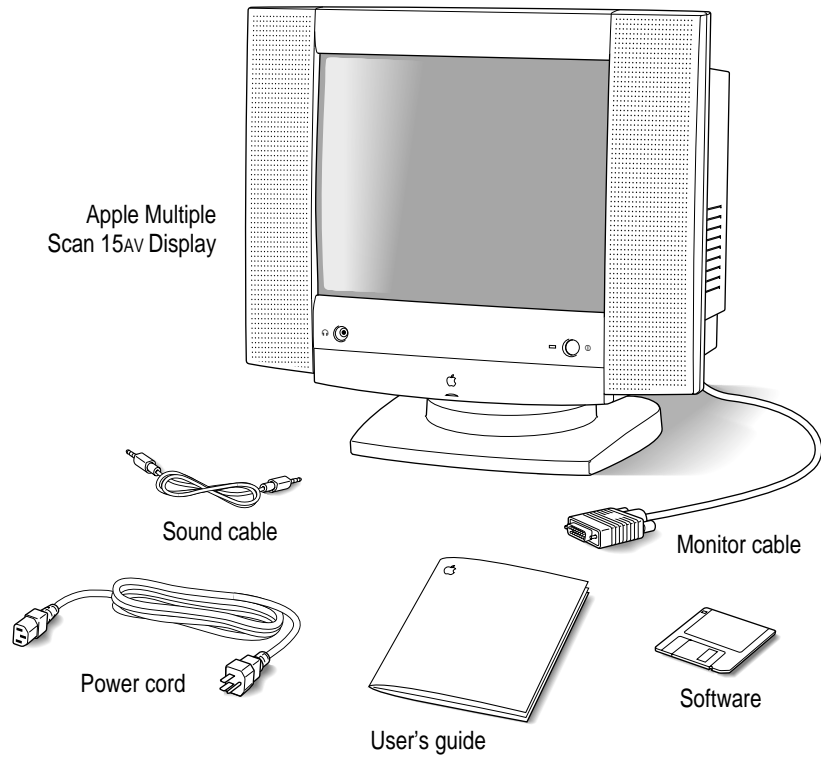

Note: Your power cord may appear different from the one pictured here.

Your Multiple Scan 15Av Display at a glance

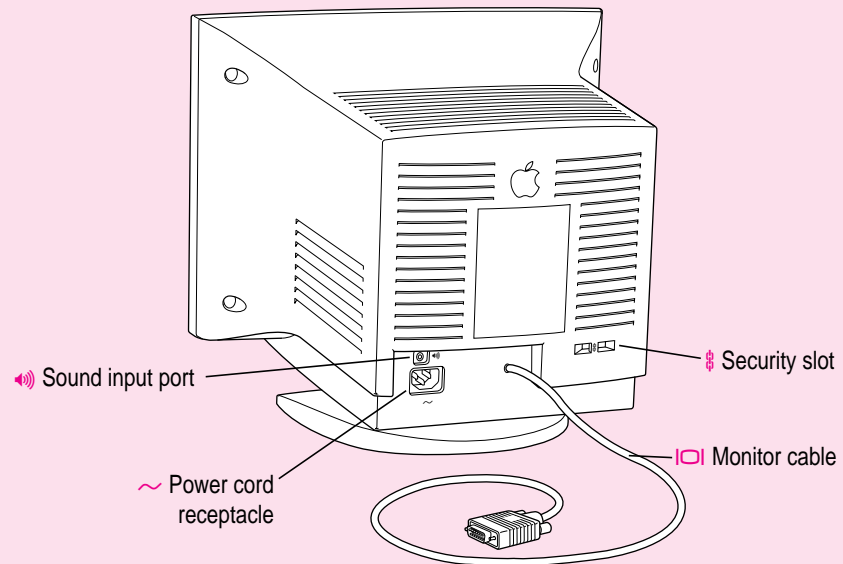
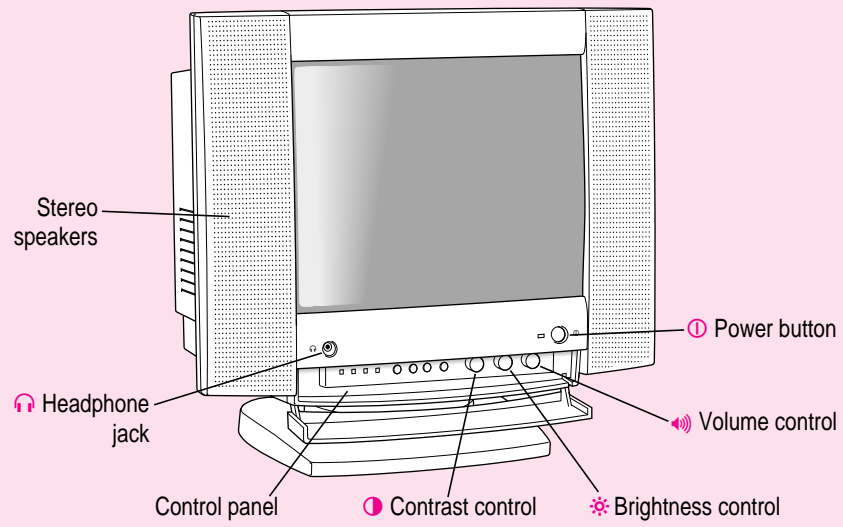

Choosing a good location for your monitor

Here are some key factors to consider when determining where to place your monitor:

- Be sure that the desk or table can support the monitor's weight—approximately 30 pounds.
- Make sure that the power cord will reach an available AC outlet.
- Make sure the monitor cable will reach from the back of the monitor to your computer. The monitor cable should be unobstructed when you swivel and tilt the monitor, so allow at least 6 inches of clearance in the back. If you don't allow enough clearance, the monitor connector might be damaged when the cable hits an obstruction.

Connecting the monitor's base

The monitor and base are packaged separately. To connect the monitor's base, follow these steps:

- 1 Place the monitor on its left side on a table or other firm surface.
- 2 Place the base on its side facing the bottom of the monitor.
- 3 Hook the rear latches into the holes at the rear of the monitor.
- 4 Insert the front latches into the slots at the front of the monitor.

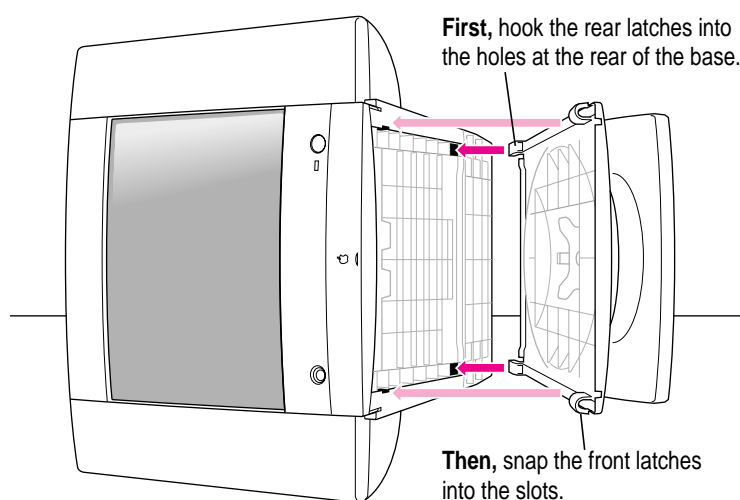

- 5 Turn the monitor upright.

You're finished connecting the base.

Positioning the monitor

Once your monitor is in place, either on top of your computer or next to it on a desk or table, follow these steps:

- 1 Place the monitor so that the screen faces the user.**
- 2 To slide the monitor, lift the front up slightly and push or pull in the direction you want.**
- 3 Adjust the viewing angle of the monitor by tilting it up or down and turning it left or right on its stand.**

Position the monitor so that when you use it, no bright light is behind the monitor or reflected on the screen. Your eyes should be about level with the top edge of the screen and between 18 and 28 inches (45 to 70 cm) away. Take occasional breaks when using your computer, to focus your eyes on a distant object.

For your greatest comfort, use the following illustration to help you in positioning your monitor.

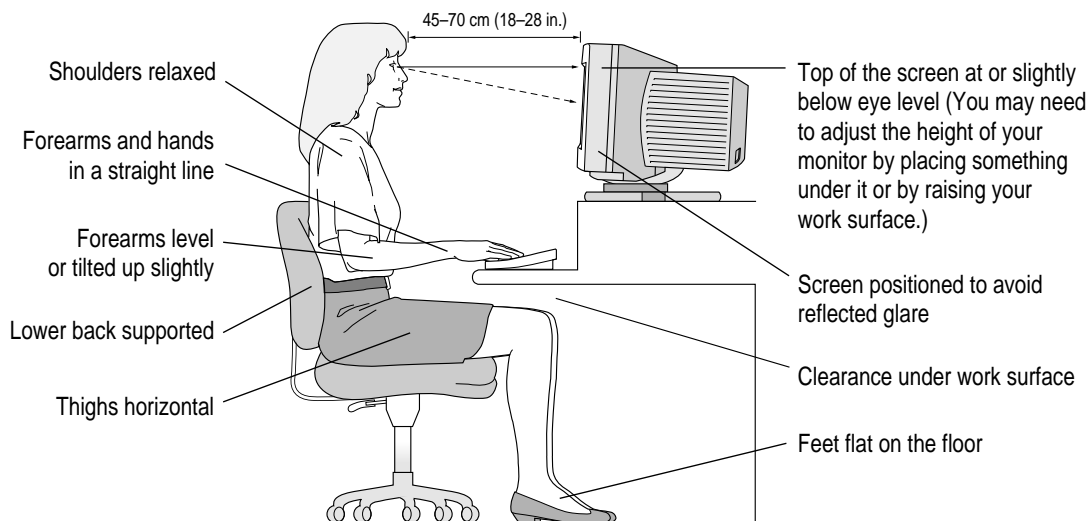

Do you need a video card?

To use the Multiple Scan 15AV Display, you need compatible video circuitry built into your computer or a compatible video card installed in your computer. If you are unsure whether your computer has the appropriate built-in video capability, check the technical specifications that came with your computer or check with an Apple-authorized dealer or service provider.

If your computer does not have built-in video capability, you need to install a video card (available from an Apple-authorized dealer or service provider). Depending on your computer model, you will need either a NuBus™ card or a PCI card. You should install the video card before you connect the monitor to your computer. For instructions on installing a card inside your computer, see the manual that came with your computer or video card.

Do you need an adapter?

Some Macintosh computer models and some video cards from manufacturers other than Apple require an adapter to connect the monitor to the computer. Adapters are available from an Apple-authorized dealer or service provider.

Using more than one monitor

If your computer has NuBus or PCI expansion slots, you can connect additional monitors to your computer. You may need to install a video card for each additional monitor you are using. See the documentation that came with your computer for information on working with additional monitors.

Connecting the monitor to your computer

Follow these steps to connect the Multiple Scan 15AV Display to your computer:

IMPORTANT Before you connect any cords or cables, make sure that your computer is turned off and unplugged.

WARNING Your monitor is equipped with a three-wire grounding plug—a plug that has a third (grounding) pin. This plug will fit only a grounded AC outlet. This is a safety feature. If you are unable to insert the plug into the outlet, contact a licensed electrician to replace the outlet with a properly grounded outlet. Do not defeat the purpose of the grounding plug!

- 1 Connect the socket end of the power cord to the power cord receptacle on the back of the monitor.

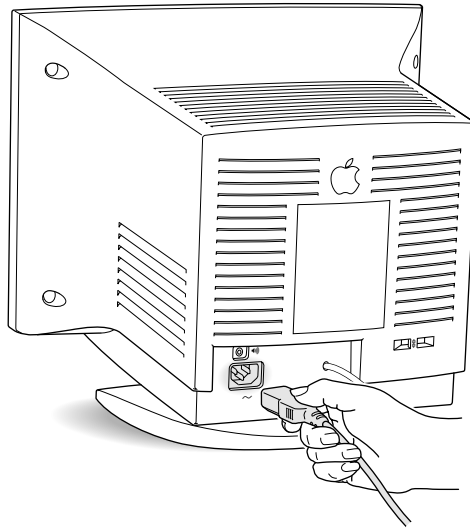



- 2 Plug the other end of the power cord into an outlet or power strip.**

If your computer has an available power socket, you can use a detachable power cord with a recessed end to plug the monitor directly into the computer. You can get this cord from an Apple-authorized dealer or service provider.

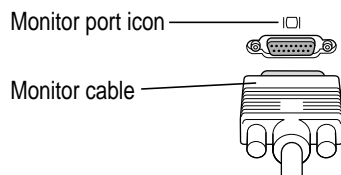
- 3 Connect the monitor cable to the monitor port (marked with ) on the back of the computer.**





If you installed a video card in your computer, connect the monitor cable to the video card's port. For more information about installing video cards, see the manual that came with your computer or video card.

- 4 Tighten the thumbscrews on the connection.**
- 5 Attach one end of the included sound cable to the sound output port (marked by ) on the back of the computer.**
- 6 Attach the other end of the sound cable to the sound input port (marked by ) on the back of the monitor.**

Connecting headphones to your monitor

If you wish, you can plug a pair of headphones (or other sound output device) into the Multiple Scan 15AV Display. To plug your headphones into the monitor, follow these steps:

- 1** If your headphones are attached to the sound output port (marked by ) on the back of your computer, unplug them.
- 2** If the sound cable that came with the Multiple Scan 15AV Display is not connected, connect it to the sound output port on the computer and on the monitor. (Both sound output ports are marked by )
- 3** Plug the headphones into the headphone port (marked by ) on the front of the monitor.

When headphones are plugged in, you do not hear sound through the stereo speakers. Sound and music play through the headphones only.

Turning the monitor on

To turn on the monitor for the first time:

- 1** Start up your computer.
- 2** Press the Power button on the front right side of the monitor.

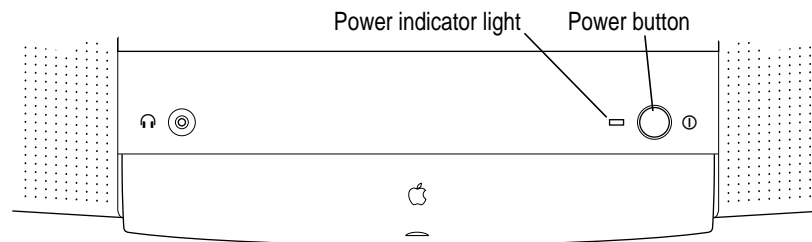

The green power indicator light goes on.

If the green light does not go on, press the power switch again. If this doesn't work, make sure you've connected the monitor to your computer properly (see "Connecting the Monitor to Your Computer," earlier in this chapter) and make sure the monitor is plugged into a working electrical outlet. Also, make sure your computer is turned on.

Note: If the power light is yellow or amber, one of the following may be the cause:

- The computer isn't turned on.
- The monitor's cable isn't connected properly to the computer.
- The video circuitry or video card in your computer is not compatible with the monitor. Your Macintosh may need a video card or adapter to use the monitor. See "Do You Need a Video Card?" earlier in this chapter.
- The computer and monitor are in sleep to conserve energy. See "Conserving Energy" in Chapter 2.

To make full use of the features available to you with this monitor, you should install the display software. Follow the instructions in "Installing the Display Software," next.

Installing the display software

To install the display software for the Multiple Scan 15AV Display, follow these steps:

- 1 Insert the *Apple Multiple Scan Software for Macintosh* disk into a floppy disk drive.

The disk's icon appears on the desktop.

- 2 Double-click the disk icon to open it.



- 3 Double-click the Installer icon to start the Installer program.



After a moment, the Installer opens and you see the Welcome screen.

- 4 Read the Welcome screen and click OK.

The Installer screen appears.

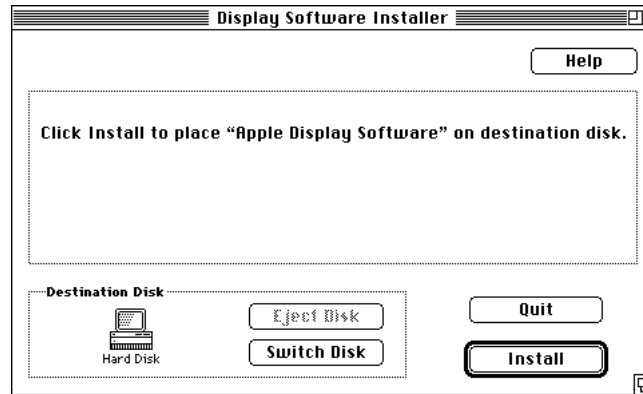

- 5 Make sure the disk named in the box is the one on which you want to install the software. If not, click Switch Disk until the correct disk name appears.
- 6 Click the Install button.

The Installer takes a few moments to calculate what needs to be done and then begins to copy files.

- 7 When the installation is complete, follow the instructions on the screen.

After the installation, the Installer tells you to restart your computer (if you installed the software onto your startup disk) or to quit (if you installed the software onto another disk).

The software is now installed and the monitor is ready for use.

Note: To change the screen resolution, see “Changing Screen Resolution” in Chapter 2.

2

Using the Display Software



This chapter explains how to use the new display software you have installed. Your software includes a new feature called the Control Strip, which you can use to change monitor settings quickly and easily. You can use the Control Strip to change screen resolutions, change the number of colors your monitor displays, and change the volume of your computer's beep sound. Your monitor also comes with control panels that you can use to save energy and fine-tune your monitor's use of color.

About the Control Strip

When you start up your Macintosh after installing your new display software, you will notice the Control Strip at the lower-left edge of your screen. The Control Strip is a new way of changing certain settings from your desktop without opening control panels.

Note: Some versions of the Macintosh Operating System will show different modules in the Control Strip. If your Control Strip doesn't match what's shown in this chapter, consult the on-screen help that came with your computer or system software upgrade kit.



Monitor Resolution Sound Volume Monitor BitDepth

You can change the following settings with the Control Strip modules:

- Monitor Resolution lets you change the resolution of the screen.
- Monitor BitDepth lets you change the number of colors on your screen.
- Sound Volume lets you change the volume of the system sound.

To use a module, press it and choose a setting from the pop-up menu that appears.

Note: If you use more than one monitor, the monitors are identified by number in the Control Strip menus. To see which number goes with which monitor, experiment with the modules, or open the Monitors control panel (in the Control Panels folder, available from the Apple [] menu) and press the Identify button. The number of each monitor appears on its screen. (On some models, the control panel has a different name.)

Working with the Control Strip

You can move, collapse, and expand the Control Strip, and you can change the order of the controls.



- To move the Control Strip, hold down the Option key on your keyboard and drag the tab at the right end of the Control Strip. The Control Strip always stays on the left or right edge of a screen.
- To make the Control Strip shorter or longer, drag the tab to the left or right.
- To see hidden controls when the Control Strip is not expanded to its full size, click the right and left arrows.
- To collapse the Control Strip to its smallest size, click the tab or the box. To expand the collapsed Control Strip to its original size, click the tab.
- To move a control to a new position in the Control Strip, hold down the Option key on the keyboard and drag the control to where you want it.

For more information on setting up the Control Strip, see “Configuring the Control Strip,” later in this chapter.

Changing screen resolution

You can change the resolution of your monitor to zoom in for detail work or to zoom out and see a whole page or more at a time.

- **To change screen resolution with the Control Strip, press the Resolution control and choose the resolution you want in the menu.**



To change your screen resolution with the Monitors control panel, follow these steps.

Note: Some models use a different control panel. If you don't see the Monitors control panel, consult the on-screen help that came with your computer or system software upgrade kit.

- 1 Choose Control Panels from the Apple () menu.**

A window opens showing all the control panels.

- 2 Double-click the Monitors icon to open the Monitors control panel.**



Monitors

Double-click the icon. (If you don't see it, click the scroll bar arrows. If you still can't find it, you may have forgotten to install the software, as described in Chapter 1.)

3 Make the following choices in the control panel:

Note: The choices you see in this window may differ from those shown here, depending on your computer, your video capability, and the monitors attached.

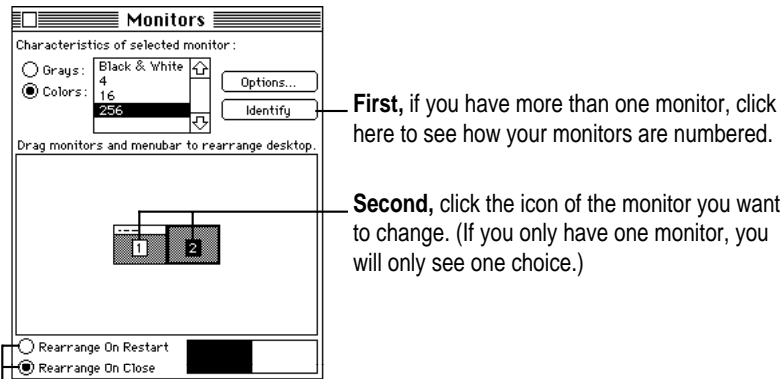

Third, choose when you want the change to take place—after you close this window or when you restart your computer.

4 Click the Options button to see what resolutions you can choose.

5 Click a resolution to select it.

The choices you see in this window depend on your computer, video capability, and the monitors that are attached.

If you don't see any options for changing resolutions, you may have selected the wrong monitor in the control panel, or your computer and video card may not support multiple resolutions. Click Cancel, then try step 3 again.

Note: In some cases, you can see additional choices if you hold down the Option key on the keyboard while you click the Options button. However, these choices may not be optimized for your monitor. If you try to make a choice that is not optimized for your monitor, you'll see a message, or the monitor will go blank or show "static" for several seconds, then will switch back to an optimized resolution.

- 6 **Click OK to return to the main window of the Monitors control panel.**

Depending on which option you selected in the control panel, the new resolution will be displayed when you close the dialog box or when you restart the computer.

- 7 **Close the Monitors control panel by clicking the close box in the upper-left corner.**

IMPORTANT Make sure you close the Monitors control panel before starting any other work.

Note: When you change monitor resolutions, the folders and icons on your desktop may reposition themselves to accommodate the new screen size.

- 8 **If the image is distorted, try another resolution, or adjust the controls on the monitor as explained in Chapter 3.**

Other things you can do with the Monitors control panel

You can also use the Monitors control panel to

- arrange how multiple monitors work together
- choose how many colors or shades of gray each monitor can display (you can also make this change using the Control Strip)

See the instructions that came with your computer for details. (Some models have a different control panel.)

Conserving energy

When you save energy, you save natural resources and reduce pollution. Your Multiple Scan 15AV Display includes features that automatically save energy. You can increase the energy savings by turning your computer and monitor off if you won't be using them for a while—for example, overnight or over the weekend.

You use the Energy Saver control panel to tell the monitor how to conserve energy after a specified period of inactivity.

You can use the control panel if your monitor is connected to a computer that complies with the United States Environmental Protection Agency's Energy Star program. (Look for the EPA Energy Star logo on the box.)

To use the control panel, follow these steps:

- 1 Choose Control Panels from the Apple (🍏) menu.**

A window opens showing all the control panels.

- 2 Double-click the Energy Saver icon to open the Energy Saver control panel.**



Energy Saver

Double-click the icon. (If you don't see it, click the scroll bar arrows. If you still can't find it, you may have forgotten to install the software, as described in Chapter 1.)

- 3 Make the following choices in the control panel:**

Click here to turn Energy Saver on or off. When there's an X in this box, Energy Saver is on.

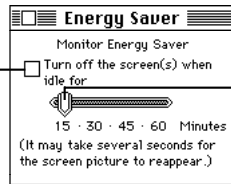

If Energy Saver is on, slide this control to determine how long Energy Saver will wait without activity before darkening the screen.

- 4 Close the control panel.**

What happens after you turn on the energy-saving feature

When Energy Saver is on, the monitor “goes to sleep” after a specified period of inactivity. The monitor screen looks dark and the monitor is using less energy. When the monitor is asleep, your computer is still working. But to prevent accidental changes, you can’t make any changes while the monitor is asleep.

To “wake up” the monitor, move the mouse or press any key on the keyboard. Your computer beeps while the monitor is waking up. The process takes about 20 seconds, and you can begin work as soon as the computer stops beeping. (The beep volume cannot be adjusted; it is not controlled by the computer’s sound software.)

IMPORTANT The Energy Saver control panel works with Apple monitors (such as this one) that comply with the EPA’s Energy Star program and any other monitor that complies with the Video Electronics Standards Association’s Display Power Management Standard (VESA DPMS). Your computer model must also be compatible with Energy Star. Other monitors will darken after the specified inactivity period, but they won’t go to sleep or save energy.

Using Energy Saver with a screen saver

“Screen saver” programs darken the screen or display a changing image on the monitor if the computer is not used for prolonged periods. Both screen saver programs and the Energy Saver feature prevent images from “burning in” and damaging the screen. Energy Saver also conserves energy.

If you wish, you can use both Energy Saver and a screen saver program. Set the screen saver to come on before Energy Saver, so if you’re away from the computer for a short while, you can return to work immediately, without waiting for the monitor to wake up. If you’re gone for a while longer, however, the monitor won’t use as much energy.

Using ColorSync

ColorSync is Apple's unique color-matching software that ensures that Apple color printers print the best possible reproduction of the colors that appear on your monitor screen. ColorSync is also used by Apple color scanners and the QuickTake camera to capture color images and accurately reproduce their colors on the screen. ColorSync maintains consistent colors between color input, your monitor, and color printing devices so that the colors of your original image are accurately reproduced on screen and when printed.

The ColorSync software works automatically in the background. When you install the display software, your computer is automatically set to use ColorSync with your monitor.

If you use more than one color monitor with your Macintosh and want to print a color image from a specific monitor, you can obtain the best color matching by setting ColorSync to use a specific monitor.

To set up ColorSync for a specific monitor:

- 1 Choose Control Panels from the Apple () menu.**
A window opens showing all the control panels.
- 2 Double-click the ColorSync icon to open the ColorSync control panel.**



ColorSync™ System Profile

The ColorSync control panel appears.

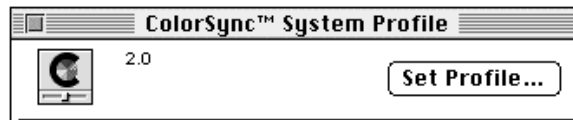

3 Click Set Profile.

A dialog box appears that enables you to select the name of the monitor you want to use.

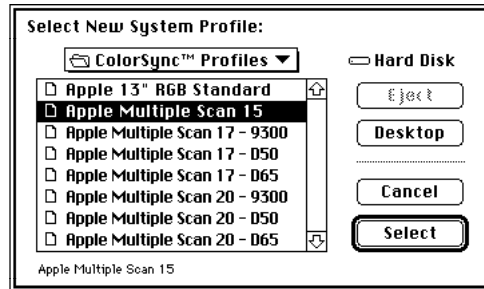

4 Click a monitor name to select it.

5 Click Select to return to the main window of the ColorSync control panel.

6 Close the ColorSync control panel by clicking the close box in the upper-left corner.

Configuring the Control Strip

With the Control Strip control panel, you can show and hide the Control Strip and choose a keyboard command to show/hide the Control Strip. You can also choose the font that appears in the Control Strip menus.

Showing and hiding the Control Strip

To show or hide the Control Strip, follow these steps:

1 Choose Control Panels from the Apple () menu.

2 Double-click the Control Strip icon to open it.



Control Strip

The Control Strip control panel appears.

- 3 To show or hide the Control Strip, click the button labeled Show Control Strip or Hide Control Strip.

The change takes effect immediately.

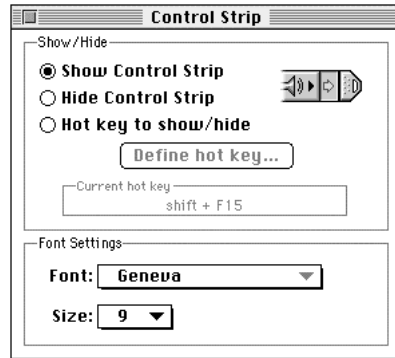

- 4 Click the close box to close the control panel.

Setting a keyboard command to show and hide the Control Strip

To set a keyboard command to show and hide the Control Strip, follow these steps:

- 1 Choose Control Panels from the Apple () menu.
- 2 Double-click the Control Strip icon to open it.



Control Strip

The Control Strip control panel appears.

- 3 To turn on the keyboard command for showing and hiding the Control Strip, click “Hot key to show/hide.”

The keyboard command for showing and hiding the Control Strip appears in the “Current hot key” window.

- 4 To change the keyboard command, click “Define hot key.”

A box appears.

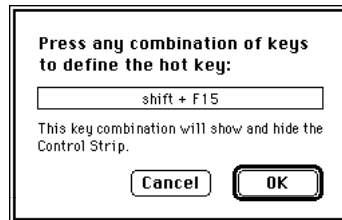

- 5 Press the keys you want to use, then click OK.

You must include either the ⌘ (Command) key or a function key (F1–F15). If you choose an inappropriate command, you see a message.

- 6 Click the close box to close the control panel.

Changing the font in Control Strip menus

When you press a Control Strip control, you see a menu you can use to make changes. You can change the font and size of items in the menu. Follow these steps:

- 1 Choose Control Panels from the Apple () menu.
- 2 Double-click the Control Strip icon to open it.



Control Strip

The Control Strip control panel appears.

- 3** To change the font, choose a font from the Font pop-up menu. To change the font size, choose a size from the Size pop-up menu.

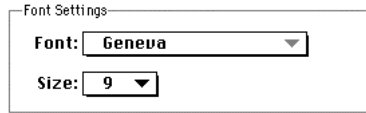

- 4** Click the close box to close the control panel.

3

Adjusting the Picture

In most cases, you won't need to make any adjustments to the picture. However, you can fine-tune the screen display to suit your preferences using the controls on the front of the monitor. After you set the controls, your monitor will use your settings each time you turn on the computer.

Accessing the monitor's controls

A flip-down panel covers some of the controls on the front of the monitor.

- To open the panel so the monitor's controls are accessible, gently push down on the panel. It opens and flips down. You can now use the controls to adjust the picture.
- To close the panel, flip the panel up and gently push it till the door latches.

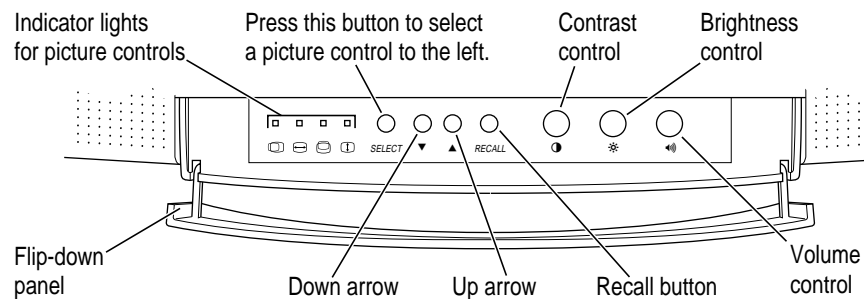

Making adjustments to the picture

Adjusting the brightness of the picture

Turn the brightness control to increase or decrease brightness.

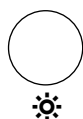

Adjusting the contrast of the picture

Turn the contrast control to increase or decrease contrast.

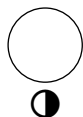

Adjusting the center of the picture

- 1 Press the **Select** button on the monitor until the indicator light for the vertical center icon goes on.

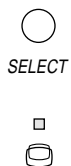

- 2 Adjust the vertical center of the picture by pressing the **Down** button to move the picture down or the **Up** button to move it up.

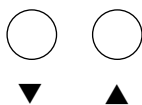

- 3** Press the Select button until the indicator light for the horizontal center icon goes on.



- 4** Adjust the horizontal center of the picture by pressing the Down button to move the center of the picture left or the Up button to move the center of the picture right.

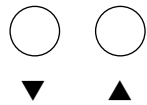

When the picture is centered properly, an equal border appears around the picture.

Adjusting the size of the picture

- 1** Press the Select button on the monitor until the indicator light for the width icon goes on.



- 2** Adjust the width of the picture by pressing the Down button to narrow the picture or the Up button to widen the picture.

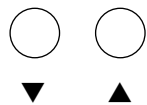

- 3** Press the Select button until the indicator light for the height icon goes on.



- 4** Adjust the height of the picture by pressing the Down button to shorten the picture or the Up button to lengthen the picture.

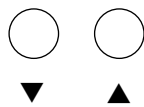

Adjusting the sound volume

Turn the volume control to increase or decrease sound volume.

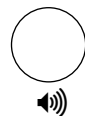

Resetting controls to the factory settings

The picture controls for your monitor are set at the factory. You can fine-tune the picture and make adjustments if necessary. The monitor will use your adjusted settings each time you turn on the computer. If you later decide you want to revert to the factory settings, press the Recall button.



4

Tips and Troubleshooting



This chapter includes information on the care and cleaning of your monitor, protecting your monitor from theft, and troubleshooting.

Care and cleaning

- Do not block the monitor's vents.
- Do not let liquid get on or into the monitor.
- If you will not be using your monitor and computer for a long period of time (a day or more), make sure you turn off the computer (and your monitor, if necessary).

To clean the case of the monitor:

- 1 Turn your computer and monitor off.**
- 2 Disconnect the monitor's power plug from the back of the monitor. (Pull the plug, not the cord.)**
- 3 Wipe the surfaces lightly with a clean, soft cloth dampened with water.**

Don't use aerosol sprays, solvents, or abrasives that might damage the finish on the case.

To clean the screen of the monitor:

- 1 Turn your computer and monitor off.
- 2 Disconnect the monitor's power plug from the back of the monitor. (Pull the plug, not the cord.)
- 3 Use a mild, non-abrasive cleaner on a soft cloth and wipe the screen. Don't spray the cleaner onto the screen, because the liquid may drip inside the monitor.

Protecting your monitor from theft

The slot on the back of the monitor is for connecting a security lock. It lets you attach a narrow, flexible cable that you can use to secure your monitor (and the rest of your computer system) to prevent theft. Security locks are available from an Apple-authorized dealer or service provider.

Troubleshooting

WARNING If you have a problem with your monitor and nothing presented in this manual solves it, consult the service and support information that came with your monitor for instructions on how to contact an Apple-authorized service provider or Apple for assistance. If you attempt to repair the monitor yourself, any damage you may cause to the monitor will not be covered by the limited warranty on your monitor. Contact an Apple-authorized dealer or service provider for additional information about this or any other warranty question.

Solutions to common problems related to your monitor are described here. Problems related to the computer are covered in the manuals that came with your computer.

WARNING Never remove the cover from the monitor; you could come in contact with hazardous voltage.

The monitor's power indicator light doesn't come on.

- Make sure the monitor is turned on.
- Make sure that the power cord is plugged in properly.

If the monitor power cord is plugged into a wall outlet, make sure the cord is firmly plugged in. Check whether power to the outlet has been interrupted. You can test the outlet by plugging in something that you know works—such as a desk lamp or radio. If the test appliance works, but the monitor doesn't, contact an Apple-authorized dealer or service provider.

If the monitor power cord is plugged into your computer, make sure your computer is on and the cord is firmly plugged in.

- Make sure the monitor cable is plugged into your computer properly.

If you have a video card installed in your computer, the monitor cable should be plugged into the port for the video card.

If you do not have a video card installed in your computer, the monitor cable should be plugged into the monitor port on the back of your computer.

- Make sure the thumbscrews on the monitor cable are tightened securely into the port connector.

No image appears on the screen and the monitor's power indicator light is on.

- The monitor may have gone to sleep. Move the mouse or press a key to wake the monitor. (See “Conserving Energy” in Chapter 3.)
- Make sure the monitor cable is connected to the correct port on the back of the computer.

If you have a video card installed in your computer, the monitor cable should be plugged into the port for the video card.

If you do not have a video card installed in your computer, the monitor cable should be plugged into the monitor port on the back of your computer.

- Make sure the thumbscrews on the monitor cable are tightened securely into the port connector.
- Make sure the brightness (☼) and contrast (●) controls are set correctly. See “Adjusting the Brightness of the Picture” and “Adjusting the Contrast of the Picture” in Chapter 3.

- *If the power indicator light is yellow or amber, one of the following may be the cause:*
 - The computer isn't turned on.
 - The monitor's cable isn't connected properly to the computer.
 - The video circuitry or video card in your computer is not compatible with the monitor. Your Macintosh may need a video card or adapter to use the monitor. See “Do You Need a Video Card?” in Chapter 1.
 - The computer and monitor are in sleep to conserve energy. See “Conserving Energy” in Chapter 2.

The screen is dark or appears dim.

- Make sure that your computer and monitor are turned on.
- Make sure that the power cord and the monitor cable are securely connected.
- Increase the brightness (☼) and contrast (●) of the picture. See “Making Adjustments to the Picture” in Chapter 3.
- The Energy Saver option may be activated. Move the mouse or press any key on the keyboard to reactivate the monitor. In approximately 20 seconds (or until you no longer hear the beep), the monitor is reactivated.
- A screen saver that darkens your screen may be activated. Move the mouse or press any key on the keyboard to reactivate the monitor.

The screen flickers.

- Make sure the monitor cable is connected firmly to the correct port on the back of the computer.

If you have a video card installed in your computer, the monitor cable should be plugged into the port for the video card.

If you do not have a video card installed in your computer, the monitor cable should be plugged into the monitor port on the back of your computer.
- The flickering could be caused by interference from a nearby power line, a fluorescent light, or electrical device—for example, a radio, a microwave oven, or another computer. Try relocating nearby electrical devices or moving your computer and monitor.

- If you have more than one monitor attached to your computer, the monitors may interfere with one another. Move the monitors farther apart or set the monitors at an angle, so their screens are close and their back panels are farther apart. If you still see flickering after moving the monitors more than 16 inches apart, contact an Apple-authorized dealer or service provider.
- If you are using a video card that has a very low refresh rate (below 60 hertz), the monitor may flicker. You may be able to change the refresh rate for the card. See the documentation that came with your video card for more information.

No colors appear on the screen.

- Make sure that the number of colors is set correctly in the Control Strip or control panel. See “Using the Control Strip” in Chapter 2, and see the on-screen help that came with your computer.

The screen image is off center.

- Try changing to another resolution. See “Changing Screen Resolution” in Chapter 2.
- Adjust the center of the picture. See “Adjusting the Center of the Picture” in Chapter 3. (Keep in mind that if you adjust the center of the picture, you may have to adjust it again if you change resolutions.)

The screen image is too large or too small.

- Try changing to another resolution. See “Changing Screen Resolution” in Chapter 2.
- Adjust the horizontal or vertical size of the picture. See “Adjusting the Size of the Picture” in Chapter 3. (Keep in mind that if you adjust the horizontal or vertical size of the picture, you may have to adjust it again if you change resolutions.)

Before you finish adjusting the monitor controls, the picture control indicator light goes out.

- If you pause for several seconds while adjusting the controls, the monitor assumes you are finished.

The screen appears greenish, the screen image is unreadable, or there is “snow” on the screen.

- Make sure the monitor cable is connected firmly to the correct port on the back of the computer.

If you have a video card installed in your computer, the monitor cable should be plugged into the port for the video card.

If you do not have a video card installed in your computer, the monitor cable should be plugged into the monitor port on the back of your computer.

After many hours of use, the screen image appears dim.

- Increase the brightness (☼) and contrast (●) of the picture. See “Making Adjustments to the Picture” in Chapter 3.

Over time, you experience eyestrain.

- Adjust the screen contrast (●). In a bright room, contrast is usually best set at maximum; in a dim room, lower contrast is usually more comfortable. See “Adjusting the Contrast of the Picture” in Chapter 3. Also, be sure to take occasional breaks to focus your eyes on a distant object.

You don’t hear any sound from your computer.

- Make sure sound is turned on and make sure your sound options are set correctly in the Control Strip or control panel for sound. See “About the Control Strip” in Chapter 2 and see the on-screen help that came with your computer or system software upgrade kit.
- Adjust the sound volume on your monitor. See “Adjusting the Sound Volume” in Chapter 3.
- Check whether headphones are plugged into the headphone port (marked by 🎧) on the monitor. If so, you will be able to hear sound only in the headphones.
- Check whether something is plugged into the sound output port (marked by 🔊) on the back panel of your computer. The computer’s internal speaker is turned off whenever a cable is connected to the sound output port. If a sound cable is connected between the computer and monitor, you can hear sound from the monitor’s speakers or from headphones connected to the monitor’s headphone port (marked by 🎧). For more information, see Chapter 1, “Setting Up.”

You can’t find the Control Strip.

- You may have hidden the Control Strip. Open the Control Strip control panel and click the button labeled Show Control Strip.

After you change the screen resolution, icons move.

Changing the screen resolution affects how information can be displayed on your screen. The display software may automatically reposition icons after you change the screen resolution.

After you attached a new monitor to your computer, the new monitor's screen is blank or shows "garbage" or "snow."

The computer may not have recognized the monitor. Try the following: Turn off the computer and disconnect the new monitor. Start the computer with no monitor attached. Wait a minute or so for the computer to finish turning itself on. Turn off the computer again and reattach the new monitor.

The monitor does not go to sleep.

Some computers and video cards do not support the Energy Saver feature. See the documentation that came with your computer and video card for more information.

If you have a Power Macintosh 9500, you can get an upgrade to your software that allows your monitor to work with Energy Saver. Call the Apple Service and Support number found in the service and support information that came with your computer.

When you use both Energy Saver and a screen saver program, the screen freezes.

The screen saver program may be conflicting with Energy Saver. Turn off either the screen saver program or the Energy Saver control panel.

You see two resolution options labeled 640x870 (75 Hz).

If you're using the Macintosh 24AC video card, you may see two apparently identical resolution selections. The first option sets your monitor to display millions of colors, and the second option sets your monitor to display 256 colors.

When you change resolutions, the monitor goes blank.

If your monitor is connected to the Macintosh 24AC video card, the monitor may go blank for 15 seconds when you select a resolution that does not work with your monitor. Try selecting another resolution.



Appendix Technical Information

• • • • •

Monitor features

- Multiple scan
- Resolution range: 640 x 480 to 1024 x 768

Screen

- 15-inch diagonal CRT, 13.75-inch diagonal viewable image size
- Antistatic, antiglare surface treatment
- 0.28 millimeter (mm) dot pitch

Input signals

- Red, green, and blue signals; separate sync

Power-saving feature

- Conforms to the Energy Star program of the United States Environmental Protection Agency
- Power-saving feature compatible with the Video Electronics Standards Association's (VESA) Display Power Management Standard (DPMS)

User controls

- Power-on switch
- Automatic degauss at power-up; manual degauss by turning power switch off, then on (capable of full degauss after monitor is turned off for 20 minutes or more)
- Buttons and controls: Select, Up, Down, brightness, contrast, sound volume
- Additional picture controls available using the Select button: horizontal and vertical shift, horizontal and vertical size

Active video image area

- Adjusted at the factory for the following standard modes:

Mode	Resolution	Vertical refresh rate (hertz)	Horizontal scan rate (kilohertz)
VGA	640 x 480	60	31.77
Macintosh	640 x 480	66.67	35.0
SVGA	800 x 600	60	37.9
SVGA	800 x 600	72	48.1
Macintosh	832 x 624	75	49.7
Macintosh	1024 x 768	75	60.2

Input electrical requirements

- Voltage 100–240 volts (V)
- Frequency 50/60 hertz (Hz)
- Power 75 watts (W) maximum



Monitor cable specifications

- 15-pin miniature D-type connector

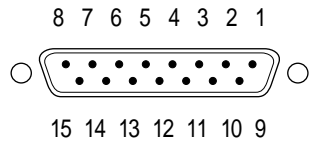

Pin	Output signal
1	Red video ground
2	Red video
3	Not used
4	ID 1
5	Green video
6	Green video ground
7	ID 2
8	Not used
9	Blue video
10	ID 3
11	V Sync return
12	V Sync
13	Blue video ground
14	H Sync return
15	H Sync
Shell	Shield ground



Apple Computer, Inc.

1 Infinite Loop

Cupertino, California 95014-2084

408.996.1010

030-8471-A

Printed in Taiwan