



PowerBook **Duo**

Getting Started

*Setup and important health-related information
for the PowerBook **Duo** notebook computers*

 Apple Computer, Inc.

© 1994 Apple Computer, Inc. All rights reserved.

Under the copyright laws, this manual may not be copied, in whole or in part, without the written consent of Apple. Your rights to the software are governed by the accompanying software license agreement.

The Apple logo is a trademark of Apple Computer, Inc., registered in the U.S. and other countries. Use of the “keyboard” Apple logo (Option-Shift-K) for commercial purposes without the prior written consent of Apple may constitute trademark infringement and unfair competition in violation of federal and state laws.

Every effort has been made to ensure that the information in this manual is accurate. Apple is not responsible for printing or clerical errors.

Apple Computer, Inc.
1 Infinite Loop
Cupertino, CA 95014-6299
(408) 996-1010

Apple, the Apple logo, AppleShare, AppleTalk, EtherTalk, LaserWriter, LocalTalk, Macintosh, PowerBook, and StyleWriter are trademarks of Apple Computer, Inc., registered in the U.S. and other countries.

AppleColor, Apple Desktop Bus, Disk First Aid, Finder, Macintosh PC Exchange, and PowerBook Duo are trademarks of Apple Computer, Inc.

Adobe, Adobe Illustrator, Adobe Photoshop, and PostScript are trademarks of Adobe Systems Incorporated, which may be registered in certain jurisdictions.

Aldus, PageMaker, and SuperPaint are registered trademarks of Aldus Corporation.

Canvas is a trademark of Deneba Software.

CompuServe is a registered service mark of CompuServe, Inc.

Exposure is a registered trademark of Preferred Publishers, Inc.

Helvetica and Times are registered trademarks of Linotype Company.

Lotus is a registered trademark of Lotus Development Corporation.

Macintosh Basics was developed using VideoWorks Interactive. MacroMind is a registered trademark, and VideoWorks is a trademark of Macromedia, Inc. (formerly MacroMind, Inc.).

MacDraw and MacWrite are registered trademarks, and Claris Resolve is a trademark, of Claris Corporation.

Microsoft is a registered trademark, and Windows is a trademark, of Microsoft Corporation.

NuBus is a trademark of Texas Instruments.

QMS is a registered trademark of QMS, Inc.

QuarkXPress is a registered trademark of Quark, Inc.

Quattro is a trademark of Borland International, Inc.

Tektronix is a registered trademark of Tektronix, Inc.

Trinitron is a registered trademark of Sony Corporation.

Ventura Publisher is a registered trademark of Ventura Software, Inc.

WordPerfect is a registered trademark of WordPerfect Corporation.

WriteNow is a registered trademark of T/Maker Company.

Simultaneously published in the United States and Canada.

Mention of third-party products is for informational purposes only and constitutes neither an endorsement nor a recommendation. Apple assumes no responsibility with regard to the performance or use of these products.



Contents



Communications regulation information vii

1 Setting Up Your PowerBook Duo 1

Step 1 Plug in the power adapter 1

Step 2 Open the display 3

Step 3 Turn on the computer 4

What to do next 6

Turning your computer off 7

Putting your computer to sleep 7

Restarting a computer that's already on 8

2 Learning to Use Your Computer 9

Part 1 Starting the *Macintosh Basics* tour 10

Part 2 Practicing your new skills 15

Answers to the review questions 19

Practice session 21

Clues on your screen 29

3	Basic Skills	31
	Working with icons	32
	Working with windows	34
	Working with documents	36
	Working with disks	38
	Organizing your desktop	39
	Working with pull-down menus	40
	Keyboard shortcuts in the Finder and in directory dialog boxes	40
4	Health, Safety, and Maintenance Tips	41
	Important care and safety instructions	41
	Caring for batteries	43
	Health-related information about computer use	44
5	The Control Strip	49
	What is the Control Strip?	49
	How does the Control Strip differ from control panels?	50
	Closing, opening, and resizing the Control Strip	50
	Hiding the Control Strip	51
	Moving the Control Strip	52
	Rearranging the modules in the Control Strip	52
	Using the Control Strip	52
6	Power Management	59
	Power sources	59
	Monitoring the battery charge level	59
	Responding to low-power messages	61
	Recharging the battery	62
	Removing or replacing the battery	65
	Disposing of dead batteries	66
	Replacing the backup battery	67
	Reconditioning the battery	67
	Maximizing work time	70

7	Customizing and Traveling With Your PowerBook	77
	Customizing your PowerBook	77
	Traveling with the PowerBook	87
	Storing the PowerBook	88
	Service and support	88
8	Building a PowerBook Duo System	89
	The PowerBook Duo Dock and Duo Dock II	89
	The PowerBook Duo MiniDock	92
	The PowerBook Duo Floppy Adapter	93
	Using other equipment with your Duo system	94
9	Using SCSI Devices	99
	Connecting SCSI devices	99
	Using your PowerBook as a SCSI disk	104
	Quitting SCSI disk mode	108
10	Tips and Troubleshooting	109
	The PowerBook Duo	110
	Power	112
	The screen	114
	The trackball	116
	Memory	116
	The Duo Dock	117
	The Duo MiniDock	118
	SCSI devices	119
	Disk drives and disks	120
	Modems	122
	Printers	122
	Networks	124
	Application programs	125

Appendix A	Installing System Software	127
	Before you begin	128
	Installing system software for the first time	128
	Reinstalling system software	131
	Installing customized system software	133
Appendix B	Using the PowerBook File Assistant	135
	What is file synchronization?	135
	Starting the PowerBook File Assistant	136
	Linking files or folders for synchronization	136
	Synchronizing linked folders or files	141
	Understanding the alert messages	143
	Setting up completely automatic synchronization	144
Appendix C	Exchanging Files with DOS or Windows	145
	Macintosh PC Exchange at a glance	145
	Using DOS-format disks on your Macintosh	146
	Opening DOS documents on your Macintosh	149
	Assigning Macintosh programs to DOS documents	150
	Saving documents onto a DOS-format disk	159
	Index	163

Communications regulation information

FCC statement

This equipment has been tested and found to comply with the limits for a Class B digital device in accordance with the specifications in Part 15 of FCC rules. See instructions if interference to radio or television reception is suspected.

Radio and television interference

The equipment described in this manual generates, uses, and can radiate radio-frequency energy. If it is not installed and used properly—that is, in strict accordance with Apple’s instructions—it may cause interference with radio and television reception.

This equipment has been tested and found to comply with the limits for a Class B digital device in accordance with the specifications in Part 15 of FCC rules. These specifications are designed to provide reasonable protection against such interference in a residential installation. However, there is no guarantee that interference will not occur in a particular installation.

You can determine whether your computer system is causing interference by turning it off. If the interference stops, it was probably caused by the computer or one of the peripheral devices.

If your computer system does cause interference to radio or television reception, try to correct the interference by using one or more of the following measures:

- Turn the television or radio antenna until the interference stops.
- Move the computer to one side or the other of the television or radio.
- Move the computer farther away from the television or radio.
- Plug the computer into an outlet that is on a different circuit from the television or radio. (That is, make certain the computer and the television or radio are on circuits controlled by different circuit breakers or fuses.)

If necessary, consult an Apple-authorized service provider or Apple. See the service and support information that came with your Apple product. Or, consult an experienced radio/television technician for additional suggestions. You may find the following booklet helpful: *Interference Handbook* (stock number 004-000-00493-1). This booklet, prepared by the Federal Communications Commission, is available from the U.S. Government Printing Office, Washington, DC 20402.

IMPORTANT Changes or modifications to this product not authorized by Apple Computer, Inc., could void the FCC Certification and negate your authority to operate the product.

This product was tested for FCC compliance under conditions that included the use of Apple peripheral devices and Apple shielded cables and connectors between system components. It is important that you use Apple peripheral devices and shielded cables and connectors between system components to reduce the possibility of causing interference to radios, television sets, and other electronic devices. You can obtain Apple peripheral devices and the proper shielded cables and connectors through an Apple-authorized dealer. For non-Apple peripheral devices, contact the manufacturer or dealer for assistance.

DOC statement

DOC Class B Compliance This digital apparatus does not exceed the Class B limits for radio noise emissions from digital apparatus as set out in the interference-causing equipment standard entitled “Digital Apparatus,” ICES-003 of the Department of Communications.

Observation des normes—Classe B Cet appareil numérique respecte les limites de bruits radioélectriques applicables aux appareils numériques de Classe B prescrites dans la norme sur le matériel brouilleur : “Appareils Numériques”, NMB-003 édictée par le ministre des Communications.

VCCI statement

情報処理装置等電波障害自主規制について

この装置は、第二種情報装置（住宅地域又はその隣接した地域において使用されるべき情報装置）で住宅地域での電波障害防止を目的とした情報処理装置等電波障害自主規制協議会（VCCI）基準に適合しております。

しかし、本装置をラジオ、テレビジョン受信機に近接してご使用になると、受信障害の原因となることがあります。

取扱説明書に従って正しい取り扱いをしてください。



Follow the steps in this chapter to set up your PowerBook Duo, and learn about turning your computer on and off.

1

Setting Up Your PowerBook Duo



To set up your PowerBook Duo for the first time, you need the power adapter and the power cord that came with your PowerBook.

Step 1 Plug in the power adapter

When you plug in the power adapter, the computer's battery recharges. You should plug the power adapter in now in case the battery has drained during shipping and storage.

WARNING Use only a PowerBook Duo power adapter with your PowerBook computer. Adapters for other electronic devices (including other portable computers) may look similar, but they may damage your computer.

Your computer's power adapter comes with a detached power cord.

- 1 Plug one end of the power cord into the power adapter and the other end into a three-hole grounded outlet or power strip.

WARNING Your PowerBook is equipped with a three-wire grounding plug—a plug that has a third (grounding) pin. This plug is a safety feature, and is meant to fit only a grounded AC outlet. If you are unable to insert the plug into an outlet, contact a licensed electrician to replace the outlet with a properly grounded outlet.

- 2 Plug the power adapter cable into the power adapter port on the back panel of the computer.

If the cable is too long, you can wind it around the hooks that open out from the power adapter.

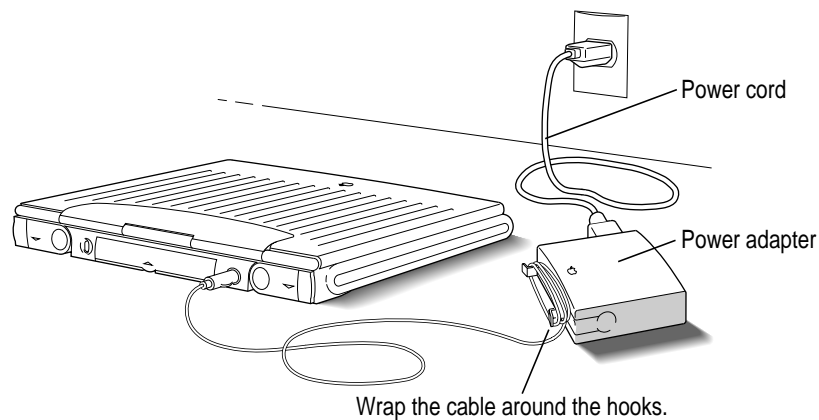

Depending on where you purchased your computer, you may also have received a wall mount plug. You can use this plug instead of the power cord to plug the power adapter directly into an electrical outlet.

Step 2 Open the display

- Slide the latch to the right and lift up the display.

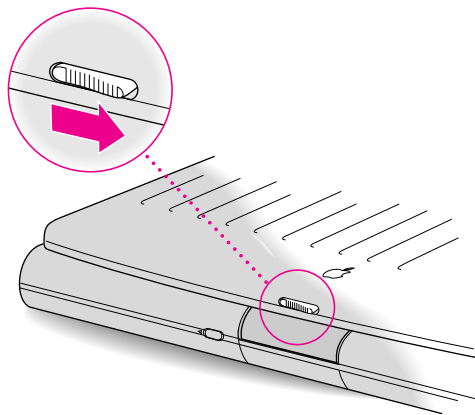

Position the display at a comfortable viewing angle. You can adjust the angle of the display at any time.

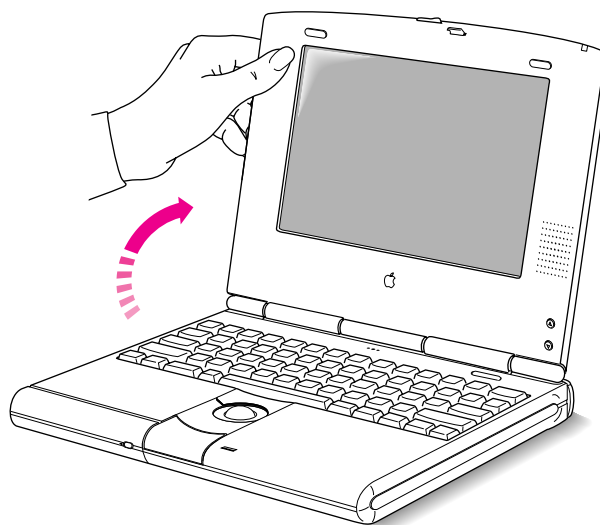

Step 3 Turn on the computer

- Turn on the computer by pressing the Power On key above the keyboard.

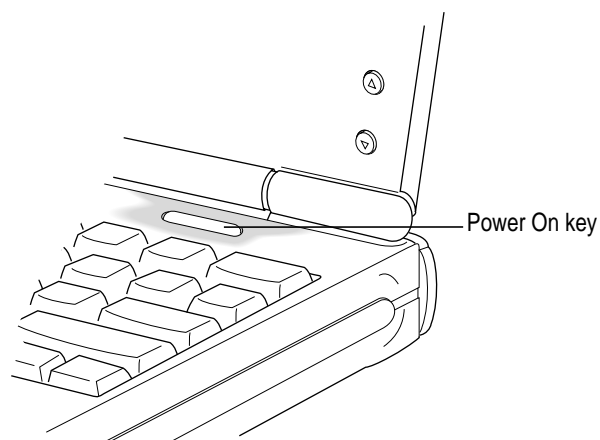

You hear a tone when you turn on the computer. It takes the computer a moment to start up.

When you see something like this on your screen, the computer is ready to use:

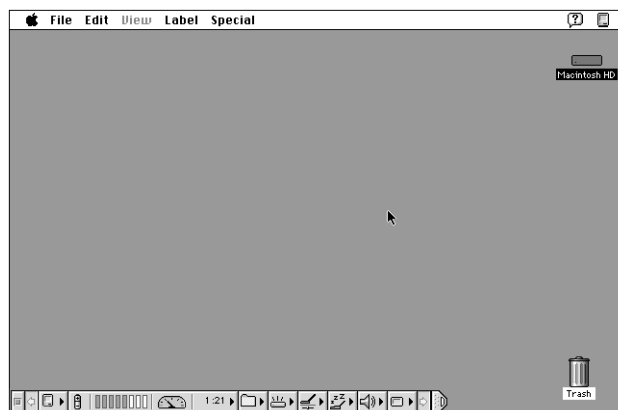

Note: Your screen should look very similar to this picture but it might not look exactly the same.

Problems turning on your computer?

- **The computer made a sound, but you can't see anything on the screen.**

Use the brightness control buttons and contrast control buttons (if your computer has them) to adjust the screen. (Some models have brightness control buttons only.)

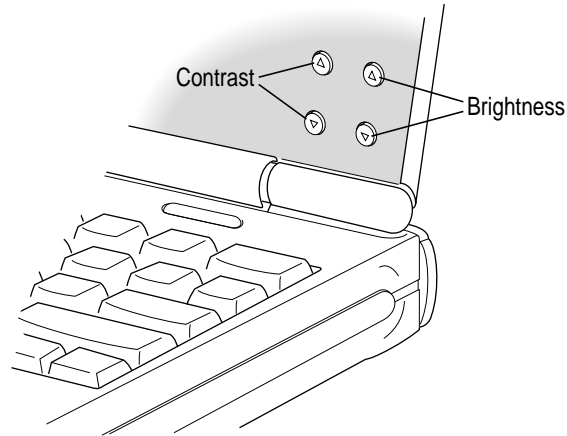

- **Nothing happened when you pressed the Power On key.**

Make sure the power adapter is firmly connected to both the computer and a power source. If the power adapter is plugged into a power strip, make sure the power strip is plugged in and turned on. Then try pressing the Power On key again.

If you still get no results, press the power button on the back of the computer.

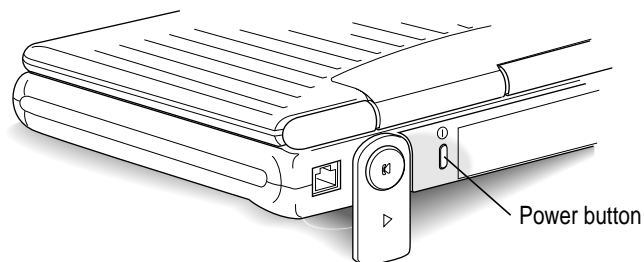

If neither the Power On key nor the power button turns the computer on, see Chapter 10, “Tips and Troubleshooting,” for help.

- You see a picture of a disk with a blinking question mark on the screen.



This picture means that you need to install system software on the computer's hard disk. System software includes the programs the computer uses to start itself up. You received a set of system software disks in the box with your computer. For instructions on installing system software, see Appendix A in this book.

What to do next

- **New Macintosh users:** If you have never used a Macintosh computer before, go to *Chapter 2 now* to learn how to use your PowerBook. Then go to Chapter 4 for important health and safety instructions. For help turning your PowerBook off, or putting your PowerBook to sleep, come back to this chapter once you have learned to use your PowerBook.
- **New PowerBook users:** If you have used other Macintosh computers but are new to the PowerBook, read the rest of this chapter for instructions on turning the PowerBook off and putting the PowerBook to sleep. Then go to Chapter 5 to learn about using the Control Strip. Make sure you read Chapter 4 for important health and safety instructions.
- **Experienced PowerBook users:** Skim this book for information about your new PowerBook. Important health and safety instructions are in Chapter 4.

Turning your computer off

- *If the computer is on*, choose Shut Down from the Special menu.



- *If the computer is in sleep*, wake it by pressing any key on the keyboard (except Caps Lock), and then choose Shut Down.
- *If a problem with the computer prevents you from choosing Shut Down*, press the power button on the back of the computer. This turns off the power and you will lose any unsaved work. Use the power button only in an emergency.

Putting your computer to sleep

When the PowerBook is in sleep, it has a darkened screen and appears to be off, though it is still drawing battery power at a low level. The computer is on, but almost completely inactive. To put your PowerBook to sleep:

- If the computer is on, choose the Sleep command from the Special menu.



- You can also put the computer to sleep by closing the display.

Note: If you have a PowerBook Duo 280c, a green light flashes on the upper right of the display when your computer is in sleep.

Automatic sleep

If you don't use the computer for several minutes, it goes to sleep automatically (unless you change the sleep preferences). This conserves battery power.

To wake the computer, press any key on the keyboard (except Caps Lock). In a few seconds, the screen will go back to the way it looked before the computer went to sleep.

For more information on sleep and automatic sleep, see Chapter 6.

Restarting a computer that's already on

You need to restart your computer—turn it off and back on again immediately—when you want to make certain changes to your control panels, use a newly installed system software file, or start up the computer from a different disk. You also need to restart if you see a “system error” message on the screen (indicating a temporary software problem). In this case, use the trackball to click the Restart button that appears.

To restart your computer:

- **Choose Restart from the Special menu.**



When you choose Restart, the computer prompts you to save your work, closes all open programs, and restarts itself.

Choosing Restart does not affect your RAM disk (if you created one) or its contents.

Go through the exercises in this chapter to learn how to use your computer

2

Learning to Use Your Computer



Your computer comes with a tutorial that teaches you the basics. The tutorial is divided into two parts:

- **Part 1** You start the *Macintosh Basics* tour on your computer, which presents the basic skills you need to master.
- **Part 2** After you complete the *Macintosh Basics* tour, you return to this chapter to practice what you learned. You also learn some additional skills.

If you've never used a Macintosh computer before, you should complete both parts of the tutorial.

If you are an experienced Macintosh user, you may want to look over the rest of this book to learn about special features of this computer. Then, as you work with your Macintosh, consult the *Macintosh Reference* book for answers to questions about the system software that came with your computer.

IMPORTANT If you need to turn off your computer at any point before finishing the tutorial, please see “Turning Your Computer Off” in Chapter 1.

Part 1 Starting the *Macintosh Basics* tour

Your *Macintosh Basics* tour is on the hard disk that's inside your computer. To take the tour, follow the steps in this section.

Make sure your computer is turned on. If the screen is dark, try adjusting the screen (see “Problems Turning On Your Computer?” in Chapter 1) until you see words and small pictures on your screen.

1 Roll the trackball to move the arrow pointer (␣) around on the screen.

Place your index finger on the trackball and your thumb on the lower trackball button. Don't press either button yet.

Roll the trackball, watching the arrow on the screen. Notice that the arrow moves in the same direction as you roll the trackball.

You may need to roll the trackball around for a few seconds to “break in” the mechanism so it works smoothly.

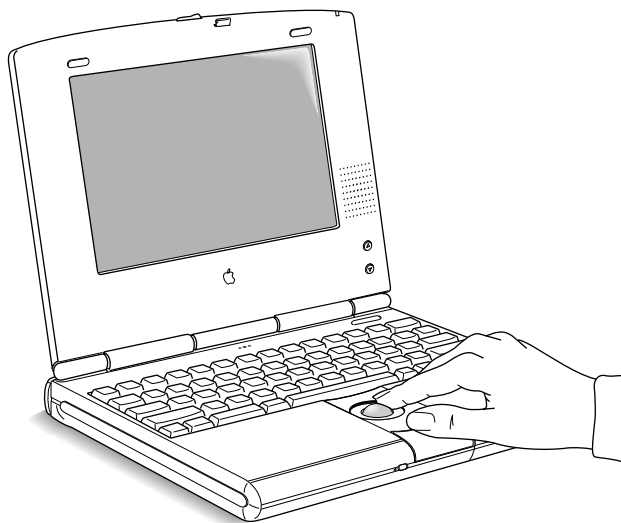

- 2 Notice the Control Strip at the bottom of your screen.

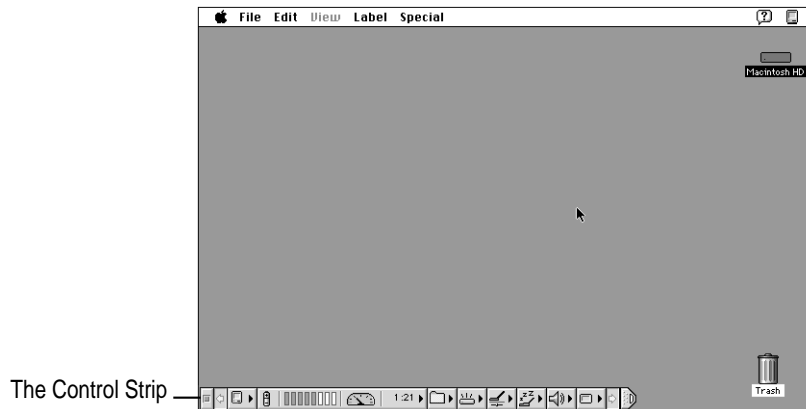

The Control Strip is the line of pictures at the lower left of your screen. You'll learn more about the Control Strip in Chapter 5.

- 3 Roll the trackball so that the tip of the arrow is on the tab at the right end of the Control Strip.

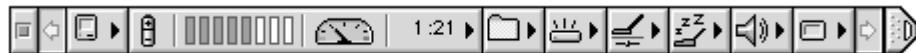

- 4 Being careful not to move the trackball, press the button once.

The Control Strip closes and only the tab appears in the lower-left corner of the screen.

5 Roll the trackball so that the tip of the arrow is on the picture labeled “Macintosh HD.”

Make sure the tip of the arrow is over the picture, not over the words “Macintosh HD.”

Note: Your screen should look similar to the one below, but may not look exactly the same.

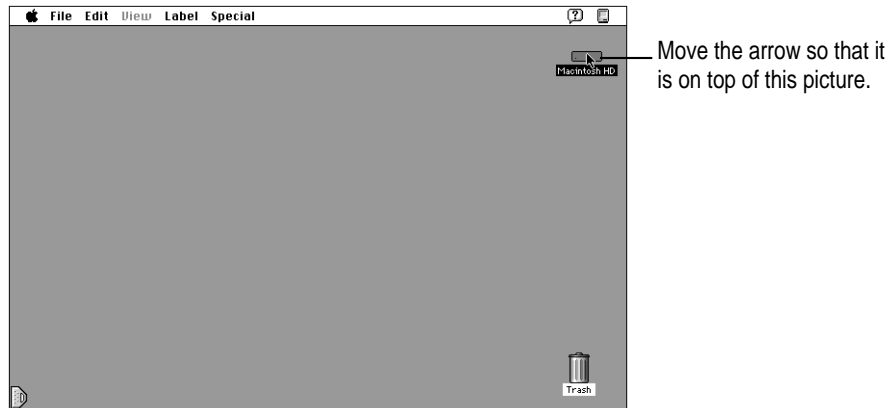

Different name? The picture on your screen may be labeled “PowerBook HD” instead of “Macintosh HD.” The different name is not important; you can still follow directions in this manual by replacing references to “Macintosh HD” with “PowerBook HD.”

6 Being careful not to roll the trackball, press the button twice in quick succession. (This is called “double-clicking.”)

Now your screen should look like the illustration following step 7. The items in that illustration may not exactly match those on your screen. The only item you need right now is the Macintosh Basics folder.

If the screen doesn’t look right, try steps 5 and 6 again, paying special attention to the following:

- Make sure the tip of the arrow is touching the picture, not the words beneath it.
- Be sure to press the trackball button twice.
- Press twice quickly and be careful not to roll the trackball while you press.

- 7** Roll the trackball to place the tip of the arrow on the picture of the folder labeled “Macintosh Basics.”

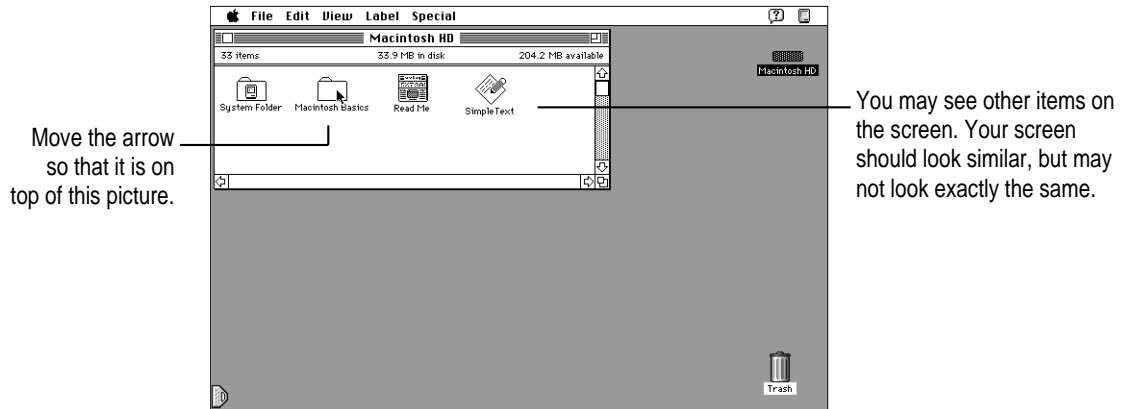

- 8** Being careful not to roll the trackball, press the button twice in quick succession.

Now your screen should look like the following illustration:

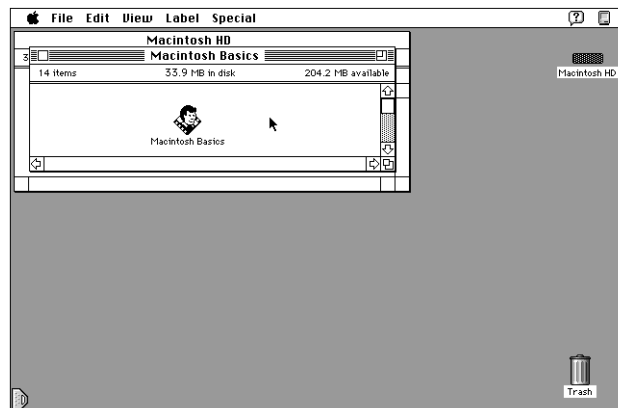

- 9** Roll the trackball so that the arrow is on the picture of the man labeled “Macintosh Basics.”

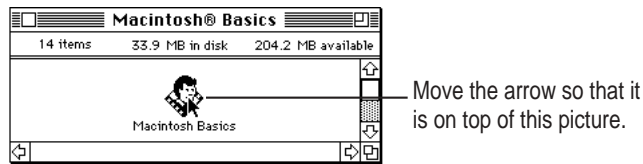

- 10** Press the trackball button twice in quick succession.

Now your screen should look like the following picture:

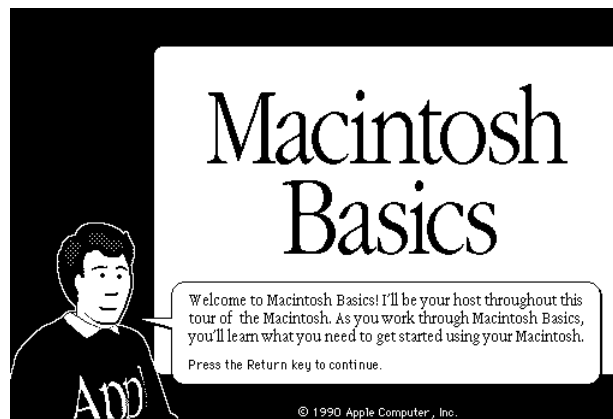

If you don't see this screen, try again, paying special attention to the following:

- Make sure the tip of the arrow is touching the picture, not the words beneath it.
 - Be sure to press the trackball button twice.
 - Press twice quickly and be careful not to roll the trackball while you press.
- 11** Follow the instructions on the screen and work through the tour.

When you finish the tour, continue with the rest of this chapter.

Part 2 Practicing your new skills

You should now have completed the *Macintosh Basics* tour.

The second part of your training gives you an opportunity to think about what you've learned so far and to practice your new skills.

Reviewing what you've learned

Before continuing, take a few moments to answer these questions. They will help you summarize the information you learned in *Macintosh Basics*. You may want to write (or circle) your answers as appropriate. The correct answers are in the next section of this chapter.

If you have any trouble answering the questions, look in Chapter 3, "Basic Skills."

Question: *What is the name of the area where you do all your work? (It's shown below.)*

Answer: _____



Question: *What are pictures on the Macintosh desktop called? Two examples are shown below.*

Answer: _____



What is the name for these pictures on the Macintosh desktop?

Circle the hard disk *window* in the illustration below.

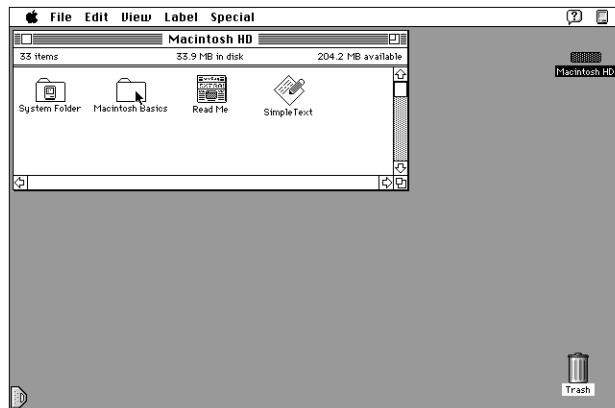

Circle the hard disk *icon* in the illustration below.

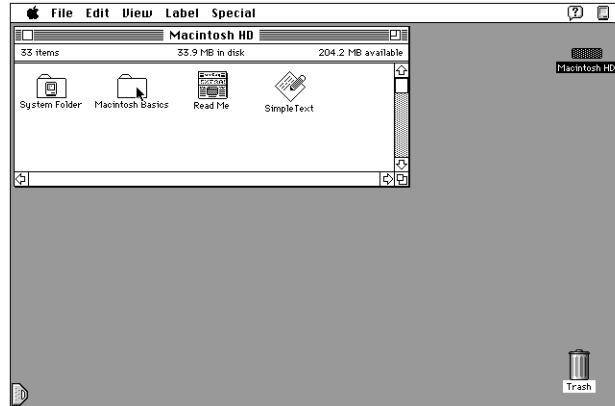

Question: Circle the active window on the desktop below. How do you make a window active?

Answer: _____

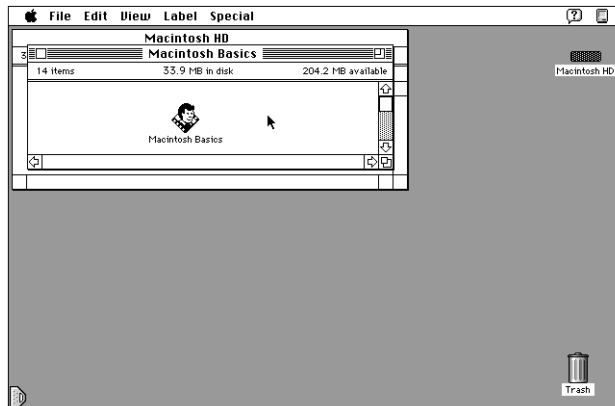

Question: Which menu is the Save command in?

Answer: _____

Question: How do you throw an item away?

Answer: _____

Label the parts of this window.

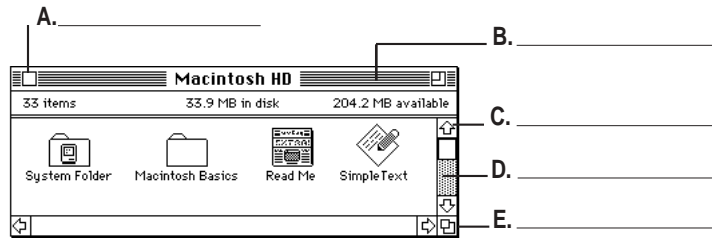

Answers to the review questions

These are the answers to the review questions that you completed earlier.

Question: *What is the area called where you do all your work?*

Answer: *the desktop*

Question: *What are pictures called on the Macintosh desktop?*

Answer: *icons*

Circle the hard disk *window* in the illustration below.

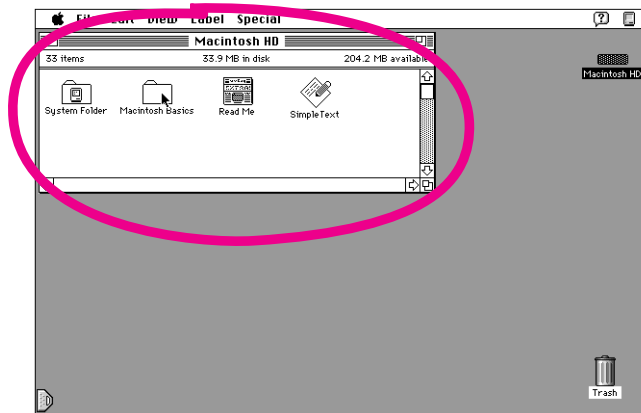

Circle the hard disk *icon* in the illustration below.

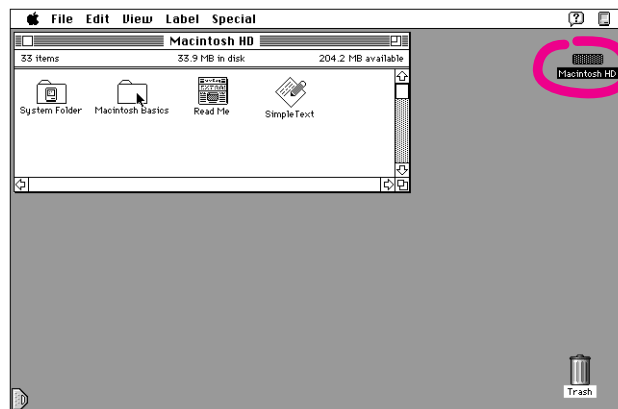

Question: Circle the active window shown on the desktop below. How do you make a window active?

Answer: by clicking anywhere inside of it

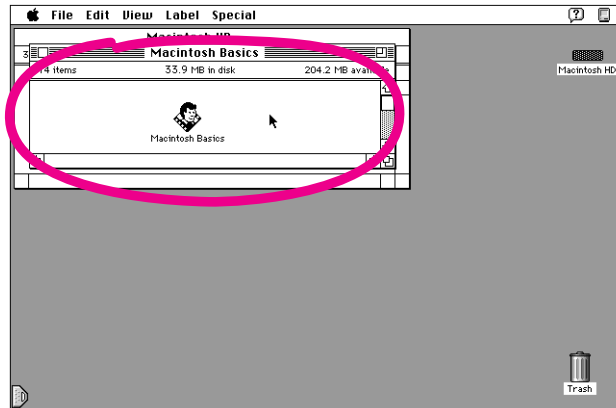

Question: Which menu is the Save command in?

Answer: the File menu

Question: How do you throw an item away?

Answer: by dragging it to the Trash

Label the parts of this window.

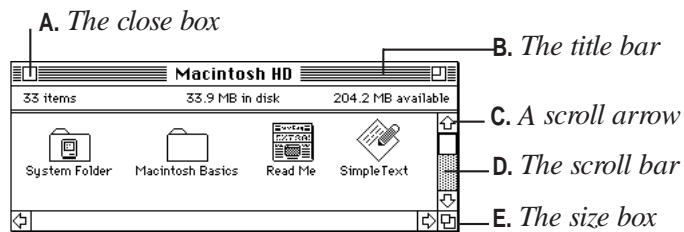

Practice session

Now you can practice what you learned in *Macintosh Basics*. You'll be practicing your skills using real programs that came with your computer, rather than the sample ones in *Macintosh Basics*.

IMPORTANT If you get lost at any point during the practice session, or if something unexpected happens, please turn to “Clues on Your Screen” in this chapter. These clues will help you get back on track.

1: Creating a new document

- 1 Open the hard disk icon and then open the SimpleText program, as shown below.

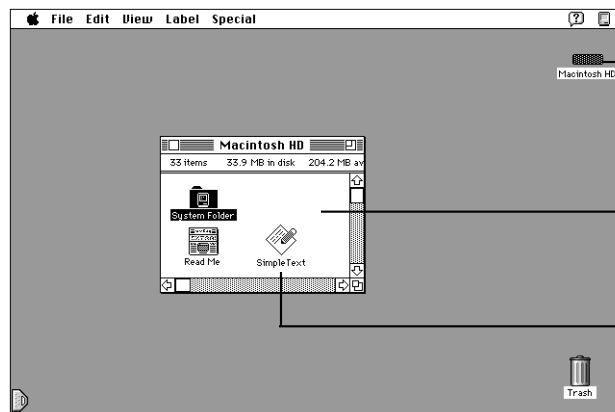

1 Double-click the hard disk icon to open it.

2 If a window with the name of your hard disk doesn't appear, click the disk icon again twice.

3 To open the SimpleText program, double-click the SimpleText icon.

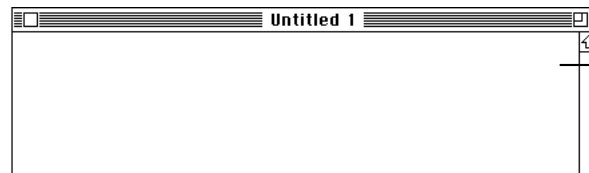

When the SimpleText program opens, a window appears with "Untitled 1" in the title bar. This is your blank document.

2 Use the keyboard to type a few lines of text into the blank document.

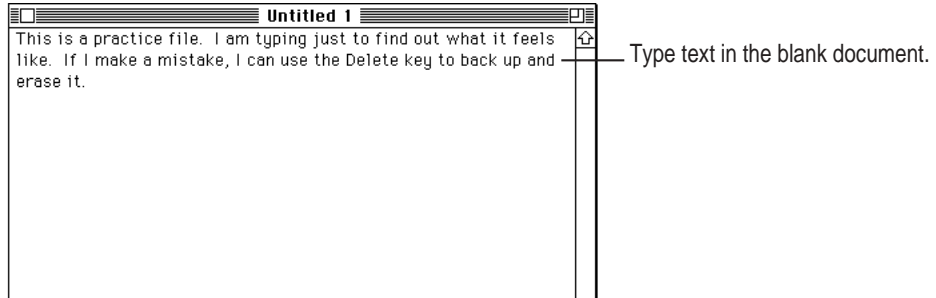

It doesn't matter what you type. If you make an error, press the Delete key to backspace over the incorrect letters, then retype.

3 Open the File menu and choose the Save command to save your new document.

When you save a document, you are storing it on the hard disk. You need to save every document you create. If you don't save it, the document is lost when you turn off the computer.

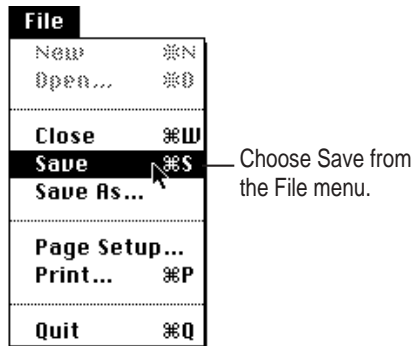

A box like the one in the next step appears, with "Untitled 1" near the bottom. This box lets you name and save your document.

- 4 Don't click anywhere. Just type the name "Practice File." Then click the button labeled Save.

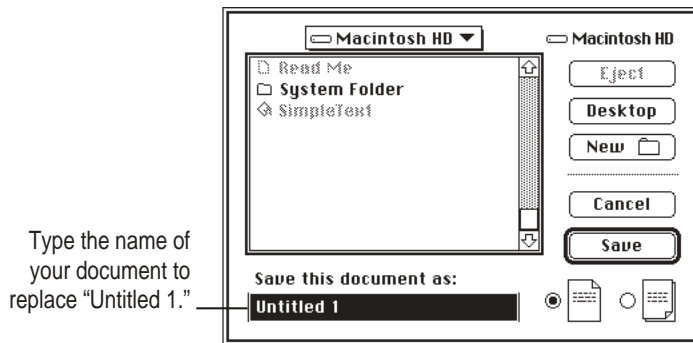

The name you type should replace "Untitled 1" in the box. If it doesn't, place the pointer to the left of the *U* in "Untitled 1," then press the trackball button and drag across the word. When "Untitled 1" is *highlighted* (the text is surrounded with a black box), type the new name.

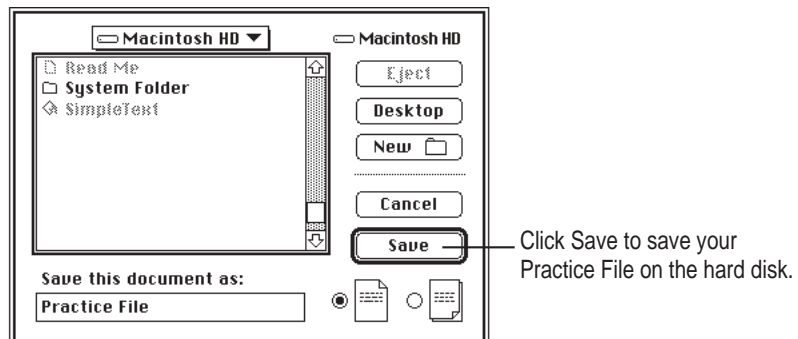

After you click Save, a copy of your document is stored on the hard disk in your computer. The new name appears in the title bar of the document.

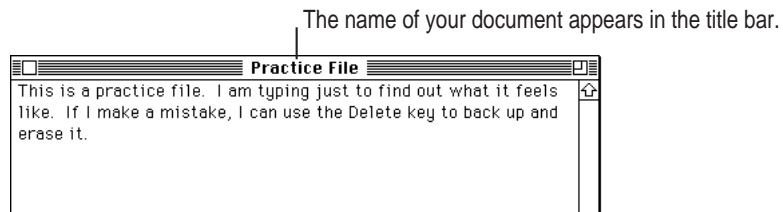

- 5** Open the File menu and choose Quit to quit the SimpleText program.

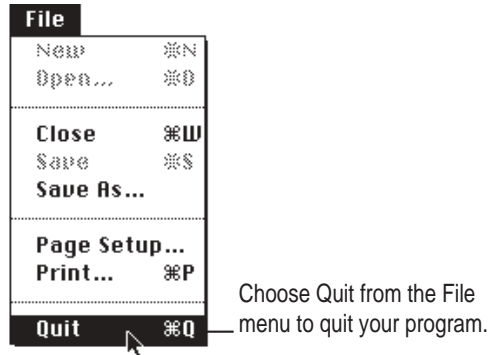

The SimpleText program closes, along with your document.

- 6** Check for the file you saved in the hard disk window.

You should see the icon for the document you saved in the hard disk window. If your Practice File icon doesn't appear, it may be in a hidden part of the window. You can scroll through the window to find the icon if you need to.

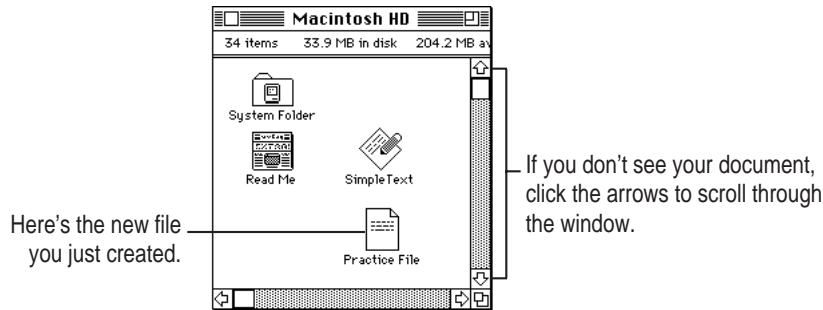

That's the end of the first exercise. You may want to take a break before you continue.

2: Storing your work inside a folder

You can organize your work on the Macintosh by creating folders and storing your documents inside of them.

1 Open the File menu and choose New Folder.

A folder icon named “untitled folder” appears in the active window on the desktop.



2 Without clicking anywhere, type “My Work” to name the folder.

Notice that the words “untitled folder” are highlighted and boxed. That means the name you type will replace these words.

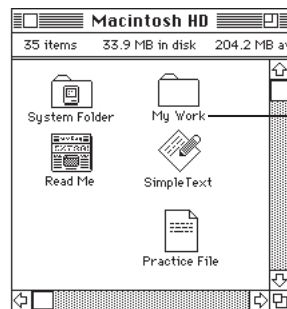

3 Drag the Practice File into the folder named “My Work.”

Move the pointer to the Practice File. Then press and hold down the button while you drag the Practice File to the folder named “My Work.” When the tip of the pointer is on the folder icon and the folder becomes highlighted, release the button.

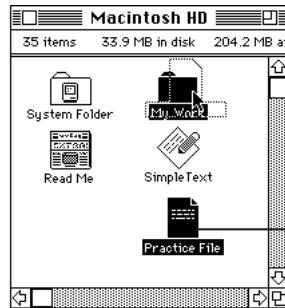

Move the pointer to this icon. Then press and hold down the button while you drag this icon to the folder named “My Work.”

4 Open the folder named “My Work.”

You open a folder the same way you open any icon: double-click it, or click it and choose Open from the File menu.

The “My Work” folder window opens, and you can see your Practice File.

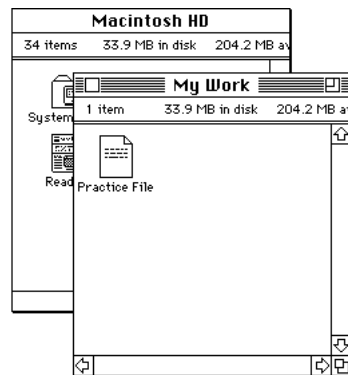

You have now completed the second practice exercise. You may want to take a break before continuing.

3: Throwing an item away

As you work, you will want to remove items you no longer need from the hard disk. You remove items by throwing them into the Trash. In this exercise, you will throw the Practice File into the Trash.

1 If the Macintosh HD window is not already open, open it by double-clicking the Macintosh HD icon.

2 If the folder named “My Work” is not already open, open it.

Note: If you can't see the Trash icon (which should be in the lower-right corner of your screen) move the windows so that the Trash icon is visible. To move a window, place the pointer in the window's title bar (the stripes at the top of the window), and drag the window.

3 Drag the Practice File to the Trash icon.

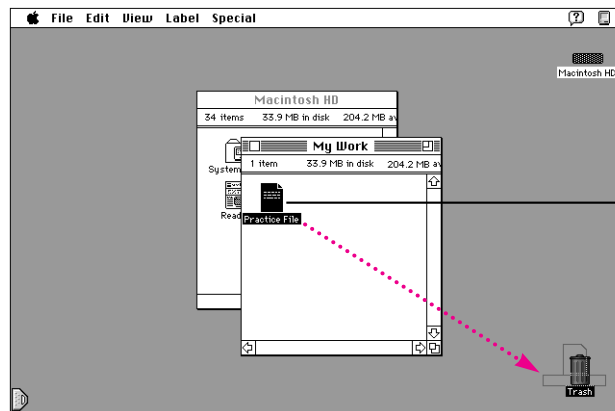

Place the pointer on the Practice File icon. Press and hold down the button as you move the pointer to the Trash icon.

When the tip of the pointer is on the Trash icon and the Trash icon becomes highlighted, release the button.

When you place an icon in the Trash, it is not immediately removed from your disk. The Trash icon bulges to show you that the Practice File is in the Trash, but still on your disk.

4 Open the Trash icon (by double-clicking it) to see your Practice File there.

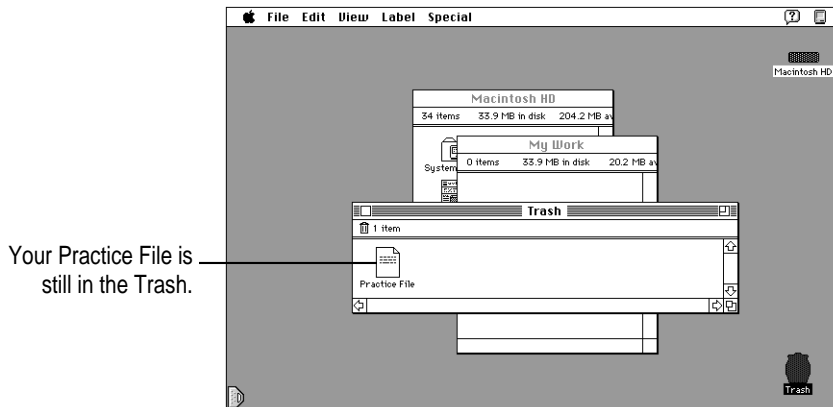

5 Open the Special menu and choose Empty Trash.

A dialog box appears. The computer displays a dialog box when it asks you to confirm an action. You must click OK or another button in the dialog box before you can take any other action.

6 Click OK.

The Trash is emptied and the Trash icon returns to normal.

The Empty Trash command permanently removes from your disk anything that is in the Trash. Always be sure that you know what you're removing before you choose Empty Trash.

Note: You can get an item back from the Trash by moving its icon back to your disk before you choose Empty Trash from the Special menu. After you choose Empty Trash, you can't recover items you've thrown away.

You have completed all of the practice exercises. Before you continue with your own work, you might want to skim Chapter 3, "Basic Skills," for a summary of basic skills that you'll need as you work.

What's next?

The best way to get experience working with your computer is to begin to do your own work. You may have already purchased application programs to work with. You'll need to install these on your hard disk. Be sure to read the manuals that came with your application programs for information on how to install them. (To install your programs, you'll need to know how to insert a floppy disk into the Duo Floppy Adapter. See Chapter 3, "Basic Skills," for instructions and Chapter 8 for information about the Duo Floppy Adapter.)

Clues on your screen

As you work, check the screen frequently for these important clues about where you are. If you are lost or if something unexpected happens, ask yourself these questions:

Is this the right program?

Check the menu bar. If it looks like this example, you are in the Finder. If any of these menu names are different or missing, you are inside another program. To get back to the Finder, click anywhere on the desktop pattern.

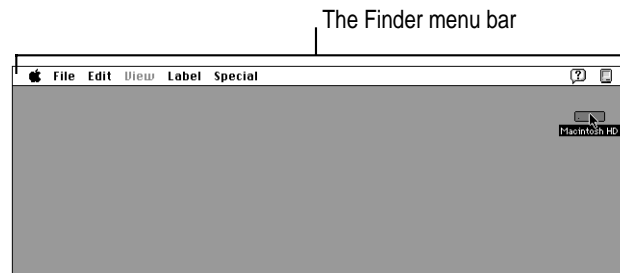

Is the correct window active?

Usually only the active window is affected when you type or use a menu. The active window has stripes in its title bar. To make a window active, click anywhere inside it.

Is the icon or text you want to work with selected?

Commands you choose in menus usually work only if an icon or some text is selected. Check the item you want to work with to make sure it's highlighted (which means it's selected).

Is it best to start over?

If you get stuck or lost as you practice on the computer, try one or more of the following remedies and then start the practice session over again:

- If an unwanted or confusing window is on your screen, click the Close box in the upper-left corner of the window to close it.
- If an unwanted window or box contains a Cancel button, click it.
- If the File menu contains the word Quit, choose it.
- If you're really stuck, restart your computer.

To restart, click the desktop (the background pattern on your screen), and then choose Restart from the Special menu. This turns the computer off and then back on. When you restart a computer, problems often clear up.

Refer to this chapter for information
on basic Macintosh skills

3

Basic Skills



This section provides information on the following basic skills:

- Working with icons
- Working with windows
- Working with documents
- Working with disks
- Organizing your desktop
- Working with menus
- Keyboard shortcuts in the Finder and in directory dialog boxes

Working with icons

An icon is a picture that represents something else.

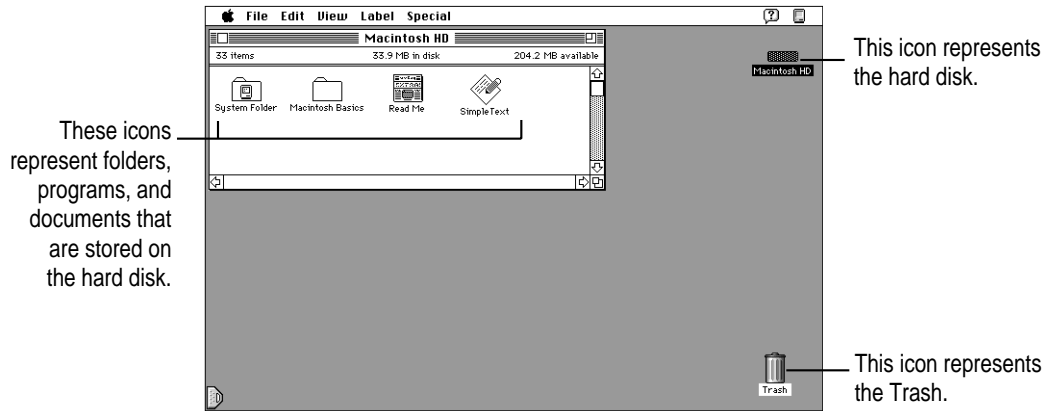

Selecting icons

To do this	Follow these steps
Select the icon	Click the item.
Deselect an icon	Click anywhere except the selected icon.
Select multiple icons	While holding down the Shift key, click each icon.
Deselect an icon in a group of selected icons	While holding down the Shift key, click the icon.
Select multiple icons that are near each other	<ol style="list-style-type: none">1. Place the pointer at one corner of a group of icons.2. Drag diagonally to select the icons, then release the button.
Select a list or partial list of icons	<ol style="list-style-type: none">1. Place the pointer to the left of the top icon or the bottom icon.2. Drag up or down the list, releasing the button when the items are selected.

Copying icons

To do this	Follow these steps
Copy an icon onto another disk	Drag the icon to the icon of the other disk or to an icon or window that belongs to that disk.
Copy an icon on the same disk	<ol style="list-style-type: none">1. Click the icon to select it.2. Choose Duplicate from the File menu, or press ⌘-D.3. If you wish, rename the new icon and drag it to a new location. You can also make a copy by holding down the Option key while you drag the icon to another folder or window.

Opening icons

To do this	Follow these steps
Open an icon (disk, folder, etc.)	<ol style="list-style-type: none">1. Click the icon.2. Choose the Open command from the File menu. Or double-click (click twice quickly) on the icon.

Moving icons

To do this	Follow these steps
Move an icon on a disk	Drag the item to the location you want.

Naming icons

To do this	Follow these steps
Select text in an icon's name	Click the icon name (not the icon itself).
Rename an icon	<ol style="list-style-type: none">1. Select the text under the icon.2. Type the new name.3. Press the Return key.

Removing items from the disk and retrieving them from the Trash

To do this	Follow these steps
Erase or remove an item from a disk	<ol style="list-style-type: none">1. Drag the icon to the Trash.2. Choose Empty Trash from the Special menu.
Retrieve an item from the Trash	<ol style="list-style-type: none">1. Open the Trash icon.2. Drag the icon out of the Trash (and into the disk or folder window where you want to store it). Or, choose Put Away from the File menu to return the icon to its original place on a disk.

Working with windows

A window opens when you double-click an icon. A window usually shows you what's inside an icon.

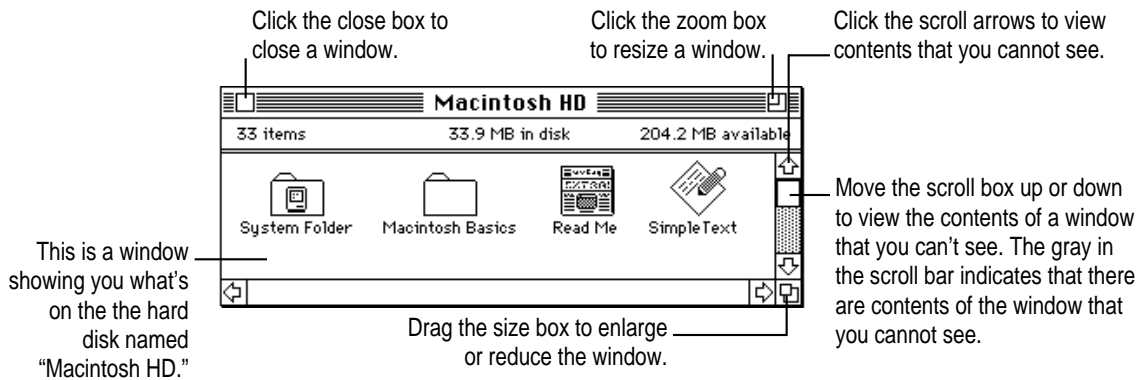

Viewing the contents of a window

To do this	Follow these steps
View the contents of a window by name, date, size, or kind	<ol style="list-style-type: none">1. Open the View menu.2. Choose the menu item that corresponds to the way you want to view the contents of the window.
View the contents of the window in outline form	<ol style="list-style-type: none">1. Choose any list view from the View menu (any view except the icon and small icon views).2. Click the triangle next to a folder name to display or hide the contents of the folder.

Making a window active

To do this	Follow these steps
Make a window active	Click anywhere inside the window or double-click its icon.

Opening higher level folders or disks

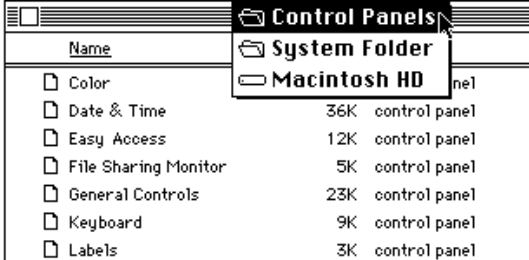

1 Hold down the ⌘ key as you press the title of the active window.

2 Drag to choose a higher-level folder (or disk) and then release the button.

Working with documents

Opening and closing a document

To do this	Follow these steps
Open a document	<ol style="list-style-type: none">1. Click the icon for the document.2. Choose the Open command from the File menu. Or double-click (click twice rapidly) on the icon.
Close a document	Choose Close from the File menu. Or click the close box of the document window.

Opening a document from within a program

To do this	Follow these steps
Open a document when you are working in an open program	<ol style="list-style-type: none">1. Choose Open from the File menu.2. Click the name of the document. (The illustration shows how to find a folder that you might not see.)3. Click the Open button.

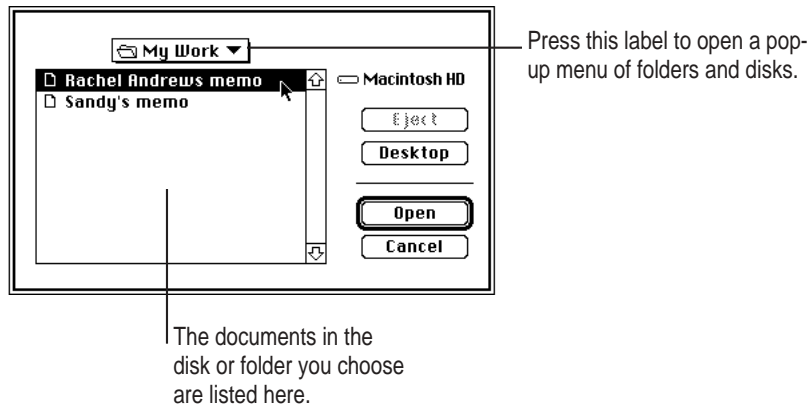

Saving and naming documents

To do this	Follow these steps
Save and name a document for the first time	<ol style="list-style-type: none">1. Choose the Save command from the File menu.2. Type a name for the document.3. Click the Save button.
Save the document under another name (Save as)	<ol style="list-style-type: none">1. Choose the Save As command from the File menu.2. Type a new name for the document.3. Click the Save button.

Choosing a folder when saving a document

To do this	Follow these steps
Save a document while working in a program	<ol style="list-style-type: none">1. Choose Save or Save As from the File menu.2. Click the name of the folder you want to save your document in. (The illustration shows how to find a folder that you might not see.)3. Click Open to open the folder.4. Name your document.5. Click the Save button to save the document inside the folder.

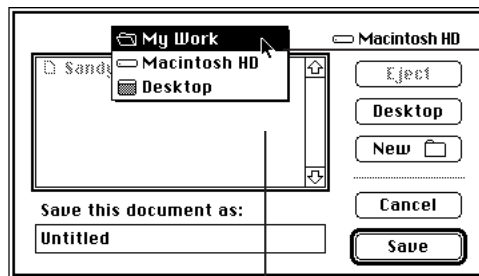

Press this label to open a pop-up menu of folders and disks.

The documents in the disk or folder you choose are listed here.

Working with disks

You can purchase a Duo Floppy Adapter that allows you to use floppy disks with your PowerBook Duo. See Chapter 8 for information on the Duo Floppy Adapter.

Preparing a new floppy disk for use

See “Using Disks” in the *Macintosh Reference* manual.

Ejecting a floppy disk

To do this	Follow these steps
Eject a floppy disk	Drag the disk's icon to the Trash.

Copying the contents of a disk

To do this	Follow these steps
Copy the entire contents of one floppy disk onto another floppy disk (with one disk drive)	<ol style="list-style-type: none">1. Insert the original floppy disk into the floppy disk drive.2. Drag the floppy disk icon to the hard disk icon. (The floppy disk contents appear in a folder on the hard disk.)3. Drag the floppy disk icon to the Trash.4. Insert the floppy disk that you want to copy to.5. Drag the icon of the newly created folder to the floppy disk icon.6. Drag the floppy disk icon to the Trash.
Copy an entire floppy disk onto a hard disk	<ol style="list-style-type: none">1. Drag the icon for the floppy disk to the icon for the hard disk. (The floppy disk contents appear in a folder on the hard disk.)
Copy items from a hard disk onto a floppy disk	<ol style="list-style-type: none">1. Select the items you want to copy.2. Drag the selected icons to the floppy disk's icon or window.
Copy items from a floppy disk onto a hard disk	<ol style="list-style-type: none">1. Select the items you want to copy.2. Drag the selected icons to the hard disk's icon or window.



Erasing the contents of a disk

To do this	Follow these steps
Erase the entire contents of a floppy disk	<ol style="list-style-type: none">1. Insert the disk you want to erase into a disk drive.2. Click the icon of the disk you want to erase.3. Choose Erase Disk from the Special menu.4. Respond to the messages on your screen by clicking the appropriate buttons.

Organizing your desktop

Creating a new folder

To do this	Follow these steps
Create a new folder	<ol style="list-style-type: none">1. Choose New Folder from the File menu.2. Type a name for the folder.3. Press the Return key.

Placing an icon inside a folder

To do this	Follow these steps
Place an icon inside a folder	<ol style="list-style-type: none">1. Drag the icon to the folder where you want to store it.2. Release the button when the folder icon becomes highlighted.

Working with pull-down menus

To choose an item from a menu:

- 1 Point to the menu.
- 2 Press to pull down the menu.
- 3 Drag to the item you want to choose.
- 4 Release the button when the command is highlighted.

This is the Help menu, which you use to display information about items on the screen.

Dimmed commands are not available.

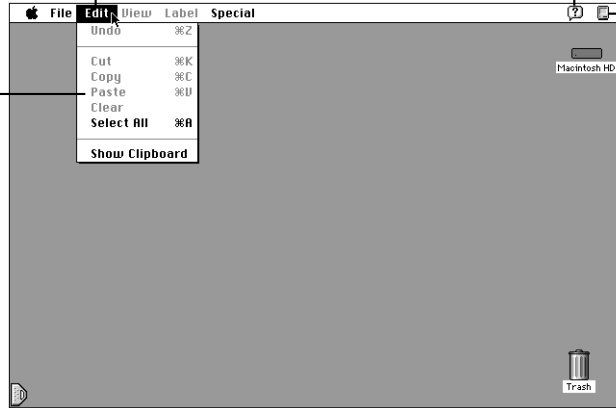

This is the Application menu, which you use to see which programs are open.

Keyboard shortcuts in the Finder and in directory dialog boxes

Key	Action
Up, Down, Left, or Right Arrow key	Selects the next item in the direction of the arrow
Tab key key (a, b, c...)	Selects the next item alphabetically (except in a directory dialog box and the Chooser)
Character	Selects the first item whose name begins with that character (or the character following closest to it in the alphabet)
⌘-Down Arrow	Opens the selected icon
⌘-Option-Down Arrow	Opens the selected icon and closes the current folder
⌘-Up Arrow	Opens the folder that contains the current folder
⌘-Option-Up Arrow	Opens the folder that contains the current folder and closes the current folder
Return or Enter	In a dialog box: the same as clicking the button with the bold outline In the Finder: selects the selected icon's name for editing or saves the edited name

Refer to this chapter for important health-related information and safety tips.

4

Health, Safety, and Maintenance Tips



Important care and safety instructions

For your own safety and that of your equipment, read and follow all the instructions in this section. Keep these instructions available for reference by you and others.

Warning

- Electrical equipment may be hazardous if misused. Operation of this product, or similar products, must always be supervised by an adult. Do not allow children access to the interior of any electrical product and do not permit them to handle any cables.
- Do not use the computer in or near water.
- Do not use cables that are frayed or otherwise damaged. Hold a cable by its connector (the plug, not the cord) when connecting or disconnecting it.
- Always handle batteries carefully.
- Do not drop, puncture, mutilate, or burn the computer or battery.
- Recharge batteries only as described in this manual and only in ventilated areas.
- Transport batteries either inside the computer or in the protective case provided with each battery. Do not transport unprotected batteries.
- Do not short-circuit the battery terminals (that is, do not allow a metal object such as a paper clip or key chain to touch the terminals). Doing so may cause an explosion or a fire.

Caution

- If you have a problem with your computer and nothing in the computer manuals solves the problem, take the computer to your Apple-authorized dealer or service provider. Attempting to repair the computer yourself may void the limited warranty.
- Do not move the computer when you can hear its hard disk spinning. When you put the computer to sleep, wait until the screen is blank before moving the computer.
- Use only the power adapter supplied with your computer. Adapters designed for other electronic devices may look similar, but they may not work with your equipment and may damage the computer.
- Never force a connector into a port. Make sure that the connector matches the port and that it's right side up. If the connector and port do not join easily, they do not match.
- Do not use the computer in wet or dusty environments.
- Keep dirt and liquids away from the ports on the back panel, the keyboard, and the trackball. If you spill any food or liquid onto the computer, shut it down immediately and unplug it before cleaning up the spill. Depending on what you spilled and how much got into the computer, you may have to bring the computer to an Apple-authorized service provider for cleaning.
- Do not touch the screen with any sharp or pointed objects.
- Use only the battery supplied with your computer. Batteries designed for other portable computers may look similar, but they may not work with your computer and may damage it.
- When recharging the battery, use only the power adapter supplied with your computer. Adapters designed for other electronic devices may not work with your equipment and may damage the computer or the recharger.
- Do not leave batteries in hot locations (such as the trunk of a car).

Important

- If the computer has been in a cold place for several hours, let it warm up to room temperature before you use it.
- Use the computer only in environments where the temperature range is between 50°F/10°C and 104°F/40°C.
- Do not expose the computer to very low (less than –13°F/–25°C) or very high (more than 140°F/60°C) temperatures.
- Clean the computer's outside surfaces with a damp (not wet) cloth. Clean the screen with soft, lint-free paper or cloth and a mild glass cleaner. Do not spray the glass cleaner directly onto the screen.

Caring for batteries

- Always handle batteries carefully.
- Do not short-circuit the battery terminals (that is, do not touch both terminals with a metal object). Doing so may cause an explosion or a fire.
- Do not drop, puncture, disassemble, mutilate, or incinerate the battery.
- Recharge batteries only as described in this manual and only in ventilated areas.
- Do not leave batteries in hot locations (such as the trunk of a car) for more than a day or two.
- Do not leave a battery in your computer for longer than a week without plugging in the power adapter.
- Do not leave a battery in storage for longer than 6 months without recharging it.
- Take dead batteries to an Apple-authorized service provider for recycling or proper disposal. The batteries contain hazardous chemicals and should not be thrown out with household or office trash.

Health-related information about computer use

Muscle soreness, eye fatigue, and other discomforts and injuries sometimes associated with using computers can occur from performing any number of activities. In fact, misuse of the same muscles during multiple activities can create a problem that might not otherwise exist. For example, if you engage in nonwork activities that involve repetitive stress on the wrist—such as bicycling—and also use your computer’s keyboard improperly, you may increase your likelihood of developing wrist problems. Some individuals are at greater risk of developing these problems because of their health, physiology, lifestyle, and general exposure to stress. Work organization and conditions, such as workstation setup and lighting, also play a part in your overall health and comfort. Preventing health problems is a multifaceted task that requires careful attention to the way you use your body every hour of every day.

The most common health effects associated with using a computer are musculoskeletal discomfort and eye fatigue. We’ll discuss each area of concern below.

Musculoskeletal discomfort

As with any activity that involves sitting for long periods of time, using a computer can make your muscles sore and stiff. To minimize these effects, set up your work environment carefully, using the guidelines that follow, and take frequent breaks to rest tired muscles. To make working with your computer more comfortable, allow enough space in your work area so that you can change position frequently and maintain a relaxed posture.

Another type of musculoskeletal concern is repetitive stress injuries (RSIs), also known as cumulative trauma disorders (CTDs). These problems can occur when a certain muscle or tendon is repeatedly overused and forced into an unnatural position. The exact causes of RSIs are not totally understood, but in addition to awkward posture, such factors as the amount of repetition, the force used in the activity, the individual’s physiology, workplace stress level, and lifestyle may affect the likelihood of experiencing an RSI.

RSIs did not suddenly arise when computers were invented; tennis elbow and writer's cramp, for example, are two RSIs that have been with us for a long time. Although less common than other RSIs, one serious RSI discussed more often today is a wrist problem called carpal tunnel syndrome, which may be aggravated by improper use of computer keyboards. This nerve disorder results from excessive pressure on the median nerve as it passes through the wrist to the hand.

This section offers advice on setting up your work area to enhance your comfort while you use your computer. Since the effects of repetitive movements associated with using a computer can be compounded by those of other work and leisure activities to produce or aggravate physical problems, proper use of your computer system must be considered as just one element of a healthy lifestyle.

No one, of course, can guarantee that you won't have problems even when you follow the most expert advice on using computer equipment. You should always check with a qualified health specialist if muscle, joint, or eye problems occur.

Eye fatigue

Eye fatigue can occur whenever the eyes are focused on a nearby object for a long time. This problem occurs because the eye muscles must work harder to view an object that's closer than about 20 feet (6 meters). Improper lighting can hasten the development of eye fatigue. Although eye fatigue is annoying, there's no evidence that it leads to permanent damage.

Whenever you're engaged in an activity that involves close-up work—such as reading a magazine, doing craft work, or using a computer—be sure to have sufficient glare-free lighting and give your eyes frequent rest breaks by looking up and focusing on distant objects. Remember to have your eyes examined regularly.

To prevent discomfort and eye fatigue:

- Arrange your work space so that the furniture is properly adjusted for you and doesn't contribute to an awkward working posture.
- Take frequent short breaks to give your muscles and eyes a chance to rest.

Arranging your work area and equipment

The suggestions in this section can help you work more comfortably with your computer.

Chair

- An adjustable chair that provides firm, comfortable support is best. Adjust the height of the chair so your thighs are horizontal and your feet flat on the floor.

The back of the chair should support your lower back (lumbar region). Follow the manufacturer's instructions for adjusting the backrest to fit your body properly.

Keyboard and trackball

- When you use the keyboard and trackball, your shoulders should be relaxed. Your upper arm and forearm should form an approximate right angle, with your wrist and hand in roughly a straight line.

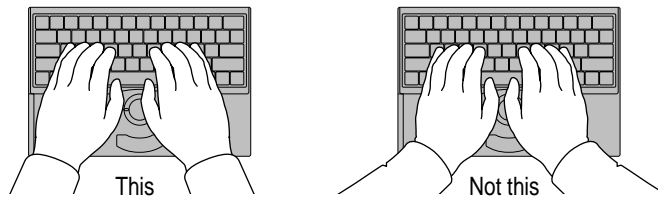

- You may have to raise your chair so your forearms and hands are at the proper angle to the keyboard. If this makes it impossible to rest your feet flat on the floor, you can use a footrest with adjustable height and tilt to make up for any gap between the floor and your feet. Or you may lower the desktop to eliminate the need for a footrest. Another option is to use a desk with a keyboard tray that's lower than the regular work surface.

- Use a light touch when typing or using the trackball and keep your hands and fingers relaxed. When using the trackball or keyboard, avoid rolling your thumbs under your palms.

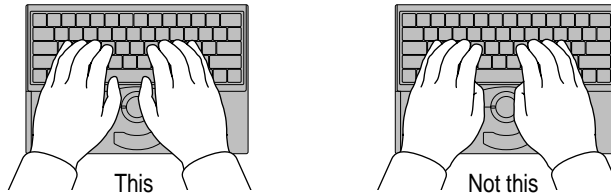

Some computer users may develop discomfort in their hands, wrists, or arms after intensive work without breaks. If you begin to develop chronic pain or discomfort in your hands, wrists or arms, consult a qualified health specialist.

- Change hand positions often to avoid fatigue.
- If you prefer, you can adjust the angle of the keyboard by lowering the legs until they snap into position.

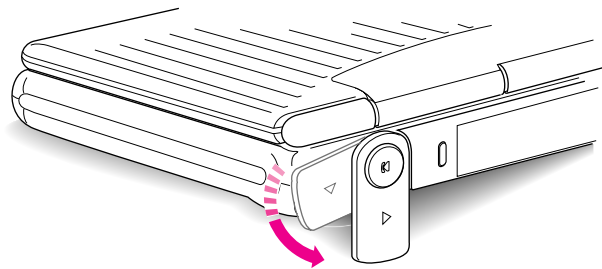

The back of the keyboard is slightly elevated when the legs are in use. Otherwise, the keyboard is level.

Mouse

- If you use a mouse, position the mouse at the same height as your keyboard. Allow adequate space to use the mouse comfortably.

Built-in display

- Adjust the angle of the display to minimize glare and reflections from overhead lights and windows.
- If your display screen has manual brightness and contrast controls, you may need to adjust the brightness and contrast of the screen when you take the computer from one work location to another, or if the lighting in your work area changes.

External monitor

If you use an external monitor, this suggestion may be helpful.

- If possible, arrange the monitor so the top of the screen is slightly below your eye level when you're sitting at the keyboard. The best distance from your eyes to the screen is up to you, although most people seem to prefer 18 to 28 inches (45 to 70 cm).

Avoiding fatigue

- Change your seated position, stand up, or stretch whenever you start to feel tired. Frequent short breaks are helpful in reducing fatigue.
- Allow adequate workspace so that you can work comfortably. Place papers or other items so you can view them easily while using your computer. A document stand may make reading papers more comfortable.
- Eye muscles must work harder to focus on nearby objects. Occasionally focus your eyes on a distant object, and blink often while you work.
- Clean your screen regularly. Keeping the screen clean helps reduce unwanted reflections.

What about electromagnetic emissions?

There has been recent public discussion of the possible health effects of prolonged exposure to extremely low frequency (ELF) and very low frequency (VLF) electromagnetic fields. Such fields are associated with electromagnetic sources such as television sets, electrical wiring, and some household appliances—as well as computer monitors.

Apple has reviewed scientific reports and sought the counsel of government regulatory agencies and respected health organizations. Based on the prevailing evidence and opinions, Apple believes that the electric and magnetic fields produced by computer monitors do not pose a health risk.

In response to those customers who wish to reduce their exposure to electromagnetic fields, Apple has lowered the emission levels of our products. We are also actively encouraging further scientific research so we can continue to promote the health and safety of our customers and employees.

This chapter describes working with the Control Strip, the line of modules at the bottom of your screen.

5

The Control Strip



What is the Control Strip?

When you first turn on your PowerBook, a line of small pictures appears in the lower left of the screen. This is called the *Control Strip*. Each picture in the Control Strip is called a *module*.

The Control Strip is a quick and easy way to monitor and update your PowerBook's power management options. For instance, you can monitor the battery charge level and the amount of work time left on your battery. You can also adjust such options as File Sharing and sound volume.

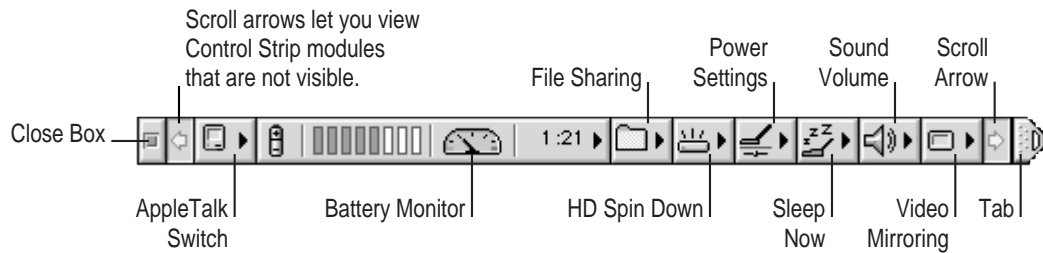

The Control Strip may look slightly different depending on the options on your PowerBook.

To get a description of each module in the Control Strip, pull down the Help Menu, choose Show Balloons and point to the modules one at a time.

How does the Control Strip differ from control panels?

Many features in the Control Strip work the same way as control panels. For the most part, however, control panels offer more options. The Control Strip gives you an easy way to access the features you use most often. You can still use the control panels anytime to fine-tune your settings.

Closing, opening, and resizing the Control Strip

Closing the Control Strip

The Control Strip appears on the desktop until you close it. You can close the Control Strip one of two ways:



1 Click the tab at the end of the Control Strip.



2 Click the close box at the beginning of the Control Strip.

The Control Strip appears on top of application programs. When you close the Control Strip, only the tab appears along the edge of the screen.

Opening the Control Strip

To open the Control Strip:

- Click once on the tab.



The Control Strip opens.

Resizing the Control Strip

You can shorten or lengthen the Control Strip to display fewer or more modules.

- Click and drag the tab.



The Control Strip shortens or lengthens as you drag the tab. If you shorten the Control Strip and can no longer see all the modules, use the scroll arrows.

Hiding the Control Strip

If you want to hide the Control Strip so it does not appear at all on the desktop:

- 1 Choose Control Panels from the Apple () menu, and open the Control Strip control panel.



Control Strip

- 2 Click Hide Control Strip.

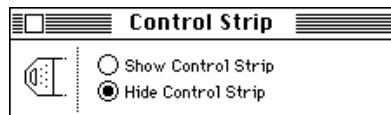

The Control Strip automatically disappears from the screen.

Click Show Control Strip in the Control Strip control panel when you want the Control Strip to reappear.

Moving the Control Strip

You can drag the Control Strip to the right or left edge of your PowerBook's screen or any monitor your PowerBook is connected to. To reposition the Control Strip:

- 1 Hold down the Option key and drag the Control Strip by its tab.**

An outline of the Control Strip shows where the Control Strip will move to.

- 2 Release the Option key and trackball button.**

The Control Strip appears in its new position, and remains there until you move it again.

Rearranging the modules in the Control Strip

You can customize the order of the modules in the Control Strip. To rearrange the modules:

- 1 Hold down the Option key and drag each module you want to move.**
- 2 Release the Option key and trackball button.**

The module you are moving snaps into place. The modules stay in the new order until you rearrange them.

Using the Control Strip

Monitoring the charge level of the battery

Your computer draws power from a rechargeable battery. The Battery Monitor module in the Control Strip lets you easily monitor the battery charge level. The work time you get from your battery depends on how often you use the hard disk, how bright the screen is, and other factors.

The Battery Monitor has four parts:

- battery icon
- battery charge level

- battery consumption rate
- estimated work time remaining

The battery icon tells you whether a battery is installed, is being used to power the computer, is being recharged, or is fully charged.

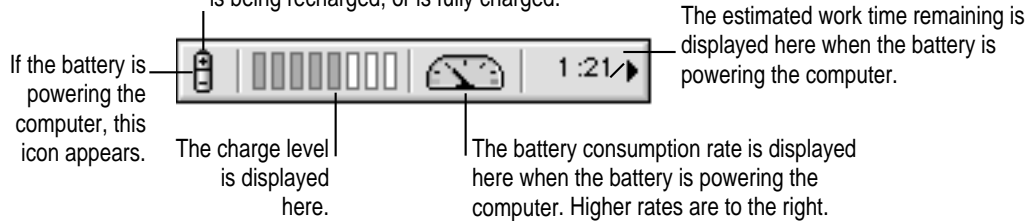

The battery charge level, battery consumption rate, and estimated work time remaining change depending on the software, hardware, and power saving features you use.

The battery icon changes depending on whether the battery is being charged, is fully charged, or is powering the computer. Notice that the battery consumption rate and the work time left are displayed only when the computer is being powered by the battery.

If the power adapter is plugged in and charging the battery, this icon appears.

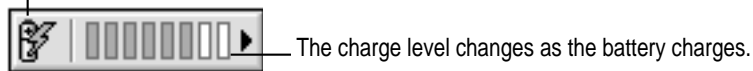

If the power adapter is plugged in and the battery is fully charged, this icon appears.



If the power adapter is plugged in and the battery is not in the computer, this icon appears.



Customizing the Battery Monitor module

You can customize the Battery Monitor module to display only the features you want. Follow these steps:

- 1 Click the **Battery Monitor module in the Control Strip.**

The following pop-up menu appears.



- 2 Choose the feature you want to hide or show.

You cannot hide the battery icon.

Changing the battery conservation settings

You can control your computer's power consumption using the power conservation settings in the Power Settings module. You can also open the PowerBook control panel from the Power Settings module.

- 1 Click the **Power Settings module in the Control Strip.**

A pop-up menu appears.

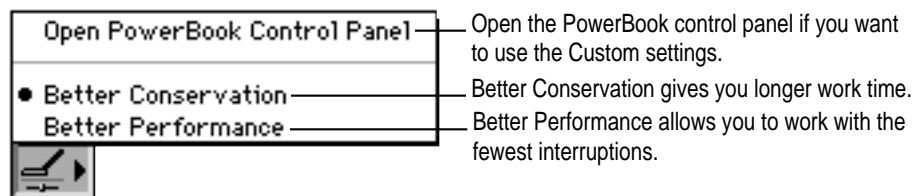

- 2 Choose the feature you want from the pop-up menu.

The battery conservation settings shown are identical to those shown in the Easy View area of the PowerBook control panel. For help with the PowerBook control panel, see "Adjusting the Battery Conservation Settings" in the "Maximizing Work Time" section of Chapter 6.

Spinning down the hard disk

The hard disk is one of the main consumers of battery power. To extend work time while you are using your battery, it is a good idea to turn off the hard disk when you are not using it. This is called “spinning down” the hard disk.

To spin down the hard disk:

- 1 **Click the HD Spin Down module in the Control Strip.**

A pop-up menu appears.

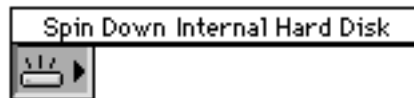

- 2 **Choose Spin Down Internal Hard Disk.**

The icon shows that the hard disk is off.



The hard disk automatically turns itself back on when the computer needs it.

Putting the computer to sleep

Putting your PowerBook to sleep when you take a work break, even for a few minutes, can give you more work time from your battery. To put your PowerBook to sleep from the Control Strip:

- 1 **Click the Sleep Now module in the Control Strip.**

A pop-up menu appears:

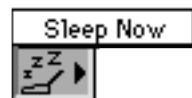

- 2 **Choose Sleep Now.**

Note that if you use a PowerBook Duo 280c, a flashing green light appears in the upper right corner of the computer's display.

Your PowerBook goes to sleep. To wake the computer from sleep, press any key on the keyboard (except Caps Lock). There are three other ways you put your PowerBook to sleep:

- close the computer's display
- choose the Sleep command from the Special menu in the Finder
- hold down the ⌘ (Command) and Shift keys while you press and release the zero (0) key.

For more information on sleep, see Chapters 1 and 6.

Changing the file sharing options

The icon of the File Sharing module tells you whether file sharing is on and whether users are connected.



File Sharing is turned off.



File Sharing is turned on and no users are connected.



File Sharing is turned on and at least one user is connected.

To change the file sharing option or open the File Sharing Setup control panel:

- 1** Click the File Sharing module in the Control Strip.

A pop-up menu appears:



- 2** Choose the file sharing option you want from the pop-up menu.

For more information on file sharing and working on a network, see the *Macintosh Reference* book.

Changing the sound settings

Your computer's sound volume can be changed from the Control Strip:

- 1 **Click the Sound Volume module in the Control Strip.**

A pop-up menu appears:

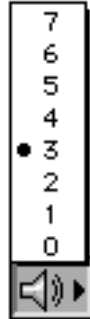

- 2 **Choose the volume setting you want from the pop-up menu.**

For more information on sound, see the *Macintosh Reference* book.

Turning an AppleTalk connection on and off

The icon for the AppleTalk Switch module shows if AppleTalk is on or off.



Turning AppleTalk off can save you battery power. You can turn AppleTalk on and off from the Control Strip.

- 1 **Click the AppleTalk Switch module in the Control Strip.**

A pop-up menu appears:

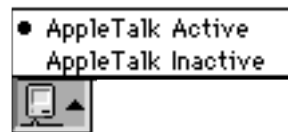

2 Choose the feature you want from the pop-up menu.

For more information on AppleTalk and working on a network, see the *Macintosh Reference* book.

Using video mirroring

If your PowerBook is connected to an external monitor you can display the same image on the internal display and an external monitor. This feature is called “video mirroring.”

When an external monitor is connected to your PowerBook, the Video Mirroring module appears in the Control Strip. The icon shows whether video mirroring is on or off.

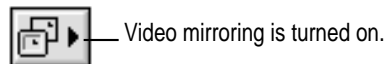
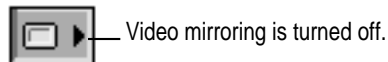

You can turn video mirroring on and off from the Control Strip.

1 Click the Video Mirroring module in the Control Strip.

A pop-up menu appears:



2 Choose the feature you want from the pop-up menu.

The Video Mirroring module offers exactly the same features as the PowerBook Display control panel. For information of using the PowerBook Display control panel, see “Using Other Equipment With Your Duo System” in Chapter 8.

Read this chapter to learn how you can maximize your PowerBook's battery life.

6

Power Management



Power sources

Your computer can draw its operating power from two different sources:

- **Main battery** Your computer's main power source is a nickel-metal-hydride battery. The battery provides power for about 2–4 hours of work time (depending on the battery conservation features you choose).
- **AC power** You can run your computer from any standard electrical outlet by plugging in the power adapter.

Your computer also has a backup battery that maintains the contents of RAM while you replace the main battery. The backup battery does not provide enough power to run the computer.

These power sources are described in more detail in the following sections.

Monitoring the battery charge level

There are two ways you can monitor the charge level of your battery:

- **Use the Battery Monitor module in the Control Strip.** See Chapter 5 for instructions.
- **Use the Battery desk accessory.** See the next section for instructions.

Using the Battery desk accessory

The main battery provides power for about 2–4 hours of work (the exact time depends on how often you use the hard disk, how bright the screen is, and other factors). Use the Battery Monitor module in the Control Strip or the Battery desk accessory to monitor the battery charge level so you can recharge it when necessary. The Battery Monitor module is explained in Chapter 5.

To use the Battery desk accessory, follow these steps:

- 1 Choose Battery from the Apple menu to open the Battery desk accessory.

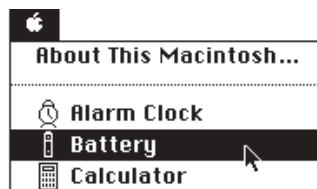

The Battery desk accessory appears.



The line of rectangles indicates the charge level. You can see the level decrease while the battery is in use, and increase while the battery is recharging in the computer.

A lightning bolt icon appears when the power adapter is plugged in and the battery is recharging in the computer. The lightning bolt icon disappears when the battery is fully charged.

- 2 If you want to put the PowerBook to sleep, click the lever to the right of the battery gauge and then click the sleep button.

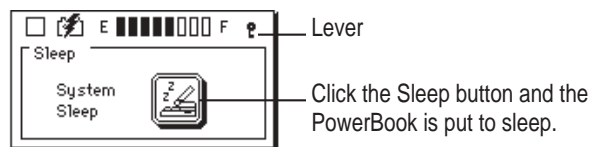

You can also put the computer to sleep by choosing the Sleep command from the Special menu or the Sleep Now module in the Control Strip.

Responding to low-power messages

When the battery runs low, the computer displays a series of low-power messages. The work time remaining after you see the first message varies depending on how you are using the computer. It's a good idea to act promptly.

What you should do

When you see a low-power message, you should do one of the following:

- **Plug in the power adapter.**
- **Save your work and put the computer to sleep.**

What you should know

The first low-power message is a reminder that the battery will soon run out. When this message appears, the screen brightness dims automatically to save power.

If you continue to work without plugging in the power adapter or changing the battery, the computer displays a second low-power message.

The second message is followed by a third and final message indicating that the computer is about to put itself to sleep. Within a few seconds, the computer goes to sleep automatically to protect the contents of RAM. All activities are interrupted. It's a good idea to save your work when you see the first two low-power messages to make sure you don't lose information.

If you continue working until the computer goes to sleep automatically, you can wake it again as soon as you plug in the power adapter or replace the battery with a fully charged battery.

If you can't plug in the power adapter, the contents of RAM are retained in sleep for about a day. If you recharge or change the battery within a day, you should be able to wake the computer and resume work where you left off.

IMPORTANT Recharge a depleted battery as soon as possible. Leaving a depleted battery in the computer for more than several months, or in a hot location (such as the trunk of a car) for longer than two weeks, may damage the battery so that it can't be recharged. If this happens, you need to replace the battery.

Recharging the battery

There are two ways to recharge a battery:

- Plug in the power adapter to recharge the battery without removing it from the computer.
- Remove the battery and recharge it in the (optional) recharger.

Recharge a battery shortly before you plan to use it. The battery does not retain its charge in long-term storage.

Recharging in the computer

Plug in the power adapter as shown.

WARNING Use only the power adapter that came with your computer. Adapters for other electronic devices (including other portable computers) may look similar, but they may damage your computer.

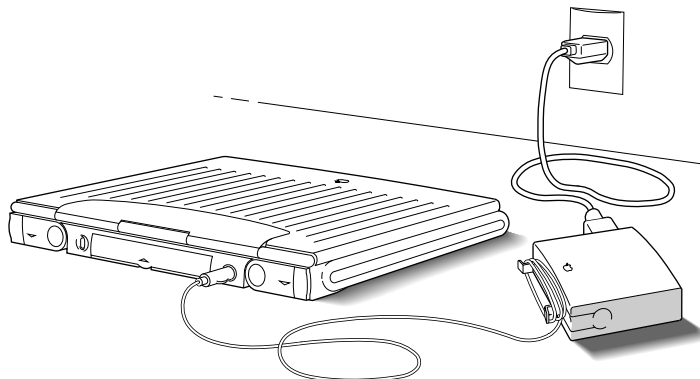

You can continue to use the computer while the battery is recharging. Using the computer does not affect the amount of time it takes the battery to recharge.

If you recharge a fully depleted battery with the computer in sleep or shut down, it usually takes a little over 2 hours to bring the battery charge to 100 percent, but the time may vary depending on the PowerBook you have and the battery you are recharging.

Recharging in a recharger

A battery recharger and additional batteries are available for purchase. If you purchase a recharger and an extra battery, you can charge one battery while you use the other, so you always have a fully charged battery on hand.

The recharger can accommodate two batteries, and charges them one battery at a time. You can put batteries in or take them out at different times.

The recharger must be plugged into an electrical outlet to charge a battery. You can plug it in using the power adapter that came with your computer, or you can purchase an additional (identical) power adapter from your Apple-authorized dealer.

WARNING Use only the power adapter that came with your computer with the recharger. Using other types of power adapters may damage the recharger, the power adapter, or both.

To recharge a battery, follow these steps:

- 1 Place the recharger on a level surface.**
- 2 Connect the recharger and the power adapter as shown in the illustration.**

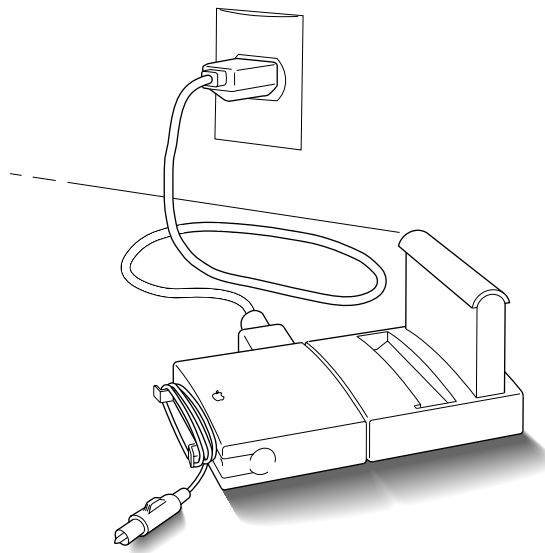

3 Place the battery in the recharger as shown.

Recharging begins immediately. You can remove a battery from the recharger at any time. Remember, if you are charging two batteries, they charge one at a time. It takes about two hours to charge each battery.

IMPORTANT To preserve a battery's charge, don't leave it in the recharger if the power adapter is not plugged into an electrical outlet.

The lights on the recharger indicate the following:

- **No light** Either the recharger is not plugged in, the other battery is being charged (if you have two batteries in the recharger), or the battery is defective. (If the light goes off during recharging, there is a problem with the battery.)
- **Yellow** The battery is charging.
- **Green** The battery is fully charged.
- **Red** The charge does not recognize the type of battery inserted. If you are charging a replacement battery, follow the instructions that came with it.

Recharging in both the computer and a recharger

You can use a single power adapter to run the PowerBook Duo and the battery recharger at the same time.

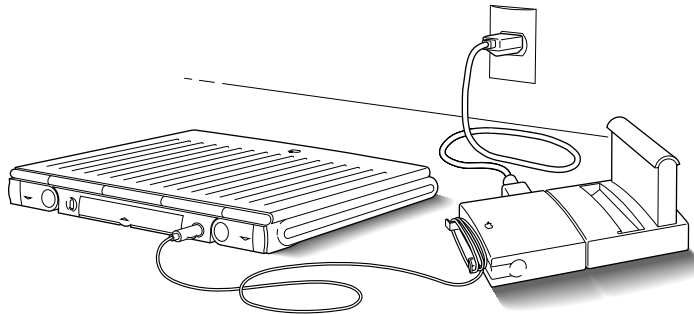

If the PowerBook is on and contains a battery that is not fully charged, the computer charges the internal battery first. The external battery does not begin charging until the internal battery is fully charged. If you are still using the computer at that point, it takes a little over 2 hours for a fully depleted external battery to charge.

If the PowerBook is in sleep or is shut down, internal and external batteries charge simultaneously. If both batteries are fully depleted, it takes about 4½ hours to charge both. If the internal battery is fully charged or absent, the external battery takes a little over 2 hours to charge.

Removing or replacing the battery

- *If the power adapter is plugged in, you can use the computer indefinitely without a battery.*
- *If the power adapter is not plugged in, the backup batteries in your computer protect open programs and documents for about 4 minutes, allowing you to remove the depleted battery and replace it with a charged one. (The backup batteries maintain other kinds of information, including control panel settings such as the clock time, for up to two weeks after the main battery is discharged or removed.)*

To remove or replace the main battery, follow these steps:

- 1 Save your work, and then choose Sleep from the Special menu.**

You can choose Shut Down instead of Sleep if you feel more comfortable working without the 4-minute time limit.

- 2 Close the display.**

- 3 Open the battery door by pressing the small button and sliding the door in the direction indicated by the arrow.**

The door is physically attached to the battery.

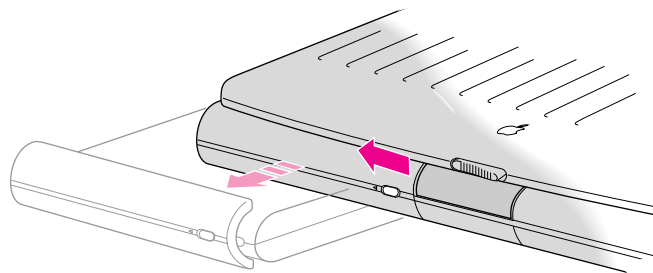

- 4 Carefully pull the battery out of its compartment.**

- 5 **If you are inserting another battery, slide it into the battery compartment.**

Replacement batteries come with a door attached.

- 6 **Close the battery door by pushing it back into place.**

IMPORTANT Check to make sure the battery is properly inserted (the battery should be aligned with the computer and the battery door completely closed). If a battery is not inserted correctly, you may have performance problems.

- 7 **If possible, plug in the power adapter in case the battery is not fully charged.**

WARNING Damaged nickel-metal-hydride batteries may leak small amounts of sodium hydroxide. This substance can cause severe burns to the skin and eyes. If you touch a damaged battery, immediately rinse your hands and any other affected areas with water for at least five minutes. Do not use soap.

Disposing of dead batteries

IMPORTANT Nickel-metal-hydride batteries contain metals that can be reclaimed and reused. Instead of throwing away dead batteries, please dispose of them as described here.

In the United States: Return dead batteries to your Apple-authorized service provider, who will make sure they are included in Apple's battery recycling program.

Elsewhere: Many countries have government- or Apple-sponsored collection and/or recycling programs for dead batteries. Dispose of dead batteries in accordance with the mandatory or voluntary battery collection schemes in your country. Contact your Apple-authorized service provider for information about the recommended battery disposal procedures in your location. If there is no government- or Apple-sponsored return program, you can dispose of the batteries with your regular trash, taking care not to break them open or incinerate them.

Replacing the backup battery

In addition to its main battery, your computer has a small backup battery that maintains the contents of RAM while you replace the main battery.

The backup battery usually lasts for several years. You may need to have it replaced if you notice that some of your system settings changed after you removed or replaced the main battery. (You may notice, for example, that the clock time is different.) By replacing the backup battery you can preserve the contents of RAM the next time you change the main battery.

Your computer's backup battery must be replaced by an Apple-authorized service provider.

Reconditioning the battery

To maximize battery life, you should recondition the battery once every 30 days.

If you own a PowerBook Duo 280 or 280c

If you have a PowerBook Duo 280 or 280c, you can extend your battery's life by reconditioning your battery once every 30 days using the Battery Reconditioning program, which is on the system software disk labeled *Disk Tools*. You may want to keep a copy of the Battery Reconditioning program on your hard disk so it is more convenient to use every 30 days.

IMPORTANT It takes 2 hours to run the Battery Reconditioning program and about 2 hours to fully charge your battery in your PowerBook. During the time you are reconditioning your battery (and recharging it if you don't have a recharger), you cannot use your PowerBook. Plan to recondition your battery when you won't need your PowerBook for at least 4 hours.

To recondition a battery, follow these steps:

- 1 Plug in your PowerBook using your AC power adapter.**

If you have already copied the Battery Reconditioning program on your hard disk, skip step 2 and do step 3 next.

- 2 Insert *Disk Tools* in the floppy disk drive and turn on your PowerBook.**

- 3 Locate the Battery Reconditioning icon and open it.



Battery Reconditioning

A message appears on the screen describing battery reconditioning. If you don't have your PowerBook plugged in, a message appears telling you to plug it in.

- 4 Read the message on the screen and click OK.

The following appears:

The type of battery in your computer appears here.

The date you last reconditioned your battery appears here. A warning appears below the date if it has been less than 30 days since the last recondition.

- 5 Click Recondition if it has been more than 30 days since the last time you reconditioned the battery.

If 30 days have not passed since the last time you reconditioned, the following appears on the screen:

Records indicate that this battery was reconditioned less than a month ago. You should recondition your battery no more than once a month.

Click Quit to exit the Battery Reconditioning program.

If 30 days have passed since you last reconditioned, this message appears:



Remember that it takes 2 hours to recondition the battery and 2 hours to fully charge the battery. Make sure you do not need to use your PowerBook for 4 hours.

6 Click OK.

While the reconditioning cycle is taking place, the following icon appears on the screen:



Command-Period to quit.

You can quit the Battery Reconditioning program at any time by pressing the period key and the ⌘ (Command) key at the same time. Also, if you unplug your PowerBook during reconditioning, you quit the reconditioning program. Your battery is not reconditioned if you quit in the middle of the reconditioning cycle.

When the reconditioning is complete, the following appears on the screen for one minute:

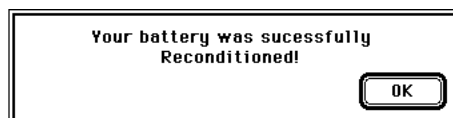

7 Click OK.

The battery is reconditioned. Allow time to recharge the battery by leaving the PowerBook plugged in for 2 hours. Follow these steps again in 30 days to maximize the life of the battery.

If you own a PowerBook Duo 230

If you own a PowerBook Duo 230 and want to recondition your battery, you must fully drain and then fully recharge the battery. Follow these steps:

- 1 Use the computer as you normally would, but ignore the low-power messages that appear on the screen.**

Make sure to save your work when you see the low-power messages.

- 2 Allow the computer to go to sleep automatically after the third low-power message.**

- 3 Recharge the battery completely before using that battery again.**

See “Recharging the Battery” earlier in this chapter for help.

Maximizing work time

Your PowerBook’s battery can provide between 2 to 4 hours of work time before you need to recharge. The actual work time available depends on what equipment and power-saving features you’re using.

Ways to conserve battery power

Notice the battery consumption rate that is displayed in the Battery Monitor module of the Control Strip when you are running your PowerBook off the battery. When it points to the left, you are conserving battery power and will have more work time from your battery. To conserve battery power, follow these tips:

- If you’re working near an electrical outlet, plug in the power adapter.
- If you aren’t using the computer, put it to sleep and plug in the power adapter.
- Turn down the screen brightness (☼) whenever possible. At its brightest level, the screen consumes about a third of the power your computer is using.
- Keep virtual memory turned off in the Memory control panel.
- If your computer has 8 MB of memory or more, you can use a RAM disk as your startup disk to minimize hard disk use.

- Quit any modem-related program as soon as you are finished using it. As long as the program is open, your modem is consuming power even if you are not using the modem.
- If you have a Duo 280 or 280c, use the Battery Reconditioning program every 30 days.
- Keep screen dimming on in the PowerBook control panel. The lower settings dim your screen automatically if you haven't used the computer for a few minutes.
- Set the Battery Conservation slider in the PowerBook control panel at Better Conservation. The rest of this section describes these settings in detail.

Adjusting the Battery Conservation settings

The Battery Conservation section of the PowerBook control panel gives you several ways to control your computer's power consumption.

The easiest approach

- 1 Choose Control Panels from the Apple () menu, and open the PowerBook control panel. (Or use the Power Settings module in the Control Strip to open the PowerBook control panel.)



PowerBook

The PowerBook control panel opens in Easy View. You can also choose Custom View for more detailed options. See “Choosing Custom Options” later in this chapter.

- 2 Drag the Battery Conservation slider to the setting you want.

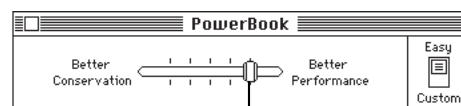

Battery Conservation slider

Better Performance allows you to work with the fewest interruptions. If you can't plug in the computer, Better Conservation gives you more work time.

3 Close the PowerBook control panel.

If you don't use the computer for several minutes (how many depends on which setting you choose), it goes to sleep without any action on your part.

To put the computer to sleep before automatic sleep takes effect, choose Sleep from the Special menu or use the Sleep Now module in the Control Strip.

To wake the computer from sleep, press any key (except Caps Lock).

Automatic sleep does *not* take effect under the following circumstances:

- AppleTalk is turned on in the Chooser and the power adapter is plugged in.
- Your computer is connected to a shared disk on the network.
- Your computer's serial port is in use.
- Your computer is docked in Duo Dock or Duo Dock II.

More about automatic sleep

The Battery Conservation slider controls three power conservation features: system sleep, screen dimming, and hard disk spin down.

- *System sleep* is a state in which your computer uses only the power it needs to maintain the contents of RAM (such as any open programs and documents, and various control panel settings). If you have a PowerBook Duo 280c, you'll see a flashing green light above the display when the PowerBook is in sleep.
- *Screen dimming* saves battery power by automatically dimming the backlight of your PowerBook's display screen.
- *Hard disk spin down* stops your computer's internal hard disk from spinning when it isn't being used. If the PowerBook is in sleep, the hard disk automatically spins down.

Notice there are five settings on the Battery Conservation slider:

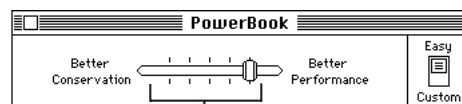

The five settings in the Battery Conservation slider indicate the time it takes for your computer to go to sleep, the screen to dim, and the hard disk to spin down.

The time it takes for each feature to take effect depends on the settings you choose. If you drag the slider toward Better Conservation, it takes less time for the system to sleep, the hard disk to spin down, and the screen to dim.

The table indicates how the battery conservation settings correspond to the time before each power saving feature takes effect:

Minutes it takes if you choose

	Conservation			Performance	
System sleeps	2	3	6	8	15
Hard disk spins down	1	2	3	6	8
Screen dims	1	2	3	4	5

Choosing Custom options

For more options that affect your computer’s power consumption, slide the switch to Custom in the PowerBook control panel.

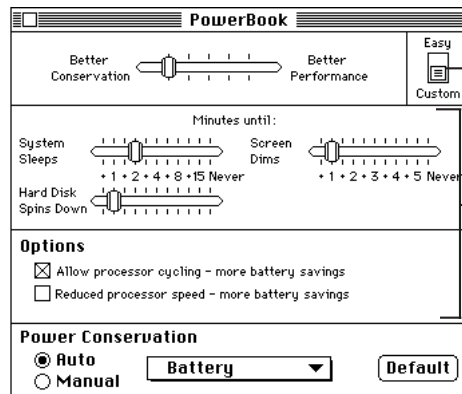

Slide this switch to Custom view.

In Custom view, you have these additional conservation options. (However, reduced processor speed is not available on the PowerBook Duo 280 and 280c.)

Battery Conservation settings

The Battery Conservation slider works as described in the previous section. In Custom view, you can also use three individual sliders controlling system sleep, screen dimming, and hard disk spinning down.

As you drag the Battery Conservation slider, the three individual sliders change. Likewise, when you drag one of the three individual sliders, the Battery Conservation slider is affected.

To use the sliders:

- 1 Choose Control Panels from the Apple (🍏) menu, and open the PowerBook control panel. (Or use the Power Settings module in the Control Strip to open the PowerBook control panel.)
- 2 Slide the switch to Custom.
- 3 Drag the sliders to choose the settings you want.

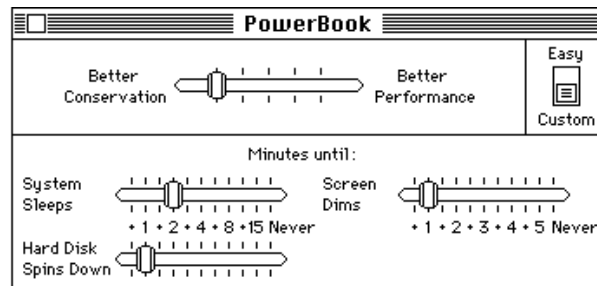

The battery conservation slider reflects the changes you make.

- 4 Close the PowerBook control panel.

Processor cycling

If the computer is not doing anything for a few seconds, it reduces the speed of its microprocessor. The microprocessor comes back up to speed instantaneously when you resume work. This feature is called processor cycling. Processor cycling conserves battery power. Your computer automatically comes with processor cycling turned on, and it is highly recommended that you work with processor cycling on.

Note: Processor cycling does not occur when your PowerBook is docked in a Duo Dock or Duo Dock II. See Chapter 8 for more information on Duo docks.

In a few cases, processor cycling can cause programs to slow down. If a program performs very slowly, you can turn off processor cycling temporarily. Follow these steps.

- 1 Choose Control Panels from the Apple (🍏) menu, and open the PowerBook control panel. (Or use the Power Settings module in the Control Strip to open the PowerBook control panel.)
- 2 Slide the switch to Custom.

- 3 Click the “Allow processor cycling” checkbox to remove the X.

Options

- Allow processor cycling - more battery savings
- Reduced processor speed - more battery savings

This feature does not appear if you have a PowerBook Duo 280 or 280c.

- 4 Close the PowerBook control panel.

To turn processor cycling back on, click the “Allow processor cycling” checkbox again.

IMPORTANT To conserve battery power, turn processor cycling off only when using programs that it interferes with. Turn processor cycling back on again as soon as possible.

Processor speed

The reduced processor speed feature appears in the PowerBook control panel if you have a PowerBook Duo 230. Reducing processor speed allows you to slow the computer’s microprocessor speed (from 33 to 16 MHz). Some programs may work more slowly, but you may gain up to 10–15 minutes of work time before you need to recharge the battery. (The amount of time you gain depends on how you are using the computer.)

To slow the processor speed, follow these steps.

- 1 Choose Control Panels from the Apple (🍏) menu, and open the PowerBook control panel. (Or use the Power Settings module in the Control Strip to open the PowerBook control panel.)
- 2 Slide the switch to Custom.
- 3 Click the “Reduce processor speed” checkbox to select it.

Options

- Allow processor cycling - more battery savings
- Reduced processor speed - more battery savings

- 4 Choose Restart from the Special menu.

The computer runs at the lower microprocessor speed until you click the “Reduce processor speed” box again to remove the check and then restart the computer.

Power conservation

Your PowerBook keeps track of what power source you are using and can change the power conservation settings to maximize battery conservation and performance for both the battery and the power adapter.

To change the power conservation settings, follow these steps:

- 1 Choose Control Panels from the Apple () menu, and open the PowerBook control panel. (Or use the Power Settings module in the Control Strip to open the PowerBook control panel.)
- 2 Slide the switch to Custom.
- 3 If necessary, click the Auto button to select it.

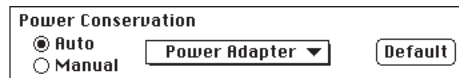

When Auto is selected, the computer will automatically use the settings you specify in step 5 whenever the selected power source is being used. (You can temporarily override your settings by returning to the PowerBook control panel and selecting Manual.)

- 4 Choose the power source in the pop-up menu.

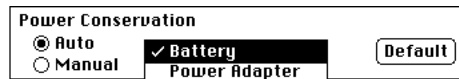

- 5 Drag the sliders to the settings you want for the selected power source.

To use the preset power conservation settings for the selected power source, click Default. See “Adjusting the Battery Conservation Settings” earlier in this section for more help.

- 6 Close the PowerBook control panel.

Read this chapter for help using custom options on your PowerBook Duo and for tips on traveling and storing your computer.

7

Customizing and Traveling With Your PowerBook



Customizing your PowerBook

There are several ways you can customize your PowerBook Duo to make your day-to-day work easier:

- **Reconnecting to shared disks** If you use your PowerBook Duo on a network to connect to shared disks, the AutoRemounter control panel lets you reconnect automatically.
- **Using a RAM disk** Using a RAM disk saves you time and battery power. When you create a RAM disk, its contents are saved in the System Folder when you shut down your PowerBook, and then copied back to the RAM disk the next time you turn the computer on.
- **Improving the pointer display** You can set options to make the pointer more visible on the screen.
- **Printing later** You can set up documents to print the next time you connect to the network printer.

These features are described in the next sections.

Automatically reconnecting to shared disks

Your PowerBook disconnects from any shared disks it's connected to when you turn it off or restart it, or when it is in sleep. By using the AutoRemounter, your PowerBook can reconnect to shared disks automatically when you turn it back on (or wake it from sleep). In addition, if you connect a hard disk to your PowerBook while it's in sleep, the hard disk appears on the desktop when you wake it up.

- 1 Choose Control Panels from the Apple () menu and open the AutoRemounter control panel.



AutoRemounter

- 2 If you want to reconnect to shared disks only when you wake the computer from sleep, click After Sleep.

If you want to reconnect when you restart the computer as well as after sleep, click Always.

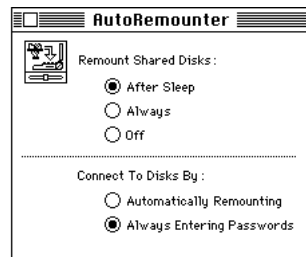

- 3 If you want the computer to ask for your password when you reconnect to shared disks, click Always Entering Passwords. Otherwise click Automatically Remounting.

For better privacy and security, have your computer ask for your password before reconnecting to shared disks.

- 4 Close the AutoRemounter control panel.

Setting up a RAM Disk

Using a RAM disk saves power because it avoids using the PowerBook's hard disk while you are running the PowerBook from its battery. Any files that are copied to the RAM disk are saved in the System Folder on the hard disk when you shut down your PowerBook. The next time you start up your PowerBook, the files are copied back to the RAM disk automatically. This feature is called a *persistent* RAM disk. It allows you to use your RAM disk without having to rebuild it every time you restart your PowerBook.

There are two ways to set up a RAM disk, depending on the amount of memory in your computer. The first way allows you to keep application programs and files in RAM. The second way—for maximum battery conservation—allows you to use your RAM disk as the startup disk.

To set up a RAM disk, you need more than 4 MB of RAM in your computer.

If you have less than 8 MB of memory

If you have less than 8 MB of memory, set up a RAM disk that contains the applications and files you use most.

- 1 Create a folder called "RAM Disk Backup."**
- 2 Put into the RAM Disk Backup folder your favorite application(s) and files you frequently use.**

Try to keep additions to this folder to a minimum.

- 3 Select the RAM Disk Backup folder. Then choose Get Info from the File menu in the Finder, find the size of your RAM Disk Backup folder, and close the Get Info window.**

You'll need to remember the size of your RAM Disk Backup folder. Write it down if you need to.

- 4 Choose Control Panels from the Apple () menu and open the Memory control panel.**



Memory

The Memory control panel appears.

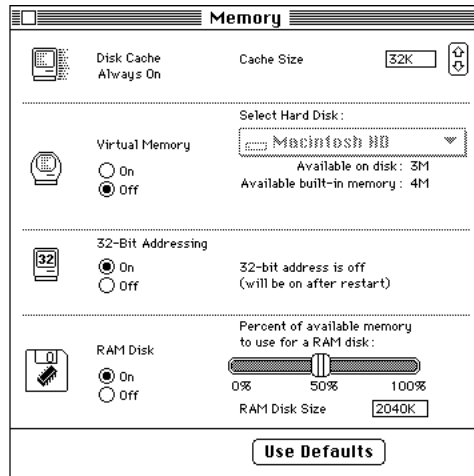

5 Click the **On** button under **RAM Disk**.

6 Drag the slider to set the percentage of memory to use for the **RAM disk**.

Adjust the size to fit the contents of your **RAM Disk Backup** folder. Make sure you allocate enough **RAM** to fit the size of your folder, or you will have to repeat this step.

7 Close the **Memory control panel** and restart your **PowerBook**.

A **RAM Disk** icon appears on your desktop.

8 Copy the contents of your **RAM Disk Backup** folder to your **RAM disk**.

9 See “Using the **RAM Disk**” later in this section.

IMPORTANT When you need to turn off the computer, make sure you choose **Shut Down** from the **Special** menu. If you use the power switch to turn off your computer, you will lose the contents of the **RAM disk**.

If you have at least 8 MB of memory

If your PowerBook has 8 MB of memory or more, you can set up a RAM disk that contains the files needed to start up your PowerBook. This provides maximum battery conservation.

- 1 Select the System Folder on your hard disk and choose Duplicate from the File menu**

This creates a folder called “System Folder copy.”

- 2 Remove any extra extensions, fonts, and control panels you don’t use.**

Make sure not to delete the files called Finder and System from the System Folder copy, or the file called Assistant Toolbox from the Extensions folder in the System Folder.

- 3 Create a folder called “RAM Disk Backup.”**

- 4 Put the System Folder copy, your favorite application program or programs, and files you frequently use into the RAM Disk Backup folder.**

Try to keep additions to this folder to a minimum.

- 5 Select the RAM Disk Backup folder. Then choose Get Info from the File menu in the Finder, find the size of your RAM Disk Backup folder, and close the Get Info window.**

- 6 Choose Control Panels from the Apple (⏏) menu and open the Memory control panel.**



Memory

The Memory control panel appears.

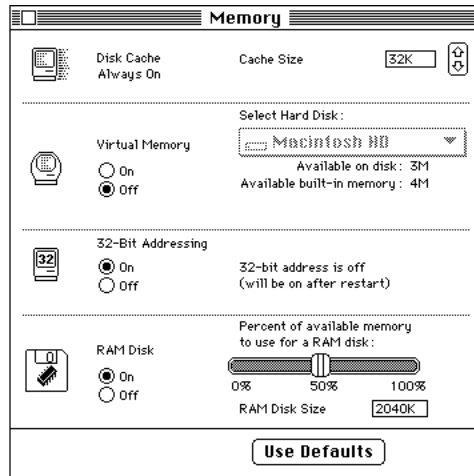

- 7** Click the On button under RAM Disk.
- 8** Drag the slider to set the percentage of memory to use for the RAM disk.

As you drag the slider, the number in the RAM Disk Size box changes. Make sure that the number (the amount of memory) is larger than the size of your RAM Disk Backup folder.

- 9** Close the Memory control panel and restart your computer.

A RAM Disk icon appears on your desktop.

- 10 Copy the contents of your RAM Disk Backup folder to your RAM disk.
- 11 Choose Control Panels from the Apple () menu and open the Startup Disk control panel.
- 12 Select your RAM disk in the Startup Disk window and close the Startup Disk control panel.
- 13 Choose Restart from the Special menu.
- 14 See “Using the RAM Disk” (the following section).

IMPORTANT When you need to turn off the computer, make sure you choose Shut Down from the Special menu. If you use the power switch to turn off your computer, you will lose the contents of the RAM disk.

Using the RAM Disk

- 1 Start up the application programs and files on the RAM Disk while your PowerBook is plugged into the power adapter.**

Using the power adapter saves your battery.

- 2 Put your PowerBook to sleep.**

- 3 Unplug the power adapter.**

Your documents will be loaded into RAM when your PowerBook comes out of Sleep.

- 4 While you are running your PowerBook off the battery, try to avoid using any files that are not on the RAM Disk.**

- 5 When you save new files, save them to the RAM Disk.**

Improving pointer display

You may notice that the pointer sometimes disappears from your PowerBook's screen when you move the pointer quickly. You can set your trackball (or external mouse) to have “tracks” so you can always see the pointer on the screen. You do this in the Mouse control panel.

- 1 Choose Control Panels from the Apple () menu and open the Mouse control panel.



The following control panel appears:

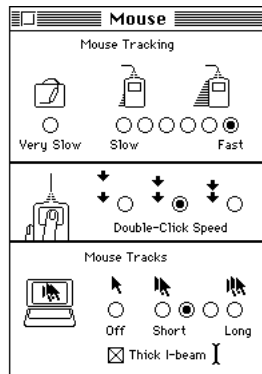

- 2 Click the mouse tracks length you want.
- 3 To display a thicker I-beam on your PowerBook, click the checkbox labeled “Thick I-beam.”

This makes the I-beam more visible.

- 4 Close the Mouse control panel.

Printing later

If you use a PostScript™ laser printer (such as a Laserwriter Pro 600) on a network, you can set up documents to print the next time you connect to the network printer.

- 1 Choose Print in the application program you are using.**

Click Print in the dialog box.

The following dialog box appears:

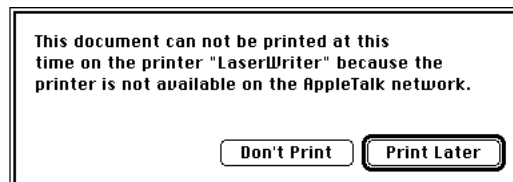

- 2 Click Print Later.**

The next time you connect to an AppleTalk network, this document is printed.

Traveling with the PowerBook

The safety instructions in the first part of this book also apply when you are traveling. In addition, note these precautions:

- Do not transport your PowerBook while it is turned on. Put your computer to sleep or shut it down before you move it.
- Transport batteries either inside the computer or in the protective case provided. Do not transport unprotected batteries.
- Do not check your computer as baggage. Carry it with you.
- Have security officials manually inspect your computer and disks if you do not want to pass them through X-ray machines.
- Be prepared to show security officials that your computer is working. Have a charged battery or a power adapter ready to use.
- Some airlines may restrict or prohibit the use of computers in flight. Check ahead to find out what restrictions, if any, apply.
- Take the necessary plug adapters if you're traveling overseas. (You may need to use them with the power adapter.) You do not need a voltage transformer. The power adapter can handle 90 volts to 260 volts AC (48 Hz to 62 Hz).

Check the diagrams below to determine which plug adapters you'll need, or ask your travel agent.

Outlet Type	Locations
	United States, Canada, parts of Latin America, Japan, Korea, the Philippines, Taiwan
	The former Soviet Union, most of Europe, parts of Latin America, the Middle East, parts of Africa, Hong Kong, India, most of South Asia
	Mexico, United Kingdom, Ireland, Malaysia, Singapore, parts of Africa
	China, Australia, New Zealand

Storing the PowerBook

- 1 Save your work on a hard disk or floppy disks.**
- 2 Choose Shut Down from the Special menu.**
- 3 Close the display.**
- 4 Recharge the battery.**

Be sure your battery is fully charged if you are taking the computer places where you cannot plug it in.

- 5 Store the computer in a cool, dry place.**

Storage temperatures should remain between 10°C and 40°C (between 50°F and 104°F). Avoid leaving the computer where temperatures may be extreme or unpredictable—in the trunk of a car, for example.

Service and support

If your computer is malfunctioning but does not appear to be physically damaged, shut it down (and leave the power adapter plugged in, if possible) until you can get help.

If you know or suspect that your computer is physically damaged, disconnect the power adapter, remove the battery, and do not use the computer until it can be repaired.

See the service and support information that came with your computer for numbers to call for assistance.

This chapter describes the options available for expanding your PowerBook Duo.

8

Building a PowerBook Duo System

You can expand your PowerBook Duo to give you more power and work options with accessories such as:

- the PowerBook Duo Dock and Duo Dock II
- the PowerBook Duo MiniDock
- the PowerBook Duo Floppy Adapter

A brief overview of these accessories is in this chapter. Instructions for using them comes with each product. You can purchase any of these products from an Apple-authorized dealer.

The PowerBook Duo Dock and Duo Dock II

The PowerBook Duo Dock and Duo Dock II are the most versatile expansion options for the PowerBook Duo. A dock itself is not a computer—you need a PowerBook Duo to use it. When a PowerBook Duo is “docked” by inserting it into a Duo Dock, Duo Dock II or Duo MiniDock, you can have the video, storage, and input/output capabilities available on most desktop Macintosh computers.

The drawing below shows one of many possible PowerBook Duo systems.

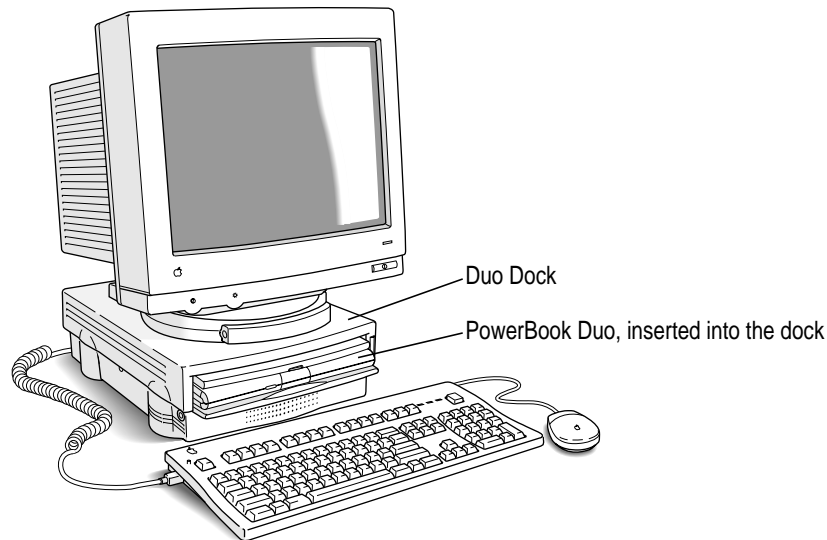

The Duo Dock and Duo Dock II come with many built-in features; several optional features are also available. These features include:

- an internal 14 MB floppy disk drive
- an optional internal SCSI hard disk drive (any available capacity that meets Apple's specifications; up to 1 inch high)
- standard ports including SCSI (with an HDI-30 connector), monitor, printer, modem, Apple Desktop Bus (ADB), sound input, and sound output. On the Duo Dock II or upgraded Duo Dock, an EtherTalk port is also provided.
- a separate mouse and keyboard
- slots for two NuBus cards for Ethernet, Token Ring, additional video, or other capabilities. (Note that if you use two NuBus cards in your Duo Dock or Duo Dock II and you dock a PowerBook Duo 280 or 280c, the bottom of your PowerBook Duo may feel warm when you eject it from the dock. This is normal and will not harm your PowerBook Duo.)
- a math coprocessor (FPU) on the Duo Dock II or upgraded Duo Dock (a socket for an optional math coprocessor is provided on the Duo Dock) if you are using the dock with a PowerBook Duo 230

- built-in video support for the following monitors:
 - Macintosh 12" Monochrome Display
 - Macintosh 12" RGB Display
 - AppleColor High-Resolution RGB Monitor (13")
 - Macintosh Color Display (14")
 - Apple Macintosh Portrait Display (15")
 - Macintosh 16" Color Display
 - VGA monitors (requires MAC-VGA adapter)
 - Super VGA (56 Hz) (requires MAC-VGA adapter)
 - Macintosh Two-Page Display (Duo Dock II or upgraded Duo Dock only)
 - Macintosh 21" Color Display (Duo Dock II or upgraded Duo Dock only)
 - Apple 17" Multiple Scan Display (Duo Dock II or upgraded Duo Dock only)
 - Apple 20" Multiple Scan Display (Duo Dock II or upgraded Duo Dock only)
- 1 MB VRAM for 16-bit color on color monitors 16" or less, 8-bit grayscale on the Apple 15" portrait monitor and the Macintosh Two-Page Display, and 8-bit color on color monitors 17" or greater. (The Duo Dock requires a 512K VRAM SIMM expansion card for 16-bit color.)
- an automatic insert/eject feature to ensure reliable docking
- a key-operated lock to prevent theft of the docked PowerBook Duo
- a 32K RAM cache function that automatically speeds up the performance of a docked PowerBook Duo by as much as 20 percent (The RAM cache function is available only with a PowerBook Duo 230 computer docked in either a Duo Dock II or an upgraded Duo Dock.)
- a slot door that protects the interior of your Duo Dock II when your PowerBook is not docked

The PowerBook Duo MiniDock

The PowerBook Duo MiniDock allows you to connect a wide variety of devices to the PowerBook. Like the Duo Dock, the Duo MiniDock with peripheral devices connected to it is not a computer—you need a PowerBook Duo to make the system work.

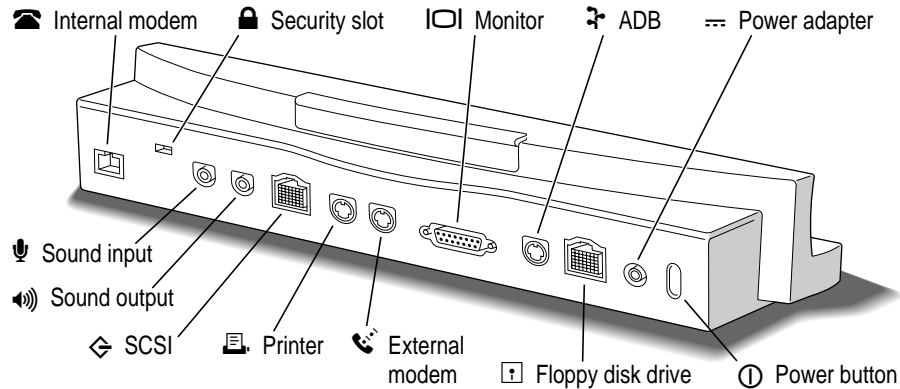

The minidock attaches to the back of the PowerBook Duo and allows you to use the following types of equipment with your computer:

- any one of these Apple monitors:
 - Macintosh 12" Monochrome Display
 - Macintosh 12" RGB Display
 - AppleColor High-Resolution RGB Monitor (13")
 - Macintosh Color Display (14")
 - Apple Macintosh Portrait Display (15")
 - Macintosh 16" Color Display
- up to three Apple Desktop Bus (ADB) input devices (such as a keyboard or mouse)
- an external 1.4 MB floppy disk drive
- up to six SCSI devices including hard disk drives, CD-ROM drives, and scanners
- a printer
- an external modem
- LocalTalk cables
- external microphone, headphones, or speakers

The PowerBook Duo Floppy Adapter

The PowerBook Duo Floppy Adapter allows you to connect an external 1.4 MB floppy disk drive (HDI-20) and up to three Apple Desktop Bus (ADB) devices—such as a keyboard or mouse—to your computer.

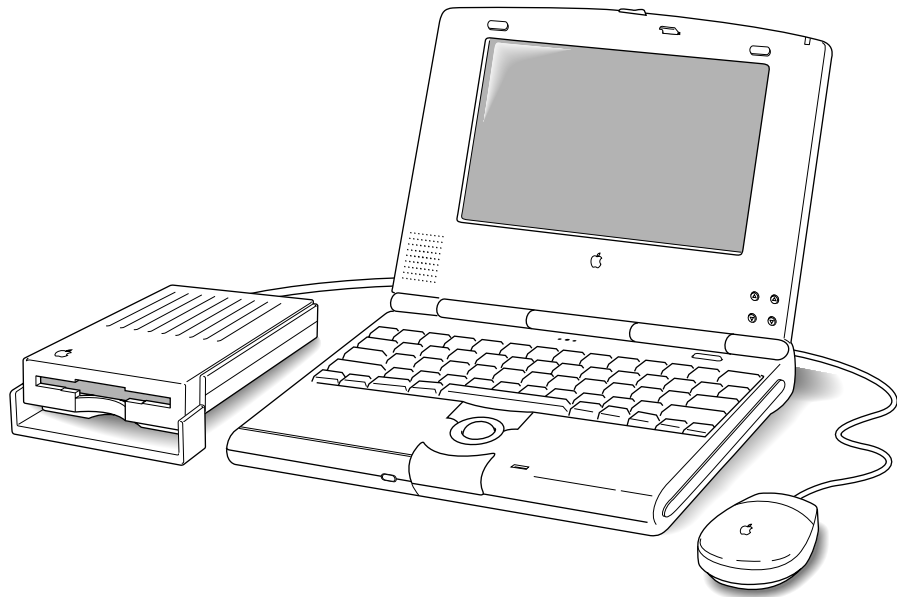

Using other equipment with your Duo system

If you have a Duo system that includes a Duo Dock or a MiniDock, you can connect other equipment such as an external modem, printer, or a SCSI device.

Connecting a modem

Apple offers an optional, low-power, internal fax/data modem for your computer. See the modem manual for information about this modem and how to use it. You can connect an external modem to

- the printer/modem port on the PowerBook Duo
- the modem port on a Duo MiniDock
- the modem port on a Duo Dock

To connect an external modem to your PowerBook, follow these steps:

- 1** Make sure the computer is in sleep or shut down.
- 2** Connect the modem to a power source and to the phone line.
See the documentation that came with the modem.
- 3** Make sure the modem is turned off.
- 4** Connect the modem cable to the printer/modem port (PowerBook Duo) or the modem port (Duo Dock or Duo MiniDock).



Printer/modem port icon

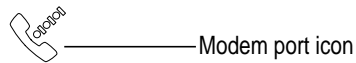

Modem port icon

5 Turn on the modem.

6 Wake or restart the computer.

If your computer does not have an internal modem, the external modem is ready to use.

If your computer does have an internal modem, continue with step 7.

7 Choose Control Panels from the Apple () menu and open the PowerBook Setup control panel.



PowerBook Setup

8 Click the Normal button.

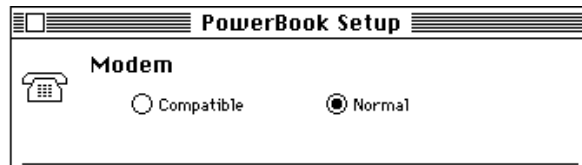

9 Close the control panel.

The external modem is ready to use. If you have problems connecting to the external modem after following these steps, then repeat steps 1 through 7, but choose Compatible instead of Normal in the PowerBook Setup control panel.

When you are connected to an external modem in the Compatible mode, you cannot use the printer/modem port on your PowerBook Duo for anything else.

If you have both an internal and an external modem, remember to select the modem you want to use in the PowerBook Setup control panel before opening your telecommunications program.

Connecting a printer

The printer/modem port on the PowerBook Duo, and the printer port on a Duo Dock or a Duo MiniDock, can accept either a direct cable connection (to a printer such as the StyleWriter) or a network cable connection (to a printer such as the LaserWriter IINTX).

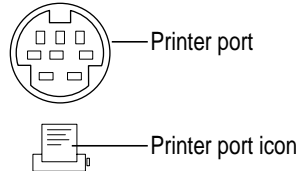

Some printers, including the Personal LaserWriter SC, are connected through the SCSI port.

If you are connecting a serial printer (such as a LaserWriter LS or a StyleWriter), make sure that the modem selection in the PowerBook Setup control panel is set to Normal. See “Connecting a Modem” earlier in this chapter.

Follow the instructions that came with your printer to connect it to your computer.

Connecting sound input and output devices

The Duo Dock and the Duo MiniDock have a sound input port (marked with the icon ) to which you can connect a microphone to record sounds on your computer. (Sound recording is described in the chapter on sound and color in the *Macintosh Reference* book.)

WARNING Do not plug a sound output device (such as a pair of headphones) into the sound input port. Doing so may damage your audio equipment.

The Duo Dock and the Duo MiniDock also have a sound output port (marked with the icon ) to which you can connect speakers, an amplifier, headphones, or other audio output devices. The sound output port accepts a standard stereo miniplug, like that used to connect headphones to a portable tape player.

Adding memory to your computer

Your PowerBook computer comes with at least 4 MB of RAM. By adding memory upgrade cards you can increase your computer's memory. (Note that any time you have more than 8 MB of RAM, you need to turn on 32-bit addressing. See the section on turning on 32-bit addressing in the *Macintosh Reference* book for help.) You can find out how much memory your computer has by choosing About This Macintosh from the Finder's Apple menu.

Apple provides memory upgrades through its authorized dealers. Memory upgrades are also available from other vendors; ask your dealer for more information. It is recommended that memory upgrades be installed by an Apple-authorized dealer.

Your PowerBook computer also supports virtual memory, a feature that makes use of hard disk space to provide additional RAM.

Using a monitor for presentations

Once you have attached an external monitor to your PowerBook Duo MiniDock, you can use that monitor to show whatever is displayed on your built-in display. This “video mirroring” capability is useful when you’re making a presentation to a group. You turn video mirroring on or off in two places:

- the Video Mirroring module in the Control Strip (See Chapter 5 for instructions on using the Control Strip.)
- the PowerBook Display control panel

To use the PowerBook Display control panel:

- 1 Choose Control Panels from the Apple () menu and open the PowerBook Display control panel.



PowerBook Display

- 2 Click the On button under Video Mirroring.

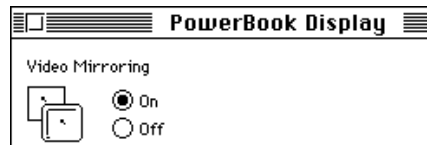

- 3 To turn off video mirroring, click Off.

Note that video mirroring is not available while your PowerBook is docked in a duo dock. This feature is available only while docked using a minidock.

Using SCSI Devices

For help with SCSI devices, see Chapter 9.

Refer to this chapter for information about connecting SCSI devices and using your PowerBook Duo as a SCSI disk.

9

Using SCSI Devices



A SCSI device is any product—including hard disk drives, CD-ROM drives, scanners, and printers—that connects with your computer by means of a standard electronic interface called Small Computer System Interface (SCSI).

Connecting SCSI devices

You can attach up to six SCSI devices to your computer by linking them together in a chain that starts at your dock's SCSI port.

There is a SCSI port on the PowerBook Duo Dock and the PowerBook Duo MiniDock. (There is no SCSI port on the PowerBook Duo.) The SCSI port looks like this:

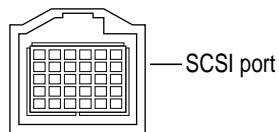
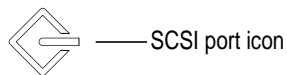

To connect a SCSI device to the SCSI port on your PowerBook, you need an Apple HDI-30 SCSI System Cable.

Connecting SCSI devices to your PowerBook involves these steps:

- installing software
- setting SCSI ID numbers
- checking that the SCSI chain is properly terminated
- connecting cables

These steps are described in the following sections.

Installing software

Many SCSI devices come with software that allows your computer to communicate with them. These programs are called drivers. (If no drivers come with a device, then it doesn't need any.) To install a driver, follow the instructions that came with the device.

Setting SCSI ID numbers

Each device in a SCSI chain must have a unique ID number between 1 and 6 so the computer can identify it properly.

WARNING Using two or more devices with the same SCSI ID number can cause your equipment to malfunction. You could lose information as a result.

Your computer has the SCSI ID number 7, and its internal hard disk has the number 0.

The ID numbers of Apple SCSI devices can be set as follows.

- 1 Make sure the SCSI device is turned off.**

If the device is already part of a SCSI chain, make sure that all devices in the chain are turned off, including the computer.

- 2 **Locate the ID number indicator and switch (usually on the back panel of the SCSI device).**

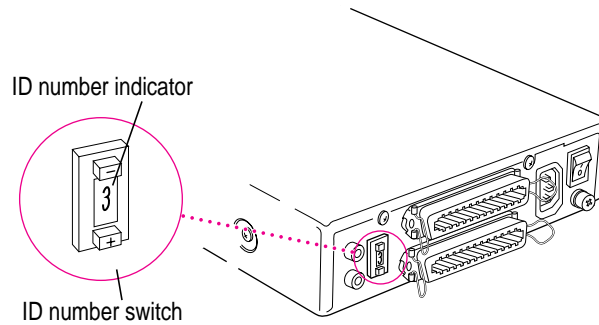

- 3 **Check the ID numbers of all the devices you want to connect.**

If all the devices have unique ID numbers, you can continue with the next section, “Checking That the SCSI Chain Is Properly Terminated.”

- 4 **If you need to change a device’s ID number, choose an available number between 1 and 6.**

IMPORTANT Hard drives installed in the Duo Dock or Duo Dock II are preset to have a SCSI ID number of 1. SCSI devices connected to a Duo Dock or Duo Dock II should use SCSI ID numbers 2 through 6.

- 5 **Press the appropriate button to increase or decrease the SCSI ID number.**

If your SCSI device does not have an ID number switch like the one pictured above, consult the manual that came with your SCSI device for details.

Checking that the SCSI chain is properly terminated

To ensure accurate transmission of information, a chain of SCSI devices must have a terminator at each end. Terminators are built into some SCSI devices.

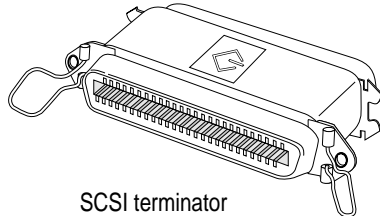

SCSI terminator

- The Duo Dock and the Duo MiniDock both have built-in terminators.
- External SCSI devices from Apple do not have built-in terminators.
- External SCSI devices from other vendors may have built-in terminators; see the documentation that came with the device.

What these facts mean to you: You do not need to add a terminator at the beginning of the chain. You need to make sure that the last device in the chain has an internal or external terminator, and that no other devices have terminators.

If you are attaching one SCSI device

Make sure that there is *one* of the following:

- an internal terminator in that device
- an external terminator attached to that device

If you are attaching more than one SCSI device

Make sure that both of these conditions exist:

- an internal terminator in, *or* an external terminator attached to, the last device
- no other terminators (internal or external) in the chain

If you have too many devices with internal terminators, your Apple-authorized service provider can remove extra terminators.

SCSI chain configurations are shown in the illustration on the following page.

Connecting cables

WARNING When making SCSI connections, *always* turn off power to all devices in the chain. If you don't, you could lose information and damage your equipment.

- 1 Shut down your PowerBook and turn off all SCSI devices in the chain.
- 2 To connect the first device, use an Apple HDI-30 SCSI System Cable.

Attach the smaller end of the cable to the SCSI port (marked with the icon ⇄) on the Duo Dock or the Duo MiniDock, and the larger end of the cable to either SCSI port on the device.

- 3 To connect the next device, use a SCSI peripheral interface cable.

The connectors on the ends of the cable are the same. Attach one connector to the available SCSI port on the first device, and the other connector to either SCSI port on the next device.

- 4 Repeat step 3 for each additional device you want to connect.

The illustration shows where to add cable terminators.

Connecting one SCSI device

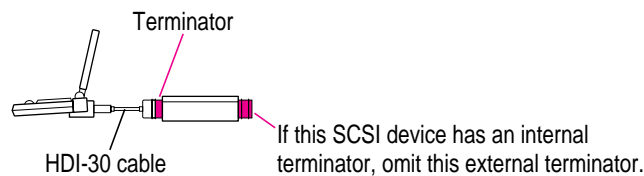

Connecting more than one SCSI device

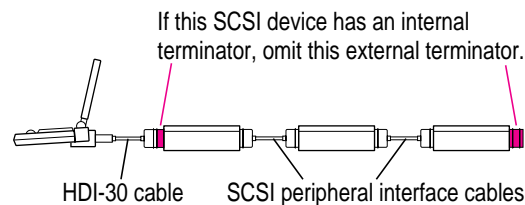

IMPORTANT The total length of a SCSI chain should not exceed 20 feet (6 meters). Apple SCSI cables are designed to meet this restriction. If you are using SCSI cables from another vendor, check the length of the chain.

WARNING Once your SCSI devices are connected, always turn them on before turning on your PowerBook. If you turn the computer on first, it may not be able to start up, or it may not recognize the SCSI devices.

Using your PowerBook as a SCSI disk

You can purchase a cable called the Apple HDI-30 SCSI Disk Adapter which lets you connect your PowerBook to another computer and use the PowerBook as a hard disk. The PowerBook appears as a hard disk icon on the screen of the other computer, and you can transfer information between the computers by dragging files. This feature is called SCSI disk mode. The PowerBook Duo Dock and Duo Dock II do not support SCSI disk mode.

WARNING Follow the steps for connecting and disconnecting SCSI devices carefully to avoid loss of information and damage to your equipment.

Connecting your PowerBook as a SCSI disk

Before making any connections, you need to assign a SCSI ID number to the PowerBook.

- 1 Choose Control Panels from the Apple () menu of your PowerBook computer.
- 2 Open the PowerBook Setup control panel.



PowerBook Setup

- 3 In the SCSI Disk Mode section of the control panel, click the ID number you want to assign.

If you are connecting the PowerBook to an existing SCSI chain, make sure to give it an ID number different from those of the other devices.

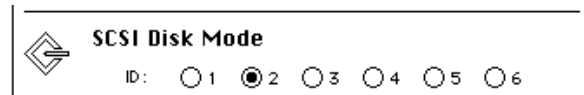

- 4 Close the PowerBook Setup control panel.
- 5 Turn off the PowerBook by choosing Shut Down from the Special menu.
- 6 Shut down the computer you want to connect your PowerBook to, and turn off other devices in the SCSI chain.
- 7 Connect the PowerBook to the other computer or to the end of the SCSI chain.

WARNING Always shut down the PowerBook before connecting or disconnecting the SCSI disk adapter cable. Connecting the adapter cable while the computer is turned on can damage the computer.

8 Turn on the PowerBook by pressing the power button.

After a few seconds a SCSI icon appears on the screen, showing the ID number you assigned in step 3.



WARNING If you do not see the SCSI icon, and the PowerBook either starts normally or displays an error message, choose Shut Down (if you can) and then immediately disconnect your PowerBook from the SCSI chain. Then go back and repeat steps 6 through 8.

(If you can't choose Shut Down, try pressing the power button. If you cannot shut down your PowerBook, disconnect your PowerBook from the SCSI chain or you may lose information.)

9 Turn on the other SCSI devices in the chain, if any.

10 Turn on the other computer.

The PowerBook appears as a hard disk icon on the screen of the computer you connected it to. You can now transfer and use files as if the PowerBook were an external disk drive.

Simplifying the SCSI disk connection process

If you regularly plan to use your PowerBook as a SCSI disk with the same computer, you can leave the SCSI disk adapter cable attached to the other computer or its SCSI chain. When you want to use your PowerBook as a SCSI disk, simply shut down all devices and connect the adapter cable to the SCSI port on your PowerBook.

These cables can stay attached to your desktop Macintosh or its SCSI chain.

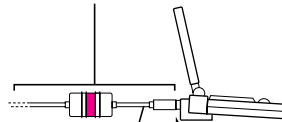

HDI-30 SCSI disk adapter Connect and disconnect your computer here.

WARNING Always disconnect your PowerBook from the adapter cable when you are not using it as a SCSI disk. Your PowerBook will not work correctly if the adapter cable remains attached.

Drawing battery power in SCSI disk mode

Your PowerBook continues to draw battery power when you use it as a SCSI disk. Low battery power is indicated by a blinking low-power warning on the PowerBook's screen.

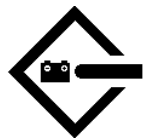

If you see this warning while using your computer as a SCSI disk, either plug in the power adapter or quit SCSI disk mode, as described in the next section, so you can remove the battery for recharging.

Quitting SCSI disk mode

- 1 Shut down the computer your PowerBook is connected to.
- 2 Turn the PowerBook off by holding down the ⌘ (Command) key and power button on the back of your PowerBook (marked with the icon ①) at the same time.
- 3 Turn off any other SCSI devices in the chain.
- 4 Disconnect the PowerBook from the adapter cable.

If you plan to connect your PowerBook regularly to the same computer, you can leave the adapter cable attached to the SCSI chain or the other computer. See “Simplifying the SCSI Disk Connection Process,” earlier in this chapter.

IMPORTANT Do not leave the adapter cable attached to the PowerBook. If you do, the computer will behave as though it is still in SCSI disk mode when you try to restart.

- 5 If necessary, disconnect the adapter cable from the other computer or its SCSI chain.

Your equipment is now ready for normal use.

Refer to this chapter for solutions to some common problems.

10

Tips and Troubleshooting



This chapter describes possible causes and solutions for some common problems you may have with your PowerBook Duo, the Duo Dock, the Duo MiniDock, or associated equipment provided by Apple. Try the possible solutions in the order they are listed until the problem is solved. Check explanations and instructions in this book and in the *Macintosh Reference* book for additional help.

WARNING If you have a problem with your PowerBook Duo and nothing presented in this chapter or in the manuals that came with your computer solves it, consult the service and support information that came with your computer for instructions on how to contact an Apple-authorized service provider or Apple for assistance. If you attempt to repair the computer yourself, any damage you may cause to the computer will not be covered by the limited warranty on your computer. Contact an Apple-authorized dealer or service provider for additional information about this or any other warranty question.

The PowerBook Duo

The computer won't start.

- The computer may be on, but the screen brightness or contrast may be turned down. Adjust the brightness and contrast controls.
- Try holding the Power On key down for 30 seconds, or until you hear a chime.
- The battery may be drained. Plug in the power adapter, wait 30 minutes, and then try to turn on the computer.
- Take out the battery, unplug the power adapter, and let the computer sit for 15 minutes. Then replace the battery, plug in the power adapter and try again.

The computer won't restart.

Try to restart your computer using one of the following methods. Try them in the order given.

- **Press the ⌘ (Command), Control, and Power On keys at the same time.**

When pressed at the same time, these keys turn the computer off and back on. Restarting the computer this way does not affect your RAM disk (if you created one) or its contents.

- **Hold down the power button (at the back of the computer) for 5 seconds to turn the computer off, then press the Power On key.**

Turning the computer off with the power button erases the contents of a RAM disk.

- **If you have a floppy disk drive, restart from a floppy disk.**

1. Insert the *Disk Tools* disk into the floppy disk drive.
2. Press the Power On key.

If the computer restarts from a floppy disk, there is probably a problem with your hard disk. You may be able to fix the problem yourself (using the Disk First Aid program or another disk repair program; see the *Macintosh Reference* book for help). Or you may prefer to take the computer to your Apple-authorized service provider.

- **If you have a PowerBook Duo MiniDock and an Apple HDI-30 SCSI Disk Adapter cable, connect your PowerBook Duo to a desktop Macintosh and start up the PowerBook Duo as a SCSI disk.**

With your PowerBook Duo acting as a SCSI drive, you can reinstall system software from the desktop Macintosh on to the PowerBook's internal hard disk.

Chapter 9 and Appendix A, respectively, contain specific instructions for connecting your computer to a desktop Macintosh and reinstalling system software.

The computer just stopped.

- The computer may have gone to sleep. Press any key (except Caps Lock) or the Power On key to wake it again.
- The battery may have drained so far that the computer has put itself to sleep to protect the contents of RAM. Plug in the power adapter and then press the Power On key.
- The computer may have “crashed” due to temporary software problems. Click the Restart button on the screen (if you see one) or choose Restart from the Special menu. If these suggestions don't work, restart the computer using the methods described in “The computer won't restart.”
- Interrupt the program by pressing the ⌘ (Command), Option, and Esc (Escape) keys at the same time. Click the Force Quit button in the dialog box that appears, and then restart the computer.

The computer exhibits odd behavior, such as many unexplained system failures.

- A common cause of unexplained problems is multiple System Folders on your computer's startup disk. The icon for the System Folder that the PowerBook is using to operate looks like this:



System Folder

Use the Find command in the Finder's File menu to locate any other System Folders, and throw them in the Trash. (If you use a RAM disk as your startup disk, do not delete the System Folder from your RAM Disk Backup folder.)

- You may have a virus on your hard disk. Obtain a virus-detection program, use it to check all your disks, and eliminate any viruses the program finds.
- You may be using a program that's not compatible with your computer's system software. Check the manual that came with the program or contact the manufacturer.
- You may have added a control panel or extension that is incompatible with other programs you use. Restart the computer, holding the Shift key down, until you see the message "Extensions off." If this solves the problem, remove any control panels or extensions you recently installed.
- You may need to reinstall system software. See Appendix A for instructions on installing system software.

Power

The battery is draining too fast.

- Turn down the screen brightness, turn off virtual memory, move the battery conservation slider in the PowerBook control panel to Better Conservation, or work with the power adapter plugged in.
- Your computer supplies power to the modem whenever a communications program is open. Quit your communications program if you aren't using it.
- If you aren't using network services, you can also save power by turning off AppleTalk in the Chooser.
- Your battery may need to be reconditioned completely. See Chapter 6 for help.
- You may not have the correct power adapter. Make sure that if you are using a PowerBook Duo 230 or 280, you have a 25-watt adapter, and if you are using a PowerBook Duo 280c, you have a 36-watt adapter.
- Older PowerBook batteries do not hold a charge as well as new ones do. You may need to replace the battery.

The battery can't be recharged.

- There may be a loose connection. Take the battery out and put it back in the computer.
- If all connections are OK, then the battery is probably damaged or dead. You'll need to obtain a replacement battery from an Apple-authorized dealer.

- If you are recharging the battery in a recharger, you may have an older recharger with a new battery. Check to make sure you have the correct recharger for your type of battery.

The computer goes to sleep too often.

- Open the PowerBook control panel and slide the slider to Better Performance.

The PowerBook won't run off the battery or the battery won't charge.

- Make sure your PowerBook is running system software version 7.1 or later. You may have a new battery which requires this system software.
- There may be a loose connection. Take the battery out and put it back in the computer.

The computer doesn't go to sleep automatically.

- You may have dragged the slider to Never in the Custom view of the PowerBook control panel. Drag the slider to a lower setting.
- You may be connected to a shared disk on the network. If you are not using the information on the shared disk, disconnect from it.
- The printer/modem port may be in use. Quit your telecommunications program or turn off background printing in the Chooser (if the documents you're printing can wait until later).
- When application programs are working in the background, the computer doesn't go to sleep. In this case, choose Sleep from the Special menu.
- The computer does not go to sleep if AppleTalk is active and the power supply is plugged in. Turn AppleTalk off in the AppleTalk Switch module in the Control Strip.
- The computer does not go to sleep if it is being used in a Duo Dock.
- The computer does not go to sleep if you are using it with a Duo MiniDock and an external monitor or SCSI device is attached.
- The computer does not go to sleep if you are using it with a Duo MiniDock and you started or restarted the computer after connecting it to another device.

See Chapter 6 for more information about batteries and power consumption.

The screen

The screen looks blurred or out of focus.

- The viewing angle may not be optimal. Tilt the display on its hinge until the screen looks better.

The screen is too dark.

- When you first turn on your computer, it may take several minutes for the screen brightness to “warm up,” especially if you’ve chosen a high setting.
- The screen brightness or contrast may not be optimal for the surrounding lighting. Adjust the brightness or contrast setting.
- The screen dims automatically when the battery starts to run low. You may need to recharge or replace the battery before you can turn up the brightness.

The screen is flickering.

- This problem sometimes occurs when your screen is set to display the maximum number of grays or colors. Try adjusting the contrast control, or select fewer grays or colors in the Monitors control panel.

There are ghost images or black dots on the screen.

- When the computer is left on for many hours, temporary images may appear on the screen. Put the computer to sleep. The longer the computer was left on, the longer it will take for the images to fade, but they will eventually disappear.

The pointer moves too fast or too slowly.

- You need to adjust the pointer’s tracking speed. Open the Mouse control panel and choose a more comfortable setting.

The pointer won't move at all.

- A software problem may have caused the computer to “freeze.” Restart the computer by pressing the power button on the back of the computer, or pressing the Command (⌘), Control, and Power On keys simultaneously. You will lose any work you have not saved.
- Interrupt the program by pressing the ⌘ (Command), Option, and Esc (Escape) keys at the same time. Click the Force Quit button in the dialog box that appears, and then restart the computer.

A window has disappeared.

- Another open window on the desktop may have covered the one you're looking for. Move, resize, close, or hide windows you aren't using until you see the one you want.
- Windows belonging to open but inactive programs may be hidden. Choose Show All from the Application menu to show hidden windows and choose the correct application program from the Application menu for the window you want to view.

An icon is blinking in the menu bar.

- A program needs attention. For example, you may have set the Alarm Clock to go off at a particular time, or PrintMonitor may be alerting you to a printing problem. Make the program active by choosing the icon for the application program in the Application menu, and take the necessary action.



The trackball

The trackball doesn't work smoothly; it sticks or jumps when rolled.

- There may be dust or dirt inside the trackball mechanism. To clean the trackball, follow these steps.
 1. Remove the trackball by turning the trackball retainer ring counterclockwise, and lifting the trackball out of its cavity.

You may need to use a pen or your fingernail to lift the trackball out.
 2. Locate the small rubber rollers at the left and bottom sides of the trackball cavity.

The rollers may look like small rings or wheels.
 3. Use any reasonably clean, blunt object (your fingernail) to scrape off the rollers. Do not use any liquid inside the computer.
 4. Replace the trackball and its retainer ring.

You just cleaned the trackball, and it feels worse than before.

- This problem is related to the way the trackball is lubricated. After you use it for a few minutes, the problem should go away.

Memory

A “not enough memory” message appears when you try to open a program.

- Quit any programs you aren't using, then try again to open the program you want. If that doesn't work, restart the computer. Sometimes restarting makes additional memory available.
- If you are using a RAM disk or a disk cache, reduce its size in the Memory control panel and then restart the computer.
- If you consistently want to open more programs than memory allows, you can purchase a memory expansion card from your Apple-authorized dealer.

Virtual memory is supposed to be on, but it's off.

- If you set aside virtual memory space on the hard disk in or connected to the Duo Dock or the Duo MiniDock, virtual memory is not available when you use the computer away from the dock. The next time you dock, virtual memory is turned back on automatically. You can set aside space on your computer's internal hard disk if you want to use virtual memory when the computer isn't docked.

The Duo Dock

You can't insert the computer into the dock.

- The dock may be locked. Turn the key to the vertical (unlocked) position and insert the computer again.
- The door covering the dock connector in the Duo Dock II may not be open. Open the door and insert the computer again.
- The PowerBook may not be shut down. Remove the computer, open the display, choose Shut Down from the Special menu, and try again.

You can't turn on the docked computer.

- Make sure all your equipment is connected properly and then press the Power On key on your external keyboard. If nothing happens, press the power switch on the back of the dock.

The computer is on but the monitor is blank.

- Make sure that the monitor is plugged in and that its power switch is on. Then adjust the brightness and contrast controls as necessary.

You can't eject the computer from the dock.

- The dock may be locked. Turn the key lock to the vertical (unlocked) position and press the eject button again.
- Power to the dock may be interrupted. Insert the dock's key, a small screwdriver, or a similar object into the square hole on the side of the dock and press gently to eject the computer. (When the dock is locked, the hole is not available.)

See the manual that came with your Duo Dock for more information.

The Duo MiniDock

You can't turn on the docked computer.

- Make sure your equipment is connected properly and then press the Power On key on any of your keyboards. If nothing happens, press the power button on the back of the minidock.
- The computer's battery may need to be recharged. Plug in the computer's power adapter and then try pressing the Power On key again.

The battery drains very quickly when you use the computer with the minidock.

- If you are using an external monitor, SCSI equipment, a printer, or an external modem, you need to plug in the computer's power adapter.

The menu bar appears on the PowerBook's screen, but you want it to appear on an external monitor.

- Make sure the external monitor is connected properly and turned on.
- Make the external monitor the main monitor by opening the Monitors control panel, dragging the small menu bar icon from the small screen to the large one, and restarting the computer.

See the manual that came with your Duo MiniDock for more information.

SCSI devices

You can't turn on the computer after connecting a SCSI device.

- SCSI devices must be turned on before the computer itself. Turn on the SCSI device(s) first, and then turn on the computer.

The computer doesn't recognize your SCSI devices.

- The devices may be off. Check to make sure that they are plugged in and turned on.
- If the device is a disk drive, it may need to be initialized before you can use it. See the instructions that came with the device.
- The software (driver) needed to run the device may not be installed in your System Folder. See the instructions that came with the device.
- Two or more devices in the SCSI chain may have the same ID number. Check the ID number of each device to make sure each one has its own number between 1 and 6, and change any numbers that are not unique. (If there is a hard disk in your Duo Dock, that disk has the ID number 1.)
- When connecting SCSI equipment, it is important to use the right cables and the correct number and placement of cable terminators. Check the cables and terminators in the SCSI chain and make sure that all cables are firmly attached. The first and the last device in a SCSI chain should be terminated.
- A PowerBook in sleep connected to a Duo MiniDock cannot recognize an attached SCSI device. Make sure the SCSI device is turned on, and then restart the computer.

See Chapter 9 for more information about working with SCSI devices.

Disk drives and disks

The computer won't start up from its hard disk, or the hard disk icon doesn't appear on the desktop.

- There may have been a temporary software problem. Turn off the computer, wait at least 10 seconds, and then turn it on again.
- If the computer is in a Duo Dock, someone may have selected the dock's hard disk as the startup disk. You can change this setting in the Startup Disk control panel.
- There may be a problem with the system software on the hard disk. Start up the computer with the *Disk Tools* disk. If the hard disk's icon appears, install system software as described in Appendix A. Disk repair programs can sometimes fix problems of this kind.
- The information on the disk drive may be damaged. Try using a disk repair program to repair or recover the information (such as Disk First Aid or HDSC setup on the *Disk Tools* disk). If this doesn't work, you'll need to reinitialize the hard disk. See the *Macintosh Reference* book for instructions.
- There may be a mechanical problem with the disk drive. If none of the above suggestions works, call Apple (see the service and support information for the phone number), or take the computer to an Apple-authorized service provider.

The hard disk keeps stopping and starting again.

- The hard disk may be going to sleep to conserve power. Open the PowerBook control panel and move the Battery Conservation slider toward Better Performance.

The icon of a floppy disk doesn't appear on the screen.

- There may be a problem with the disk or disk drive. Try inserting a different disk. If its icon does appear, the original disk is probably damaged. You may be able to repair the disk or recover some of the information on it. If the icon of the second disk does not appear either, take the disk drive to an Apple-authorized service provider for repair.
- Restart the computer, holding the Shift key down until you see the message "Extensions off." If this solves the problem, remove any control panels or extensions you recently installed.

A high-density (1.4 MB) disk you use with your PowerBook computer is not recognized by another Macintosh.

- Some disk drives cannot recognize high-density disks. Try inserting an 800K or 400K disk in the disk drive of the other Macintosh. If that works, copy your files to an 800K disk or a 400K disk. If you regularly plan to use floppy disk drives of different types, use the lower-capacity disks in all drives.

You can't eject a disk from a floppy disk drive.

- There may be a temporary mechanical problem with the disk drive. Restart the computer and hold down one of the trackball buttons while the computer starts up. If that doesn't work, carefully insert the end of a straightened paper clip into the small hole near the disk drive's opening and push gently until the disk is ejected.

A message says that a disk is not initialized—but you know that it is.

- The disk may not be seated properly in the disk drive. Eject it and try inserting it again.
- The disk may be damaged. If you insert another disk in the drive and the message does not appear, you can assume that the original disk needs repair. If the second disk is also not recognized, call Apple (see the service and support information for the phone number), or take the disk drive to an Apple-authorized service provider.

You can't delete a file.

- The floppy disk may be locked. Unlock it by sliding the tab so that it covers the hole at the corner of the disk.
- The file may be locked. You can unlock it in its Info window (choose Get Info from the File menu). Or you can hold down the Option key while you choose Empty Trash from the Special menu.
- An application program may be using the file. Quit the program.

You can't save or copy files onto a floppy disk.

- The disk may be locked. Unlock it by sliding the tab so that it covers the hole at the corner of the disk.
- The disk may be full. Delete files you no longer need or use a different disk.

See the *Macintosh Reference* book for more information about working with disk drives and disks.

Modems

The external modem doesn't work.

- The modem may be turned off or improperly connected. Make sure it is turned on and that all connections are correct.
- The modem port may not be activated. Open the PowerBook Setup control panel and make sure that Normal is selected.

The internal modem doesn't work.

- The modem connection may not be activated. Open the PowerBook Setup control panel and make sure that Compatible is selected.

See the modem manual for more information about using your modem.

Printers

Your computer can't find the printer.

- The printer may be turned off. Turn it on.
- The printer may not be selected in the Chooser. Open the Chooser and select the printer you want to use.

Your printer does not appear in the Chooser window.

- The printer may not be connected properly. Check the connections between your computer and the printer, including relevant sections of the network if appropriate.
- The printer software may not be in your System Folder. Close the Chooser and install the software you need.
- AppleTalk must be active before you can use a network printer. Make sure that AppleTalk is active in the Chooser.
- If your network has zones, the printer you want may not be in the currently selected zone. Make sure the correct zone is selected.

The network printer keeps restarting.

- Someone on the network may be using a version of printer software that is different from the version used by others on the network. Everyone connected to a network should use the same printer software version. Consult the network administrator for more information.

Nothing happens, or you see an error message, when you try to print.

- The printer may not be selected in the Chooser. Open the Chooser and reselect the printer.
- The printer may not be turned on. Make sure it is plugged in, turned on and warmed up.
- The printer may be out of paper or have some other problem. Check the printer status lights and any messages on your screen.
- If an error message states that the printer could not print your document, turn the printer off for at least 10 seconds. Then turn it on again, wait for it to warm up, and try to print again.

Your documents are printed with the wrong fonts.

- The printer may not have your fonts in its memory and may be substituting other fonts. You may be able to add the necessary fonts to your printer (see the *Macintosh Reference* book for instructions), or print on a different printer that has the fonts you want. If you have a LaserWriter printer, you can turn off Font Substitution in the Page Setup dialog box.

See the *Macintosh Reference* book for general information about printing documents. See your printer manual for more information about your printer's features or problems with the printed output.

Networks

You can't find or can't open icons needed to set up file sharing.

- One or more icons may be in the wrong place. Make sure that the Sharing Setup icon is in the Control Panels folder, and that the File Sharing Extension file, the Network Extension file, and the AppleShare file are in the Extensions folder. (Both folders are inside the System Folder.)
- Some network software may not be installed. Use the Installer to custom install the appropriate network software. See Appendix A for help using the Installer.

The shared disk you want to connect to does not appear in the Chooser window.

- AppleTalk must be active before you can use a shared disk. Make sure that AppleTalk is active in the Chooser.
- If your network has zones, the shared disk you want may not be in the currently selected zone. Make sure the correct zone is selected.
- The computer that the disk is on must be turned on before the disk can be shared. Make sure that computer is on and that it has file sharing turned on.

You can't open a shared disk or folder.

- You may not have the access privileges needed to use the disk or folder. Ask the network administrator or the owner of the shared item to give you access.
- You may have entered your name or password incorrectly when you tried to open the shared disk or folder. Check with the owner of the item to make sure you are entering your name and password correctly, and try again.

You can't connect to your own computer from another Macintosh.

- Make sure that your computer is turned on, file sharing is turned on for both computers, you have the correct access privileges, and you entered your name and password correctly.

See the *Macintosh Reference* book for general information about using your computer on a network.

Application programs

A program won't open.

- Some programs can't be opened from a locked floppy disk. Make sure the disk is unlocked. (Unlock a disk by sliding the tab so that it covers the hole at the corner of the disk.)
- The program may be damaged. Recopy it from a known good source (such as the original program disk).
- There may not be enough memory available to open the program. Quit other programs or change this program's memory size in the Info window.

A program runs very slowly.

- Some programs are slowed by processor cycling. You can turn processor cycling off; see Chapter 6.

A message says that a program could not be found.

- You may be trying to open a document created with a program you don't have on your computer, or created with a different version of the program. Obtain the correct program and version. Or, open the document with another program that can read its format. (If another program can open a document, the program icon becomes highlighted when you drag the document icon on top of it.)

A program doesn't work, or malfunctions consistently.

- You may have more than one copy of the program on your hard disk. Remove extra copies by dragging them to the Trash.
- The program may be damaged. Recopy it from a known good source (such as the original program disk).
- Your version of the program may be incompatible with your system software. Consult the software manufacturer to find out which version of the program you should be using.
- The program may be using less memory than it needs to work with your documents. Choose Get Info from the File menu and increase the memory size.
- You may have added a control panel or extension that is incompatible with other programs you use. Restart the computer, holding the Shift key down, until you see the message “Extensions off.” If this solves the problem, remove any control panels or extensions you recently installed.

You just did something you didn't mean to do.

- If you have not yet taken any other action, you can usually undo your most recent action (even if you aren't sure what it was). Most programs have an Undo command in the Edit menu. Choose Undo to go back one step in your work. In most programs, you cannot undo more than one action.

See the documentation that came with your programs for more information about their operation and features.

Refer to this chapter when you need to install or reinstall the system software on your PowerBook Duo.

Appendix A Installing System Software



System software is the set of programs and other files that your computer uses to start itself up, keep track of your files, and run the application programs you use. When you turn on your computer, it looks for a disk that contains the system software. System software is always in a folder called the System Folder.

Any disk that contains a correct version of system software is a *startup disk*. The startup disk is usually the hard disk that's inside your computer, though another hard disk or a floppy disk can also be a startup disk.

If your computer cannot find a startup disk, it displays this icon in the middle of the screen:



If you see that icon, you may need to install or reinstall system software on your computer's internal hard disk. You can also attach your computer to an external hard disk that contains the system software.

If your hard disk already has system software on it and you see that icon: Your hard disk or system software may be damaged, or there may be problems with SCSI devices attached to your computer. (See Chapter 9 for more information on SCSI devices.) You may need to reinstall the system software. See the section on reinstalling system software later in this appendix for instructions.

Before you begin

You use the Installer program (which is found on the *Install Me First* disk) to install, reinstall, or update system software on a startup disk. When you use the Installer, you keep any special files you have installed in your System Folder.

IMPORTANT Before you install a new version of system software, make a backup copy of your current System Folder on another disk in case you need it later (to use a program that is incompatible with the new system software, for example).

To install, reinstall, or update system software, you need

- an initialized hard disk (If you have a hard disk that hasn't been initialized—that is, its icon doesn't even appear on the desktop—go to the *Macintosh Reference* book for information on initializing a hard disk.)
- access to system software (system software disks that came with your computer or access to system software over a network)

Installing system software for the first time

If you have a new hard disk or a newly initialized hard disk that does not contain system software, follow the steps in this section to do what is commonly called a “normal” installation of system software.

If you have access to the system software on a network, open the Installer program on the network and then follow the steps in this section, beginning with step 11.

If you have a PowerBook Duo Floppy Adapter attached to your PowerBook, follow all the steps.

- 1 Shut down your computer.**
- 2 Insert the *Disk Tools* disk into the floppy disk drive.**
- 3 Turn on your computer.**

The *Disk Tools* icon appears on your computer's screen.

- 4 Double-click the Disk First Aid icon.



Disk First Aid

Follow the instructions on the screen. Disk First Aid checks your hard drive for any problems.

- 5 When Disk First Aid has finished checking your hard drive, choose Quit from the File menu.
- 6 Double-click the Apple HD SC Setup icon and follow the instructions on the screen.



Apple HD SC Setup

- 7 When you are finished, choose Quit from the File Menu.
- 8 Shut down your computer.
- 9 Insert the *Install Me First Disk* into the floppy disk drive.
- 10 Turn on your computer.

The Installer program opens automatically.

11 Click OK.

The Easy Install dialog box appears.

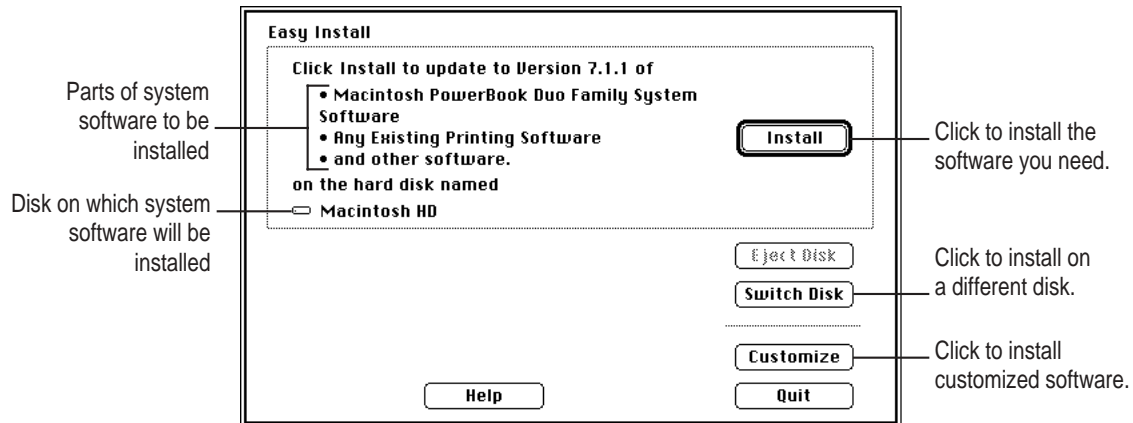

12 Make sure that the hard disk named in the box is the one that you want to install system software on.

If it isn't, click the Switch Disk button until the correct disk name appears.

13 Click Install.

14 Follow the instructions that appear on the screen.

If you are installing from floppy disks, you see messages asking you to insert different disks.

15 When you see a message reporting that the installation was successful, click Restart.

If a message reports that installation was not successful, try installing again. (Follow the instructions on the screen.)

Reinstalling system software

If your system software is damaged, you need to reinstall system software. These steps outline what is commonly called a “clean” installation of system software.

- 1 Shut down your computer.
- 2 Insert the *Disk Tools* disk into the floppy disk drive.
- 3 Turn on your computer.

The *Disk Tools* icon appears on your computer’s screen.

- 4 Double-click the Disk First Aid icon.



Disk First Aid

Follow the instructions on the screen. Disk First Aid checks your hard drive for any problems.

- 5 When you are finished, choose Quit from the File Menu.
- 6 Double-click the Apple HD SC Setup icon and follow the instructions on the screen.



Apple HD SC Setup

- 7 Click Update.
- 8 When you are finished, choose Quit from the File menu.

- 9** Check to make sure that at least 5 MB of space is available on the hard disk where you want to reinstall the system software.

Open your hard drive and choose by Icon from the View Menu. The amount of space available on the hard disk appears in the upper-right corner of the window. If there is less than 5 MB of disk space available, delete unnecessary files until you have at least 5 MB of disk space available.

- 10** Create a new folder named “Old Finder.”
- 11** Open the System Folder and drag the file called “Finder” to the Old Finder folder.
- 12** Rename the System Folder “Storage.”
- 13** Shut down your computer.
- 14** Turn on your computer.

The blinking question mark icon should appear.

If you don't see the blinking question mark: If your computer starts up, you have another System Folder on your hard disk. Find it (you can use the Find command in the File menu), and go back to step 10.

- 15** Insert the *Install Me First Disk* into the floppy disk drive.

The Installer program opens automatically.

- 16** Click OK.

The Easy Install dialog box appears.

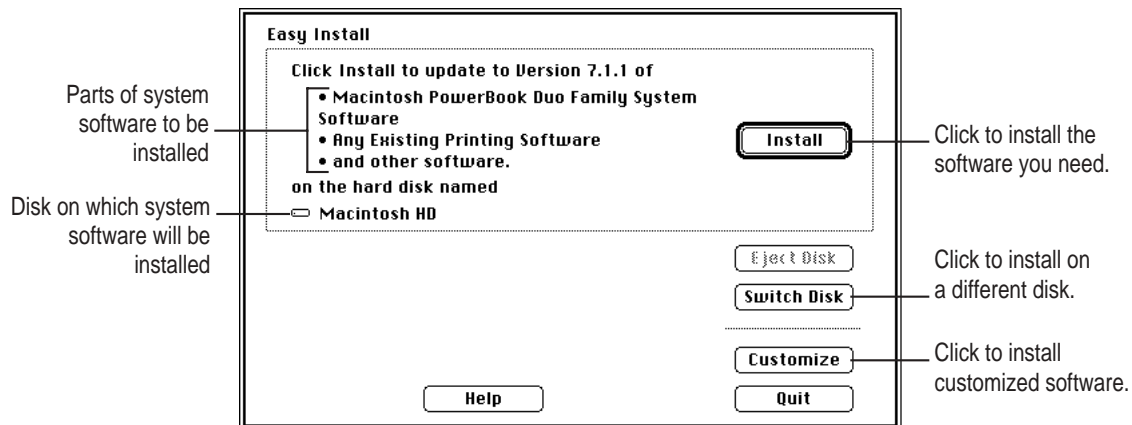

- 17 Make sure that the hard disk named in the box is the one you want to install system software on.**

If it isn't, click the Switch Disk button until the correct disk name appears.

- 18 Click Install.**

- 19 Follow the instructions that appear on the screen.**

- 20 When you see a message reporting that the installation was successful, click Restart.**

If a message reports that installation was not successful, try installing again. (Follow the instructions on the screen.)

After you are finished reinstalling the system software, make sure that your computer starts up without any problems. Once you know that the new software fixed any problems you were having before, you can copy any special software (control panels, extensions, custom utilities) back to your System Folder from the folder you renamed "Storage."

IMPORTANT Be very careful not to replace any of the files in the System Folder with files from the Storage folder.

Installing customized system software

Custom installation allows you to select just the files you want. You can use custom installation to install or update a single file or to save space on your hard disk by installing only the files you need.

- 1 Shut down your computer.**
- 2 Insert the *Install Me First* disk into the floppy disk drive.**
- 3 Turn on your computer.**

The Installer program opens automatically.

- 4 Click OK.**

The Easy Install dialog box appears.

- 5 Make sure that the hard disk named in the box is the one you want to install system software on.**

If it isn't, click the Switch Disk button until the correct disk name appears.

6 Click the Customize button.

The custom installation dialog box appears. All available components of the system software are listed.

7 Scroll through the list of items and hold down the Shift key as you click the items you want to install.

If you want to conserve space on your hard disk, select the “minimal software” option for your computer.

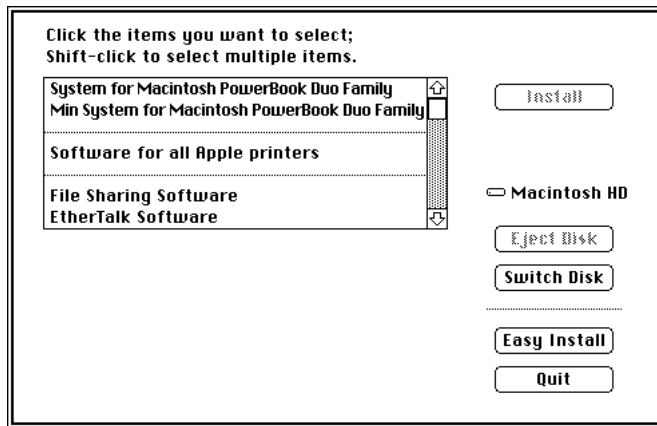

8 Click Install.

9 Follow the instructions that appear on the screen.

10 When you see a message reporting that the installation was successful, click Restart.

If a message reports that installation was not successful, try installing again. (Follow the instructions on the screen.)

Refer to this chapter when you want to use the PowerBook File Assistant that came with your computer to synchronize files.



Appendix B Using the PowerBook File Assistant



The PowerBook File Assistant is software that synchronizes files on your PowerBook and desktop Macintosh by automatically updating files whenever you make changes. With File Assistant, you can always be sure that the file you are working on is the current version.

What is file synchronization?

If you use two Macintosh computers, you may often have the same file or folder on both computers. But you may have a problem keeping track of what files are on what computer.

With the PowerBook File Assistant you can make sure you always have the most recent version of a file or folder on both computers. The process of updating the files on both computers is called *file synchronization*. With the PowerBook File Assistant, you can synchronize individual files or folders.

Before you can use the PowerBook File Assistant to synchronize files, you need to connect your PowerBook to another Macintosh. For instructions, see “Using Your PowerBook as a SCSI Disk” in Chapter 9 of this manual, or Chapter 7, “Using Your Computer on a Network,” in the *Macintosh Reference* manual.

Starting the PowerBook File Assistant

Once you have installed the PowerBook File Assistant, you are ready to decide which files you want to synchronize.

- Double-click the PowerBook File Assistant icon.



PowerBook File Assistant

The File Assistant Setup window appears:

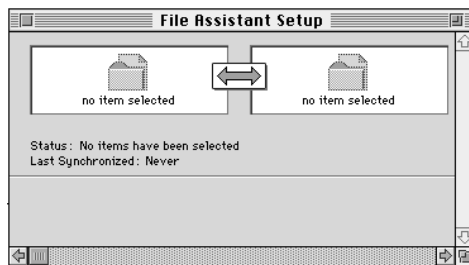

Linking files or folders for synchronization

Before you can synchronize files or folders, you need to link them. Linking joins two identical copies of a file or folder together so that when one file or folder in the pair is modified, the linked file or folder is also changed.

IMPORTANT Files cannot be linked if they are not identical copies, but you can link folders with different names or contents.

Before linking, make sure that each computer's clock is set for the same time and date. See the *Macintosh Reference* book that came with your computer for information on how to set the time and date on your computer's clock.

To link files or folders, follow these steps:

- 1 Drag the icon of a file or folder you want to link to a selection box in the File Assistant Setup window.**

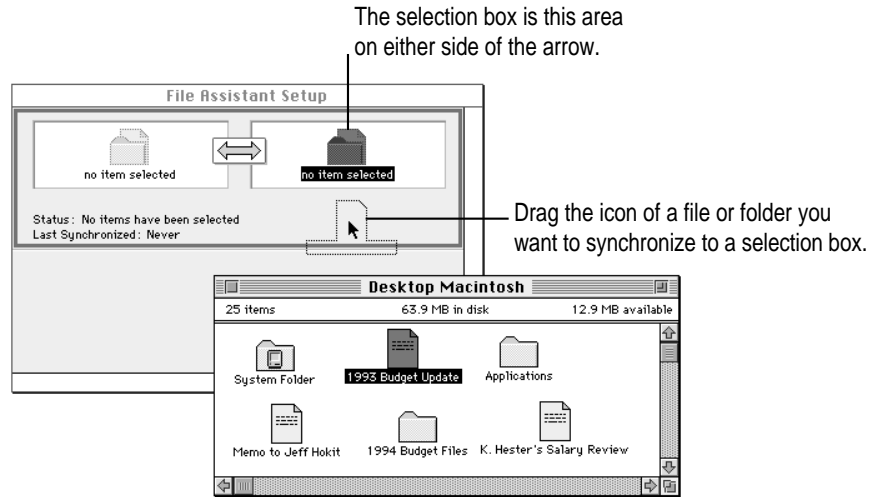

- 2 Drag the matching icon to the other selection box.**

Once you have two matching files or folders in the Setup window, you have a linked pair. Another pair of selection boxes appears. Repeat steps 1 and 2 to link more pairs of files or folders.

The setup screen grows as you add to the list of linked pairs. Use the scroll bars on the right of the screen to see parts of the list that are not in view.

Setting the direction of the link

Notice the arrow between the two linked files; this is how you can tell the direction in which the files are linked. Normally the PowerBook File Assistant synchronizes files in both directions, but you can set the direction to be one way, from either left to right or right to left.

A one-way link is helpful if you want to receive updated versions of a document from a file server on a network.

- 1 Click the pair of linked files to select it.

Click the item selection box for either file or folder in the pair.

- 2 Choose the direction you want from the Synchronize menu.

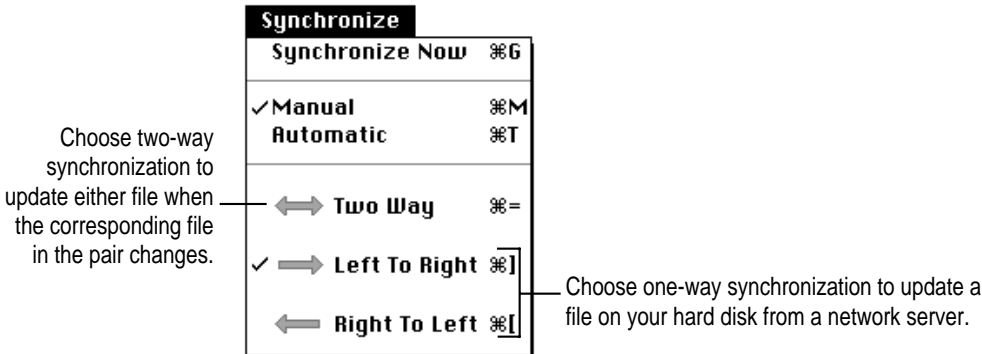

The direction of the arrow between the two linked files in the Setup window changes to reflect your choice.

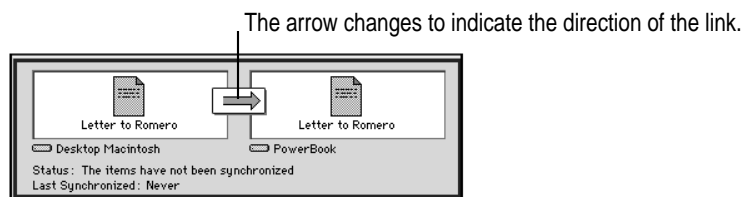

Linking non-matching folders

PowerBook File Assistant lets you link folders that have different names and contain different files.

1 Choose Preferences from the File Menu.

The following dialog box appears:

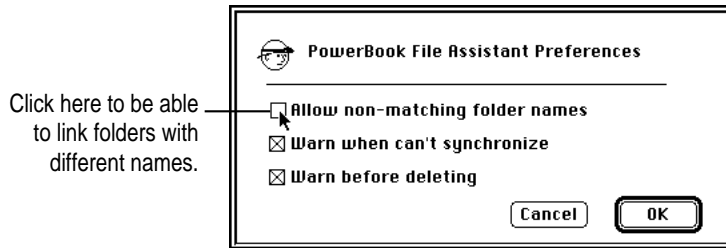

2 Click the checkbox to allow non-matching folder names.

3 Click OK.

Now you can link folders that have different names and contents. The first time you synchronize a pair of non-matching folders, PowerBook File Assistant copies all the files from one folder to the other, so that the folders have identical contents.

Deleting a linked pair

If you don't want to synchronize a linked pair anymore, you can delete the linked pair from the Setup window.

- 1 **Click the pair you want to delete to select it.**

To select more than one pair, hold down the Shift key and click other pairs.

To select all pairs, choose Select All from the Edit menu.

- 2 **Choose Delete Pairs from the Edit menu.**

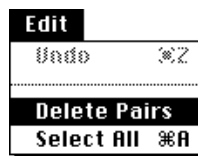

The pairs you selected are deleted from the Setup window.

Synchronizing linked folders or files

To synchronize files or folders you linked in the Setup window, you must do two things:

- Connect the disks containing the files you are synchronizing.
- Open the PowerBook File Assistant.

Now you are ready to synchronize the linked files or folders. Any time you make a change to either item, the same change is made to the linked item. If an item is deleted, you'll be asked to confirm that you want to delete the corresponding file or folder.

Information about each linked pair is displayed in the Setup window.

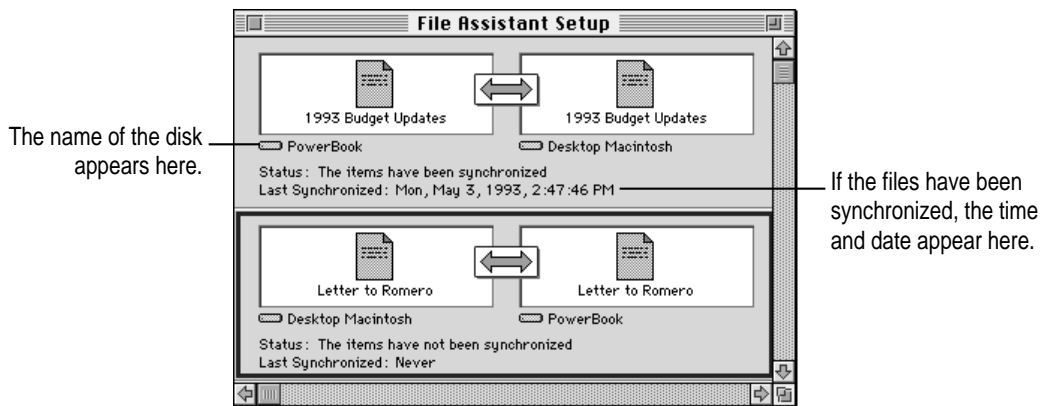

You can set PowerBook File Assistant to synchronize files either manually or automatically. You choose which you want when you link the items.

Manual synchronization

When you choose manual synchronization, you decide when you want to update a linked pair.

- 1 **Select a pair, then choose Manual from the Synchronize menu.**
- 2 **Click the arrow in the File Assistant Setup window.**

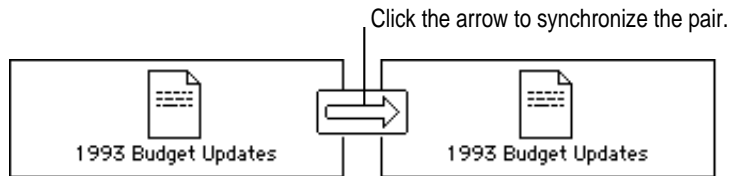

A message appears telling you that the files are being updated.

You can also manually update files that are linked by selecting the pair and then choosing Synchronize Now from the Synchronize menu.

Automatic synchronization

To update linked files automatically whenever a change is made to either of the linked files:

- **Select the pair and then choose Automatic from the Synchronize menu.**

A message appears whenever files are being updated. You can also set pairs to be updated every time you connect with another disk. See “Setting Up Completely Automatic Synchronization” later in this Appendix.

Understanding the alert messages

As you synchronize linked pairs, the PowerBook File Assistant displays alert messages about the synchronization. You can turn off the alert messages by following these steps:

1 Choose Preferences from the File menu.

A dialog box appears.

2 Click the “Warn when can’t synchronize” checkbox to deselect it.

The messages do not appear.

If you don’t want the alert message to appear when a file or folder is put in the Trash, click the checkbox next to “Warn before deleting” to deselect it. Be very careful if you turn off the alert message that warns you when files are put in the Trash. Items are put in the Trash during synchronization whenever a linked item is deleted or renamed.

3 Click OK.

Alert messages are turned off. If you want to turn them back on, choose Preferences from the File menu and click the checkboxes again to reselect them.

To turn alert messages off temporarily, hold down the Option key. While you hold down the Option key, the alert messages for any commands you execute are turned off.

Setting up completely automatic synchronization

The PowerBook File Assistant needs to be running in order to synchronize your files. To set up your system to automatically synchronize linked files:

- 1 Select the pair and then choose **Automatic** from the **Synchronize** menu.
- 2 Use the **AutoRemounter** control panel to reconnect to shared disks.

See Chapter 7 for instructions on automatically reconnecting to (“remounting”) shared disks.

- 3 Drag an alias of the **PowerBook File Assistant** icon to the **Startup Items** folder.

The Startup Items folder is in your PowerBook’s System Folder.

See the *Macintosh Reference* book for help on creating an alias.

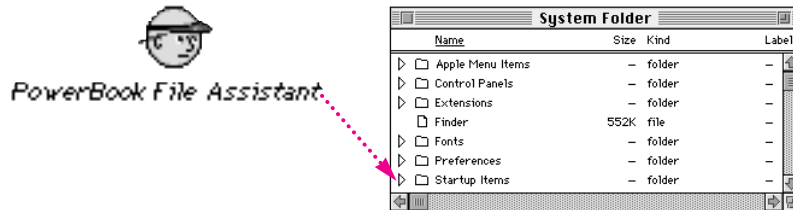

Now whenever AutoRemounter “mounts” your disks and the PowerBook File Assistant is open, all automatically linked pairs are synchronized.

Refer to this appendix for information on using the Macintosh PC Exchange program that came with your computer

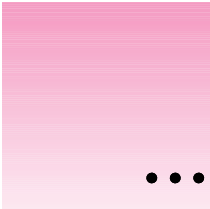

Appendix C Exchanging Files With DOS or Windows

Macintosh PC Exchange is software included with your computer that lets you easily exchange documents between your Macintosh and a DOS or Windows computer. You can use Macintosh PC Exchange to create floppy disks compatible with DOS computers.

Macintosh PC Exchange at a glance

You can open, edit, and save DOS documents using your favorite Macintosh application programs.

Using the PC Exchange control panel, you can specify which Macintosh programs are used to open DOS documents.

For example, DOS documents whose names end with this suffix . . .

. . . are to be opened by this program . . .

. . . as this type of document.

You can use and create DOS-format disks.

DOS Suffix	Application Program	Document Type
.ILL	Adobe Illustrator® 3.0	EPSF
.CAN	Canvas™ 3.0	TEXT
.WK1	Claris Resolve	TEXT
.WK3	Lotus 1-2-3	TEXT
.MDP	MacDraw Pro	PICT
.MW2	MacWrite II	TEXT
.XLS	Microsoft Excel 3.0	TEXT

Using DOS-format disks on your Macintosh

The *format* of a disk refers to the way the computer prepares the disk to receive information. Macintosh computers and DOS computers use different disk formats, but with Macintosh PC Exchange installed in your Macintosh system, your Macintosh can read disks of either format.

To use a DOS-format disk on your Macintosh, simply insert the disk into your computer's floppy disk drive. The disk's icon appears on the desktop. You can open the disk by double-clicking its icon—the same way you would open an ordinary Macintosh disk.

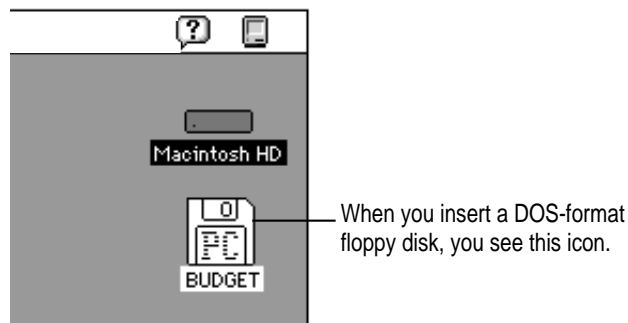

If you see a message that the disk is unreadable, see Chapter 10 of this book.

WARNING Do not attempt to repair a DOS-format disk using disk repair utility programs intended for use on the Macintosh. Doing so is likely to destroy any information on the disk. If you must repair a DOS-format floppy disk, use a disk repair utility on your DOS computer.

Creating a blank DOS-format disk

When you erase or initialize a disk on the Macintosh, you can choose its format—either Macintosh or DOS.

WARNING Before you erase or initialize a disk, be sure that the disk contains no information you want to save.

To create a blank DOS-format disk on your Macintosh, follow these steps:

1 Insert a floppy disk.

- If the disk has not been initialized, a dialog box appears in which you can specify the disk's name and format.

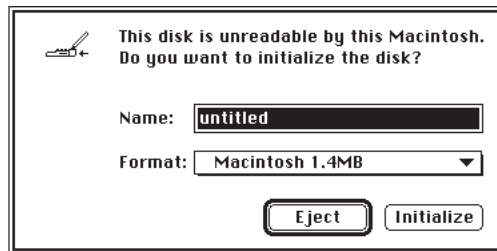

- If the disk has already been used, you'll need to erase it. Select the disk, then choose Erase Disk from the Special menu.



A dialog box appears in which you can specify the disk's name and format.

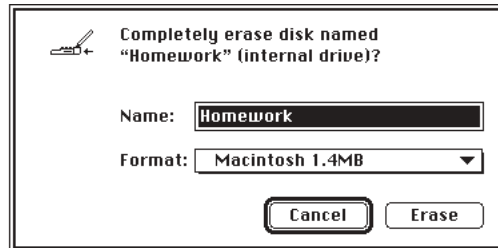

2 Type a name for the disk.

3 Choose the disk format you want from the Format pop-up menu.

The list of available formats varies depending on your disk drive and the capacity of the disk. Choose DOS if you plan to use the disk on both Macintosh and DOS computers.

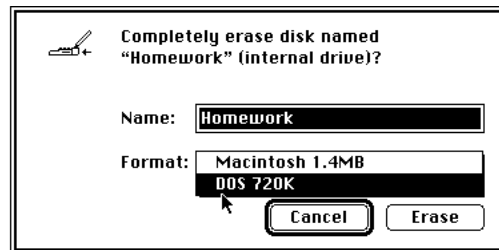

4 Click Erase (or Initialize).

If you're initializing a disk, an alert box appears. Click the Continue button.

The Macintosh prepares the disk in the format you chose.

Usually it takes less than a minute to initialize or erase a floppy disk.

However, if portions of the disk have been damaged, the initialization process may take several minutes.

If you changed the disk's format the disk's icon will change when you re-insert the disk.

Opening DOS documents on your Macintosh

Opening a document from within a Macintosh program

The surest way to open a DOS document on the Macintosh is to use the Open command from within an application program.

- 1 Open the program you want to use.
- 2 Choose Open from the File menu.

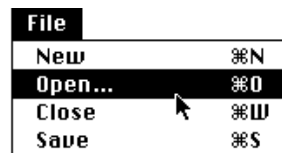

A directory dialog box appears.

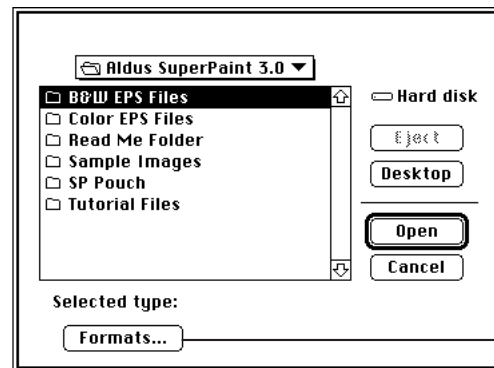

Many programs have buttons or pop-up menus that let you open or import documents of a particular file format.

- 3 Select the document you want, and click Open.

If you have problems opening the document, see Chapter 10 of this book.

Opening a document by double-clicking its icon

Before you can open a DOS document by double-clicking its icon, you need to use the PC Exchange control panel to specify which Macintosh application programs will open DOS documents, as described next.

Assigning Macintosh programs to DOS documents

Using the PC Exchange control panel, you can assign Macintosh application programs to DOS documents. For example, you can specify that all DOS documents whose filenames end with the suffix .XLS are to be opened in the Macintosh program Microsoft Excel.

The figure below shows the PC Exchange control panel with some assignments already created.

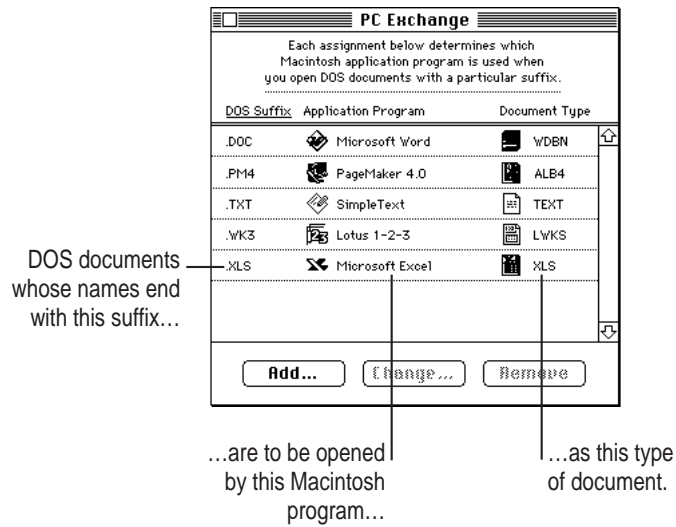

Before you can assign a Macintosh program to a group of DOS documents, there are three questions you need to answer:

- **What suffix do the documents have in common?**

Many DOS programs automatically add a three-letter suffix (or filename *extension*) to a document's name. For example, these PageMaker documents all share the suffix .PM4:

NEWS.PM4

REPORT.PM4

RESUME.PM4

- **What Macintosh application program do you want to use to open the documents?**

Each Macintosh document has a *creator*—that is, the Macintosh program used to create the document. When you double-click a document's icon, the Macintosh opens the program that created the document.

Using the PC Exchange control panel, you can assign Macintosh programs to DOS documents as “creators.”

- **What type of document is it?**

Most programs are able to open or import some, but not all, types of documents. A document's *type* is a three- or four-letter code (such as TEXT or PICT) that tells a program whether or not it can recognize the document. A program displays documents of types it can recognize in its directory dialog box.

Unless you specify otherwise, the Macintosh assumes that all DOS documents have the document type TEXT. You can assign different types to some DOS documents. See the next section.

A document's type is different from its *file format*, which refers to the way information within the document is encoded. If a program is unable to accurately interpret a document's file format, the document's formatting may be displayed incorrectly. (To find out which file formats a program can understand, refer to the documentation for the program.)

Recommended assignments for some widely used application programs

The information in this section will help you assign documents from some widely used DOS/Windows programs to some widely used Macintosh programs. (For more information, see the documentation for your application programs.)

AMI Pro (Windows), version 2.0

Documents in AMI Pro (Windows) version 2.0 are automatically saved with the suffix .SAM.





To open these documents on the Macintosh, add one of the following assignments to the PC Exchange control panel:

DOS Suffix	Macintosh application	Document type
.SAM	 MacWrite® II (version 1.1)	 TEXT
.SAM	 Microsoft Word (version 5.0)	 TEXT
.SAM	 WordPerfect (version 2.0)	 TEXT
.SAM	 WriteNow (version 2.2)	 TEXT

Lotus 1-2-3 (Windows), version 1.0

Documents in Lotus 1-2-3 (Windows) version 1.0 are automatically saved with the suffix .WK3.





To open these Lotus 1-2-3 documents on the Macintosh, add one of the following assignments to the PC Exchange control panel:

DOS Suffix	Macintosh application	Document type
.WK3	 Lotus 1-2-3 (version 1.0)	 TEXT
.WK3	 Microsoft Excel (version 3.0)	 TEXT

Microsoft Excel (Windows), version 3.0

Documents in Microsoft Excel (Windows) version 3.0 are automatically saved with the suffix .XLS.



To open these Microsoft Excel documents on the Macintosh, add one of the following assignments to the PC Exchange control panel:

DOS Suffix	Macintosh application	Document type
.XLS	 Lotus 1-2-3 (version 1.0)	 TEXT
.XLS	 Microsoft Excel (version 3.0)	 TEXT

Microsoft Word (Windows), version 2.0

Documents in Microsoft Word (Windows) version 2.0 are automatically saved with the suffix .DOC.



To open these documents in Microsoft Word (Macintosh) version 5.0, add the following assignment to the PC Exchange control panel:

DOS Suffix	Macintosh application	Document type
.DOC	 Microsoft Word (version 5.0)	 WDBN

PageMaker (Windows), version 4.0

Documents in PageMaker (Windows) version 4.0 are automatically saved with the suffix .PM4.







To open these documents in PageMaker (Macintosh) version 4.0, add the following assignment to the PC Exchange control panel:

DOS Suffix	Macintosh application	Document type
.PM4	 PageMaker (version 4.0)	 ALB4

Quattro (DOS), version 3.0

When saving documents in Quattro (DOS) version 3.0 be sure to save them with the suffix .WK1 (rather than the default suffix, .WQ1). Quattro saves documents ending in .WK1 in the Lotus 1-2-3 file format, which can be interpreted by many Macintosh spreadsheet programs.



To open these Quattro documents on the Macintosh, add one of the following assignments to the PC Exchange control panel:

DOS Suffix	Macintosh application	Document type
.WK1	 Claris Resolve™ (version 3.0)	
.WK1	 Lotus 1-2-3 (version 1.0)	 TEXT
.WK1	 Microsoft Excel (version 3.0)	 TEXT

Ventura Publisher (Windows), version 3.2

Documents in Ventura Publisher (Windows) version 3.2 are automatically saved with the suffix .CHP.

To open these documents in Ventura Publisher (Macintosh) version 3.2 add the following assignment to the PC Exchange control panel:

DOS Suffix	Macintosh application	Document type
.CHP	 Ventura Publisher (version 3.2)	 VCHP

WordPerfect (DOS) version 5.1

WordPerfect (DOS) version 5.1 does not automatically add a suffix to the names of documents. The easiest way to open WordPerfect (DOS) documents on the Macintosh is by choosing the Open command from within an application program.

Adding an assignment to the PC Exchange control panel

To add an assignment, follow these steps:

- 1 Choose Control Panels from the Apple (🍏) menu.

The Control Panels folder opens.

- 2 Open the PC Exchange control panel.

Double-click the PC Exchange icon, or select the icon and choose Open from the File menu.



PC Exchange

The PC Exchange control panel appears.

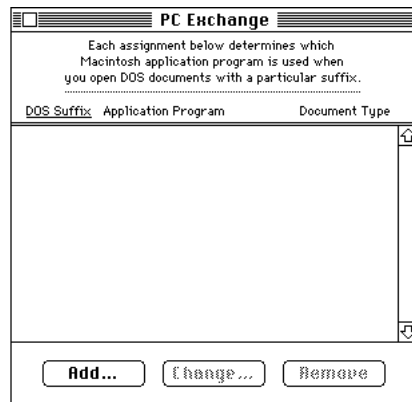

- 3 Click the Add button.



A dialog box appears in which you can specify a DOS suffix and its corresponding Macintosh application program and document type.

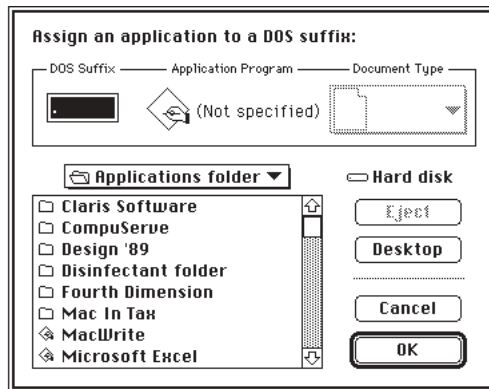

- 4 Type a three-letter DOS suffix in the DOS Suffix box.

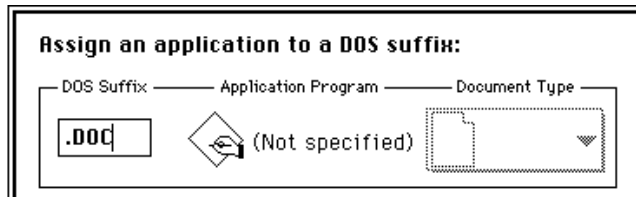

To specify which Macintosh program will open DOS documents with *no suffix*, click inside the box to set the insertion point, but leave it blank.

- 5 Select a Macintosh application program from the directory section of the dialog box.

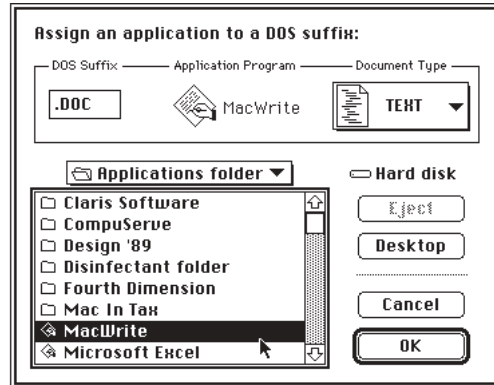

- 6 Choose a document type from the Document Type pop-up menu.

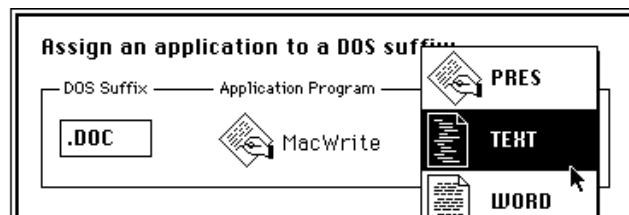

Document types are indicated by icons and four-letter codes whose meanings are seldom obvious. For help choosing the correct document type, see the information in the previous section, “Recommended Assignments for Some Widely Used Application Programs.”

If you don't know which document type to choose, try TEXT.

- 7 Once you've specified a DOS suffix, a Macintosh application program, and the appropriate document type, click OK.

The assignment is added to the list in the control panel.

Trying out an assignment

To try out an assignment you've added to the PC Exchange control panel, follow these steps:

1 Insert a DOS-format floppy disk and open its icon.

PC Exchange assignments take effect when you insert a floppy disk, or when you open a DOS-format floppy disk. (If the disk window was already open, you need to close it and open it again.)

2 Double-click the icon of a DOS document whose filename ends with the suffix you specified.

The document is opened by the appropriate Macintosh application program. (You might see a message that the document's file format is being converted.)

If you have problems opening documents, see Chapter 10 of this book.

Editing the list of assignments

You can change, remove, and sort assignments in the PC Exchange control panel.

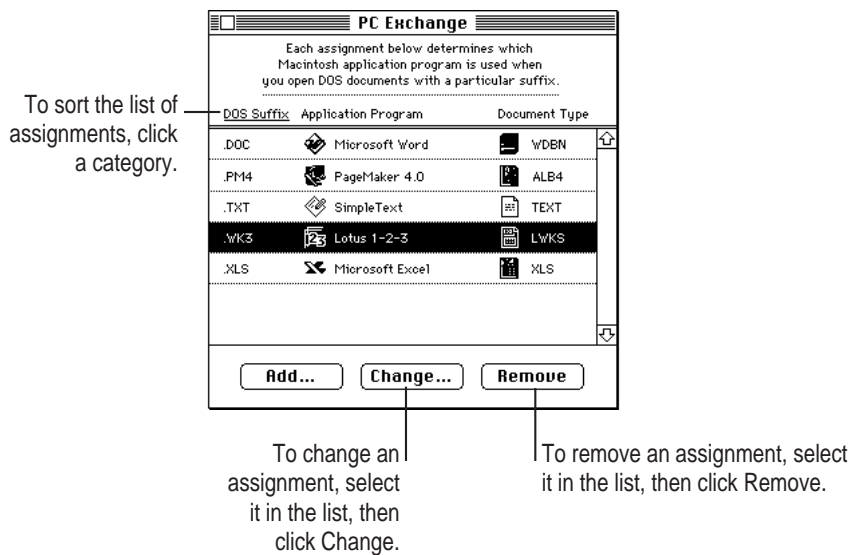

Sharing assignment lists with other users

The list of assignments is stored in the PC Exchange Preferences file. This file is stored in the Preferences folder inside the System Folder.



PC Exchange Preferences

You can make sure that every licensed user of Macintosh PC Exchange in your office uses the same assignments. Make copies of the PC Exchange Preferences file and place one copy in the Preferences folder (inside the System Folder) of each licensed user's Macintosh.

Do not change the name of the PC Exchange Preferences file.

Saving documents onto a DOS-format disk

You save documents onto a DOS-format disk the same way you save them onto a Macintosh disk—by choosing the Save command from the File menu.

IMPORTANT Be sure to leave at least 5K of extra disk space when you save or copy files onto a DOS-format floppy disk. (The Macintosh needs this space to store Macintosh-specific information about files on the disk, such as the location of icons and windows on the Macintosh desktop.)

Choosing a file format

In some programs you'll have the choice of saving the document in one of several file formats.

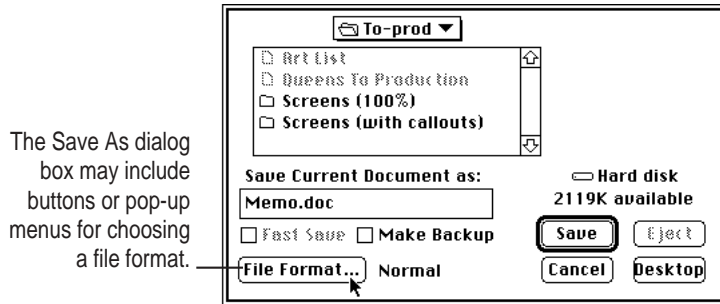

A document's *file format* refers to the way information within the document is encoded. If a program cannot accurately interpret a document's file format, it may display the document incorrectly (as in the figure below).

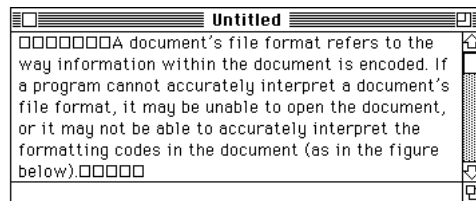

When you save a document that you plan to use with another program, be sure to save it in a file format that the other program can understand. (To find out what file formats a program is able to open, import, and save, see the documentation you received with the program.)

Naming files for use on both Macintosh and DOS computers

On DOS computers, filenames are limited to eight characters (plus a three-letter suffix) and may not contain spaces. The rules for naming Macintosh files are less restrictive. Therefore, when working on the Macintosh, it's possible to give a file a name that would be "illegal" on DOS computers.

For example, suppose you created a file on your Macintosh named
July Budget.DOC

If you viewed the same file on a DOS computer, its name would be
!JULYBUD.DOC

The exclamation mark (!) indicates that the name has been shortened.

A file can thus have two names: a long name (for when the file is displayed on the Macintosh) and a short name (for when it's displayed on a DOS computer).

While using a DOS-format floppy disk on the Macintosh, you can see a document's short name by selecting the document, choosing the Get Info command from the File menu, and clicking the document's name in the Info dialog box. (For this procedure to work, you must have the File Sharing Extension installed.)

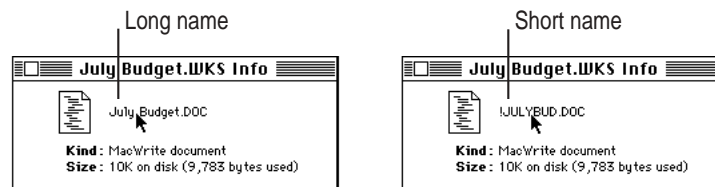

Viewing the contents of a disk on your DOS computer

When you view the directory of a disk on your DOS computer, you might notice additional directories named RESOURCE.FRK. These directories contain important information, known as *resources*, which are contained in some Macintosh documents.

WARNING Do not delete or move any directories named RESOURCE.FRK, and do not move any files out of these directories.

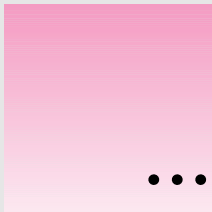

Index

A

- accessories. *See* PowerBook Duo systems
- AC power 59
- active window 20, 30
 - indicating 20, 30, 35
- adapter for floppy disk drive 93
- ADB. *See* Apple Desktop Bus
- airline travel tips 87
- alert messages (File Assistant) 143
- AMI Pro (Windows), exchanging files
 - with 152
- Apple Desktop Bus (ADB)
 - on Duo Dock/Duo Dock II 90
 - on Duo Floppy Adapter 93
 - on Duo MiniDock 92
- Apple HDI-30 SCSI Disk Adapter 104
- Apple HDI-30 SCSI system cable
 - 99, 103
- Apple HD SC Setup
 - installation 129
 - reinstallation 131
- Apple HD SC Setup icon 129
- Apple menu
 - Battery 60
 - Control Panels
 - AutoRemounter options 78
 - Battery Conservation options 71–76
 - for external modem setup 95
 - for hiding Control Strip 51
 - for mouse tracking 85
 - for PC Exchange assignments 155
 - processor cycling options 74–75
 - processor speed feature 75
 - for RAM disk setup 79–80, 81–82
 - for setup as SCSI disk 105
- AppleTalk network
 - automatic sleep and 72, 113
 - delaying printing on 86
 - printer problems on 122–123
- AppleTalk switch, on Control Strip 49, 57–58
- Application menu 40

- application programs
 - assigning to DOS documents 150–159
 - opening DOS documents from 149
 - troubleshooting 125–126
 - arrow keys, selecting items with 40
 - arrow pointer, moving with trackball 10
 - automatic file or folder synchronization 142, 144
 - automatic sleep 8, 61
 - Battery Conservation settings and 72–73
 - problems with 113, 120
 - AutoRemounter options 78
 - in File Assistant 144
- B**
- backup battery 67
 - backup System Folder 128
 - basic skills 31–40
 - batteries. *See also* battery power
 - backup 67
 - caring for 43, 61
 - disposing of 43, 66
 - recharging 43, 62–65
 - problems with 112–113
 - reconditioning 67–70
 - removing or replacing 65–66
 - backup battery 67
 - safety concerns 41, 42, 43, 66
 - troubleshooting 112–113
 - type of 59
 - Battery (Apple menu) 60
 - Battery Conservation settings
 - adjusting 71–73
 - customizing 73–76
 - Battery Conservation slider 71–72
 - Battery desk accessory 60
 - Battery icon 53
 - Battery Monitor module 49
 - customizing 54
 - using 52–53
 - battery power. *See also* batteries
 - AppleTalk and 57
 - conserving 70–71
 - Battery Conservation options 71–76
 - with Battery Monitor 54
 - with power adapter 70
 - with RAM disk 79–84
 - displaying charge level 53, 60
 - Duo MiniDock and 118
 - hard disk spin down and 55
 - low-power messages 61
 - monitoring 59
 - with Battery desk accessory 60
 - with Battery Monitor 52–53
 - problems 112–113
 - problems with 112–113
 - SCSI disk mode and 107
 - sleep mode and 7, 8
 - using while recharging 62, 63
 - battery recharger 63–65
 - Battery Reconditioning icon 68
 - Battery Reconditioning program 67–69
 - blinking icon 115
 - blinking question mark icon 6
 - brightness controls 5
 - adjusting 114
- C**
- cables
 - safety concerns 41
 - for SCSI devices 99, 103–104
 - cache function, on Duo Dock/Duo Dock II 91
 - Cancel button, for starting over 30
 - carpal tunnel syndrome 45
 - chaining SCSI devices 99–104
 - chair, recommendations for 46
 - children, safety concerns with 41
 - .CHP files (Ventura Publisher) 154
 - cleaning the computer 42, 43
 - cleaning the trackball 116

- close box 20
 - on Control Strip 49, 50
 - for starting over 30
 - closing the Control Strip 50
 - closing a document 36
 - clues on screen 29
 - commands
 - choosing from pull-down menus 40
 - dimmed 40
 - selections required for 30
 - connectors, attaching to ports 42
 - contrast controls 5
 - control panels, Control Strip vs. 50
 - Control Panels (Apple menu)
 - AutoRemounter options 78
 - Battery Conservation options 71–76
 - for external modem setup 95
 - for hiding Control Strip 51
 - Mouse control panel 85
 - for PC Exchange assignments 155
 - processor cycling options 74–75
 - processor speed feature 75
 - for RAM disk setup 79–80, 81–82
 - for setup as SCSI disk 105
 - Control Strip 11, 49–58
 - AppleTalk Switch module 57–58
 - Battery Monitor module 52–54
 - closing 50
 - control panels vs. 50
 - File Sharing module 49, 56
 - HD Spin Down module 49, 55
 - hiding 51
 - moving 52
 - opening 50
 - Power Settings module 49, 54
 - rearranging modules in 52
 - resizing 51
 - Sleep Now module 49, 55
 - Sound Volume module 49, 57
 - using 52–58
 - Video Mirroring module 49, 58
 - copying disk contents 38
 - problems with 121
 - copying icons 33
 - correcting errors
 - in typing 22
 - Undo command for 126
 - creating a new document 21–24
 - cumulative trauma disorders (CTDs) 44–45
 - cursor. *See* pointer
 - custom installation dialog box, for system software 134
 - customizing 77–86
 - AutoRemounter options 78
 - Battery Conservation settings 73–76
 - Control Strip 52
 - for delayed printing 86
 - improving pointer display 85
 - RAM disk 79–84
 - system software 133–134
- D**
- Delete key, for typing errors 22
 - Delete Pairs (Edit menu), in File Assistant 140
 - deleting disk contents 39, 121. *See also* Trash
 - desktop 19
 - hiding Control Strip on 51
 - organizing 39
 - desktop Macintosh, synchronizing
 - PowerBook files with 135–144
 - dialog boxes, selecting items in 40
 - dimmed commands 40
 - directories, viewing on DOS
 - computer 161
 - directory dialog boxes, keyboard shortcuts 40
 - Disk First Aid, for system software
 - installation 129
 - reinstallation 131
 - Disk First Aid icon 129
 - disks, opening higher-level 35. *See also* floppy disks; hard disk

- disk space, for system software 132
 - Disk Tools* disk
 - Battery Reconditioning program
 - on 67
 - installing system software from 128–129
 - restarting computer from 110
 - display. *See* monitor, external; screen display
 - .DOC files (Microsoft Word for Windows) 153
 - docking a PowerBook Duo 89–92
 - documents. *See also* files
 - choosing folders for 37
 - creating 21–24
 - creators of 151
 - DOS
 - assigning Macintosh programs to 150–159
 - filename extensions and 151
 - opening 149
 - saving documents onto DOS-format disks 159–161
 - naming 22–23, 37
 - for DOS format 160–161
 - opening and closing 36
 - opening from within programs 36
 - RESOURCE.FRK directories and 161
 - saving and naming 22–23, 37
 - on DOS-format disks 159–161
 - storing inside folders 25–26
 - types of 151, 157
 - working with 36–37
- DOS, exchanging files with 145–161.
See also Windows programs; *specific programs*
- DOS documents
 - assigning Macintosh programs to 150–159
 - filename extensions 151
 - opening 149
 - saving Macintosh documents as 159–161
 - DOS-format disks
 - creating 147–148
 - saving documents onto 159–161
 - using 146
 - editing assignment lists 158
 - naming files for Macintosh or DOS 160–161
 - Quattro files 154
 - RESOURCE.FRK directories and 161
 - sharing assignment lists 159
 - trying out assignments 158
 - viewing disk contents on DOS
 - computer 161
 - WordPerfect files 154
- double-clicking 11
- Duo Dock/Duo Dock II 89–92
 - automatic sleep and 72, 113
 - processor cycling and 74
 - SCSI disk mode and 104
 - SCSI ID numbers and 101
 - troubleshooting 117
 - Duo Floppy Adapter 38, 93
 - Duo MiniDock 92
 - automatic sleep and 113
 - troubleshooting 118
- E**
- Easy Install dialog box
 - for reinstallation 132
 - for system software 130
 - Edit menu, Undo 126
 - Edit menu (File Assistant), Delete Pairs 140
 - ejecting a disk 38
 - problems with 121
 - electromagnetic emissions 48
 - Empty Trash (Special menu) 28
 - entering text, in blank document 22
 - Enter key, selecting items with 40
 - environmental concerns 42, 43
 - Erase Disk (Special menu) 39

- erasing disk contents. *See also* Trash 39
- ergonomics 44–48
 - arranging the work area 46–48
 - eye fatigue prevention 45
 - musculoskeletal discomfort prevention 44–45
- error correction
 - in typing 22
 - Undo command for 126
- error messages, restarting computer after.
See also troubleshooting 8
- Ethernet NuBus card, on Duo Dock/Duo Dock II 90
- EtherTalk port, on Duo Dock II 90
- Excel (Windows version), exchanging files with 153
- expansion options, Duo Dock/Duo Dock II 89–92
- “Extensions off” message 112
- external modem. *See* modem, external
- external monitor. *See* monitor, external
- eye fatigue 45, 48

F

- fatigue, avoiding 45, 48
- File Assistant 135–144
 - alert messages in 143
 - deleting linked files or folders in 140
 - linking files or folders in 136–139
 - starting 136
 - synchronizing linked files or folders in 141–144
- File Assistant Setup window 136, 137
- File menu
 - New Folder 25, 39
 - Open 26, 36
 - for DOS document 149
 - Quit 24
 - for starting over 30
 - Save 22–23, 37
 - for saving to DOS-format disk 159

- Save As 37
 - for choosing a DOS format 160
- File menu (File Assistant), Preferences
 - for linking files or folders with different names 139
 - for turning off alert messages 143
- filenames; filename extensions
 - for DOS documents 151
 - for Macintosh or DOS documents 160–161
- files. *See also* documents
 - linked
 - deleting 140
 - synchronizing 141–142
 - linking 136–139
- File Sharing, on Control Strip 49, 56
- File Sharing Setup control panel 56
- file synchronization, defined 135
- Finder
 - getting to 29
 - keyboard shortcuts in 40
 - selecting items in 40
 - in system software reinstallation 132
- Finder menu bar 29
- flickering screen 114
- floppy disk drive
 - adapter for 93
 - on Duo Dock/Duo Dock II 90
 - problems with 120, 121
- floppy disk drive port
 - on Duo Floppy Adapter 93
 - on Duo MiniDock 92
- floppy disks
 - copying 38
 - DOS-format
 - creating 147–148
 - saving documents onto 159–161
 - using 146
 - ejecting 38
 - erasing contents of 39
 - problems with 120, 121
 - removing items from 34
 - unlocking 125

folders
 choosing for document 37
 creating new 39
 linked
 deleting 140
 synchronizing 141–142
 linking in File Assistant 136–139
 opening 26
 opening higher-level 35
 placing icons inside 39
 storing work inside 25–26, 37
font problems 123
footrest 46

G

ghost images 114
grounding plug 2

H

hard disk
 copying to floppy disk from 38
 copying from floppy disk to 38
 Disk First Aid check of 129
 installing system software on
 128–134
 problems with 110, 120
 removing an item from 34
 saving a new document to 22–23
 sleep mode and 72
 spinning down 55
 using PowerBook as 104–107
hard disk icon 12, 19
HD Spin Down, on Control Strip 49, 55
headphones
 connecting 97
 ports for 90, 92
 sound input port warning 97
health-related concerns 44–48
Help menu 40
 Show Balloons, for Control Strip 49
hiding the Control Strip 51

I, J

I-beam pointer, thickening 85
icons 19
 blinking 115
 copying 33
 defined 32
 moving 33
 naming 33
 placing inside folders 39
 selecting and deselecting 32
 working with 32–34
ID numbers, for SCSI devices 100–101
initializing a DOS-format disk 147–148
Installer program 128, 129–130
installing SCSI drivers 100
installing system software
 customized version 133–134
 for the first time 128–130
 reinstallation 111, 131–133
Install Me First disk, Installer program
 on 128

K

keyboard
 adjusting height of 47
 positioning 46
 repetitive stress injuries from 45
keyboard shortcuts, in Finder and
 directory dialog boxes 40

L

lighting, eye fatigue and 45
lightning bolt icon 60
linking files or folders 136–139
 deleting linked pairs 140
 non-matching 139
Lotus 1-2-3 (Windows), exchanging files
 with 152
low-power messages 61

M

- Macintosh Basics screen 14
- Macintosh Basics* tour
 - beginning 10–14
 - opening screen 13
 - practice session 21–30
 - review questions 15–20
- Macintosh HD icon 12
- Macintosh HD screen 13
- Macintosh PC Exchange software 145.
 - See* DOS, exchanging files with
- maintenance
 - cleaning the computer 42, 43
 - cleaning the trackball 116
 - service and support 88
- manual file or folder synchronization 142
- math coprocessor (FPU), on Duo Dock/Duo Dock II 90
- memory
 - adding to computer 97
 - insufficient 116
 - application problems and 125, 126
 - RAM disk requirement 79
 - virtual 97
 - power conservation and 70
 - unavailable 116
- Memory control panel 80
 - power conservation and 70
 - setting up RAM disk with 79–80, 81–82
- menus, pull-down, working with 40
- microphone, connecting 97
- microprocessor, power conservation by 74–75
- Microsoft Excel for Windows,
 - exchanging files with 153
- Microsoft Word for Windows,
 - exchanging files with 153
- MiniDock 92
 - automatic sleep and 113
 - troubleshooting 118
- modem
 - power conservation and 71
 - troubleshooting 122
- modem, external
 - connecting to Duo system 94–95
 - problems with 122
- modem port
 - on Duo Dock/Duo Dock II 90
 - on Duo MiniDock 92
- Modem port icon 94
- modules, in Control Strip 49
 - rearranging 52
- monitor, external. *See also* screen display
 - adjusting for comfort 48
 - Duo Dock/Duo Dock II and 90, 91
 - Duo MiniDock problems 118
 - electromagnetic emissions from 48
 - MiniDock and 92
 - PowerBook Display control panel for 98
 - using for presentations 98
 - Video Mirroring module for 58, 98
- monitor port, on Duo Dock/Duo Dock II 90
- mouse
 - positioning for 47
 - setting for tracking 85
- Mouse control panel 85
- moving the computer, warnings about 42
- moving the Control Strip 52
- moving icons 33
- moving windows 27
- musculoskeletal discomfort 44–45

N

- naming a document 22–23, 37
 - for Macintosh or DOS use 160–161
- naming a folder 25
- naming icons 33
- network
 - automatic sleep and 72
 - AutoRemounter feature 78
 - connecting printer on 96
 - delaying printing on 86
 - installing system software from 128, 130
 - troubleshooting 124
 - printer problems 122–123
- new document
 - creating 21–24
 - saving and naming 22–23, 37
- new folder, creating 39
- New Folder (File menu) 25, 39
- new folder icon 25
- NuBus card slots, on Duo Dock/Duo Dock II 90

O

- Open (File menu) 26, 36
 - for DOS document 149
- opening the Control Strip 50
- opening the display 3
- opening a document 36
 - from within a program 36
- opening a folder 26
- opening icons 33
- organizing the desktop 39

P

- PageMaker (Windows), exchanging files with 153
- password, shared disk reconnection and 78
- PC Exchange 145. *See also* DOS, exchanging files with
- PC Exchange control panel 155
- PC Exchange Preferences file 159
- plug adapters 87
- plugging in the PowerBook Duo 1–2
- .PM4 files (PageMaker) 153
- pointer
 - adjusting tracking speed of 114
 - frozen 115
 - improving display of 85
 - moving with trackball 10
- ports, connecting cables or adapters to 42
- power adapter 1–2, 42
 - battery icon and 53
 - for battery recharger 63
 - RAM disk and 84
 - recharge indicator 60
 - recharging the computer with 62
 - travel adapters for 87
- power adapter port 2
- PowerBook control panel. *See* Control Panels (Apple menu)
- PowerBook Duo 230
 - processor speed feature 75
 - reconditioning battery in 70
- PowerBook Duo 280
 - reconditioning battery in 67–69
 - sleep mode indicator on 72
- PowerBook Duo 280c
 - reconditioning battery in 67–69
 - sleep mode indicator on 8, 55, 72

- PowerBook Duo systems 89–93. *See also specific systems*
 - adding memory to 97
 - adding SCSI devices to 99–104
 - connecting a modem to 94–95
 - connecting a printer to 96
 - connecting sound input/output devices to 97
 - Duo Dock/Duo Dock II 89–91
 - Floppy Adapter 93
 - MiniDock 92
 - using for presentations 98
 - PowerBook File Assistant 135–144
 - alert messages in 143
 - deleting linked files or folders in 140
 - linking files or folders in 136–139
 - starting 136
 - synchronizing linked files or folders in 141–142
 - PowerBook File Assistant icon 136
 - PowerBook HD icon 12
 - PowerBook Setup control panel
 - for external modem 95
 - for SCSI disk setup 105
 - power button 5
 - losing unsaved work with 7
 - power conservation settings, changing 54, 76
 - power management 59–76. *See also* batteries; battery power
 - Control Strip for 49, 54
 - low-power messages 61
 - maximizing work time 70–76
 - SCSI disk mode and 107
 - troubleshooting 112–113
 - Power On key 4
 - no response from 5
 - Power Settings, on Control Strip 49, 54
 - changing 54, 76
 - power sources 59
 - conservation settings and 76
 - practice session 21–30
 - Preferences (File menu), in File Assistant
 - for linking files or folders with different names 139
 - for turning off alert messages 143
 - printer
 - connecting 96
 - troubleshooting 122–123
 - Printer/modem port icon 94
 - printer port 96
 - on Duo Dock/Duo Dock II 90
 - on Duo MiniDock 92
 - Printer port icon 96
 - printing, deferring until later 86
 - processor cycling 74–75
 - programs slowed by 125
 - processor speed feature 75
 - program, checking where you are 29
 - pull-down menus, working with 40
- Q**
- Quattro, exchanging files with 154
 - question mark icon, system software warning 6, 127
 - quick reference information 31–40
 - Quit (File menu) 24
 - for starting over 30
 - quitting a program 24
 - quitting SCSI disk mode 108
 - quiz on basics 15–18
- R**
- radio and television interference, vii
 - RAM, adding to computer 97
 - RAM cache function, on Duo Dock/Duo Dock II 91
 - RAM contents
 - backup battery and 67
 - low power and 61
 - system sleep and 72

- RAM disk
 - persistent 79
 - for power conservation 70
 - Restart command and 8
 - setting up 79–83
 - shutting down and 80
 - as startup disk 81–83
 - using 84
 - recharging the battery 42, 43, 62–65
 - problems with 112–113
 - reconditioning the battery 67–69
 - recycling batteries 66
 - reinstalling system software 111, 131–133
 - removing items from disk 34
 - removing or replacing batteries 65–66, 67
 - repetitive stress injuries (RSIs) 44–45
 - repositioning. *See entries beginning with moving*
 - resizing the Control Strip 51
 - RESOURCE.FRK directories 161
 - Restart button 8
 - restarting the computer 8, 30
 - problems with 110–111
 - for temporary “crash” 111
 - Restart (Special menu) 8, 30
 - Return key, selecting items with 40
 - review of basics 15–18
 - RSIs (repetitive stress injuries) 44–45
- S**
- safety considerations 41–43
 - battery leakage 66
 - children and 41
 - grounding plug 2
 - .SAM documents (AMI Pro) 152
 - Save (File menu) 22–23, 37
 - for saving to DOS-format disk 159
 - Save As (File menu) 37
 - for choosing a DOS format 160
 - saving and naming documents 22–23, 37
 - disk problems 121
 - screen display. *See also monitor, external*
 - adjusting for comfort 3, 47
 - brightness and contrast controls 5
 - cleaning 43, 48
 - closing, for sleep mode 7
 - electromagnetic emissions from 48
 - lifting and adjusting 3
 - low-power messages and 61
 - organizing desktop 39
 - power conservation and 70, 71, 72
 - problems with 114–115
 - startup 4
 - scroll arrows 20
 - on Control Strip 49
 - scroll bar 20
 - scrolling through a window 34
 - SCSI devices 99–108
 - battery power and 107
 - connecting 99–104
 - defined 99
 - disconnecting PowerBook from 108
 - terminators for 102
 - troubleshooting 119
 - using PowerBook as 104–107
 - SCSI disk mode
 - battery power and 107
 - quitting 108
 - using PowerBook in 104–107
 - SCSI drivers, installing 100
 - SCSI hard disk drive, on Duo Dock/Duo Dock II 90
 - SCSI icon 106
 - SCSI ID numbers, setting 100–101
 - SCSI port 99
 - on Duo Dock/Duo Dock II 90
 - on Duo MiniDock 92
 - SCSI port icon 99
 - selected icons, commands and 30
 - selecting icons 32
 - selecting items, keyboard shortcuts for 40
 - serial port
 - automatic sleep and 72

- connecting printer to 96
- service and support 88
- setting up the PowerBook Duo 1–6
- setting up your work area 45
- shared disk
 - automatic reconnection to 78
 - automatic sleep and 72
 - automatic synchronization on 144
 - problems with 124
- Show Balloons (Help menu), for Control Strip 49
- Shut Down (Special menu) 7
 - RAM disk and 80
 - for storing the computer 88
- SimpleText icon 21
- SimpleText program
 - opening 21
 - quitting 24
- size box 20
- Sleep (Special menu) 7
- sleep mode
 - automatic 8, 61
 - Battery Conservation settings and 72–73
 - problems with 113, 120
 - AutoRemounter feature and 78
 - entering 7–8, 56, 60
 - from Battery desk accessory 60
 - from Control Strip 55–56
 - moving the computer in 42
 - problems with 113
 - RAM disk and 84
 - recharging battery in 65
 - shutting down from 7
 - waking up from 8, 56
- Sleep Now, on Control Strip 49, 55
- Small Computer System Interface (SCSI)
 - 99. *See also entries beginning with SCSI*
- software. *See also* application programs; system software
 - incompatibility problems 112
 - installing SCSI drivers 100

- sound input/output
 - connecting devices for 97
 - on Duo Dock/Duo Dock II 90
 - on Duo MiniDock 92
 - Sound Volume, on Control Strip 49, 57
 - speakers
 - connecting 97
 - ports for 90, 92
 - Special menu
 - Empty Trash 28
 - Erase Disk 39
 - Restart 8, 30
 - Shut Down 7
 - RAM disk and 80
 - for storing the computer 88
 - Sleep 7
 - spills, warning about 42
 - starting over 30
 - starting up
 - problems 5–6, 110, 120
 - setting up RAM disk for 81–83
 - turning on the computer 4
 - startup disk, defined 127
 - Storage folder, System Folder and 133
 - storing documents in folders 25–26
 - storing the PowerBook 88
 - stress, avoiding 44–48
 - summary of basics 31–40
 - support sources 88
 - Synchronize menu 138
 - synchronizing files or folders 141–142
 - linking for 136–139
 - system error, restarting computer after 8
 - System Folder
 - backing up 128
 - copying to RAM disk 81
 - more than one, problems from 111
 - PC Exchange Preferences file in 159
 - Storage folder and 133
 - system sleep. *See* sleep mode
 - system software
 - battery problems and 113
 - defined 127
 - installing
 - customized version 133–134
 - for the first time 128–130
 - as reinstallation 111, 131–133
 - in multiple folders 111
 - requirement for 6, 127
- T**
- tab, on Control Strip 49, 50, 51
 - Tab key, selecting items with 40
 - telecommunications, internal vs. external
 - modem for 95
 - television interference, vii
 - terminators, SCSI 102
 - text, entering in blank document 22
 - throwing items away. *See* Trash
 - title bar 20
 - token ring NuBus card, on Duo
 - Dock/Duo Dock II 90
 - tour, *Macintosh Basics* 10–14
 - trackball
 - double-clicking 11
 - problems with 116
 - settings 85
 - using 10
 - tracking speed, adjusting 114
 - transporting the computer
 - environmental concerns 42
 - travel tips 87
 - Trash
 - retrieving items from 34
 - role of 20
 - throwing items into 27–28
 - Trash icon 27
 - traveling with the PowerBook 87

- troubleshooting 109–126
 - application programs 125–126
 - computer stops working 111
 - disk drives and disks 120–121
 - Duo Dock/Duo Dock II 117
 - Duo MiniDock 118
 - memory problems 116
 - modem problems 122
 - network problems 122–123, 124
 - odd behavior 111–112
 - power problems 112–113
 - printer problems 122–123
 - restart problems 110–111
 - screen problems 114–115
 - SCSI devices 119
 - starting over 30
 - startup problems 5–6, 110, 120
 - trackball problems 116
 - viruses 112
 - warranty concerns 42, 109
- turning on the PowerBook Duo 4
 - problems with 5–6
- turning off the PowerBook Duo 7
- tutorial 9–30
 - Macintosh Basics* tour 10–14
 - practice session 21–30
 - review questions 15–20
- typing, avoiding pain from 46, 47
- typing text 22

U

- Undo command (Edit menu) 126
- untitled folder icon 25
- upgrading memory 97

V

- Ventura Publisher, exchanging files
 - with 154
- Video Mirroring module 49, 58
- video mirroring, turning on or off
 - with Control Strip 58
 - with PowerBook Display control panel 98
- video support, on Duo Dock/Duo Dock II 91
- viewing window contents 34, 35
- virtual memory 97
 - power conservation and 70
 - unavailable 116
- viruses 112
- VRAM, on Duo Dock/Duo Dock II 91

W

- waking the computer 8, 56
- wall mount plug 2
- warranty concerns 42, 109
- windows
 - active 20, 30, 35
 - disappearing 115
 - moving 27
 - opening 34
 - viewing contents of 34, 35
 - working with 34–35
- Windows programs, exchanging files
 - with 145–161
 - AMI Pro 152
 - Lotus 1-2-3 152
 - Microsoft Excel 153
 - Microsoft Word 153
 - PageMaker 153
 - Ventura Publisher 154

The Apple Publishing System

This Apple manual was written, edited, and produced on a desktop publishing system using Apple Macintosh computers and QuarkXPress. Technical illustrations were drawn in Adobe™ Illustrator; screen shots were created and modified with system software, Exposure Pro, Aldus SuperPaint, and Adobe Photoshop. Proof pages were created on Apple LaserWriter printers and on QMS and Tektronix color printers. Final pages were output directly to separated film on a PostScript™-driven imagesetter.

Text type is Times®, display type is Helvetica® Narrow, and cover type is Apple Garamond, Apple's corporate font. Ornaments are custom symbols designed for Apple Computer.

PostScript, the LaserWriter page-description language, was developed by Adobe Systems Incorporated.