

Follow the instructions in this chapter to set up your computer.



1

Getting Started



The illustration on the next page provides an overview of your Macintosh PowerBook computer. To set up your computer for the first time, you need the power adapter and the power cord that came with it.

When setting up your computer, place your computer on a sturdy, flat surface near a grounded electrical outlet. Before following the setup instructions in this chapter, you may want to read “Arranging Your Work Area and Equipment” in Appendix A for tips on adjusting your work furniture and computer so that you’re comfortable when using the computer.

When you’ve determined where to put the computer and reviewed the information about arranging your work area and the illustration of the PowerBook, turn to “Opening the Display” to begin the setup procedure.

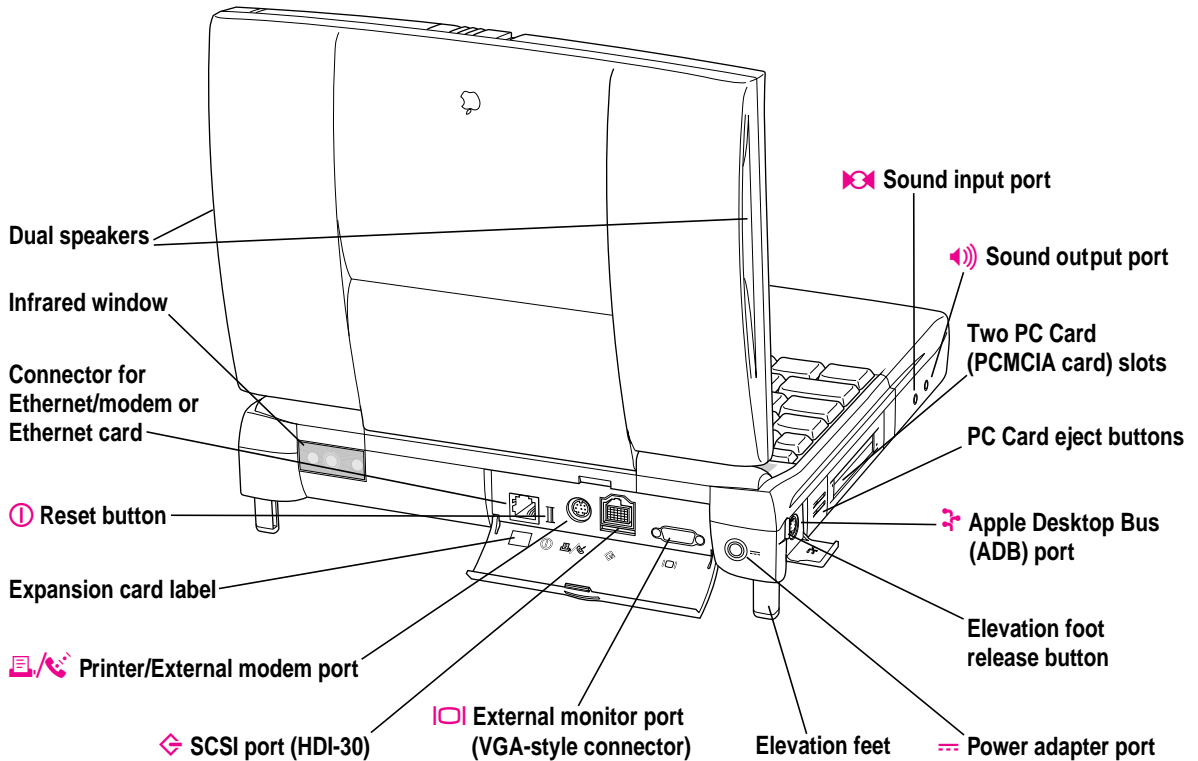
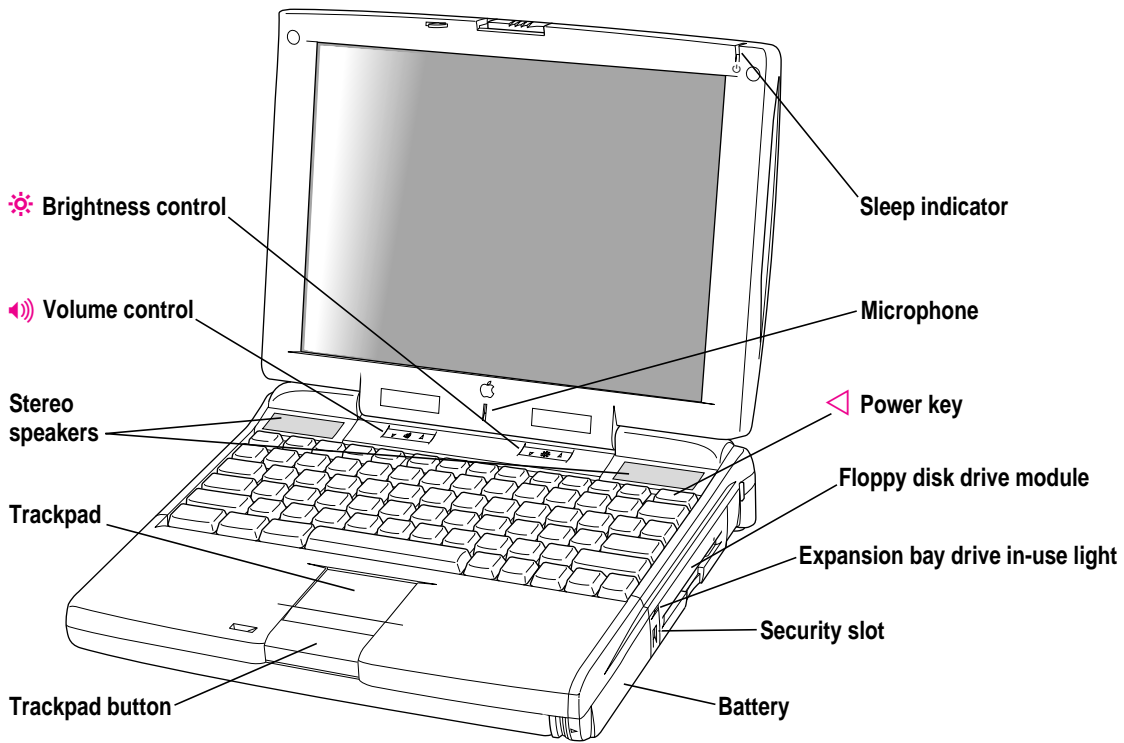

Opening the display

- 1 Slide the latch to the left and lift up the display.

Slide the latch to the left to open the display.

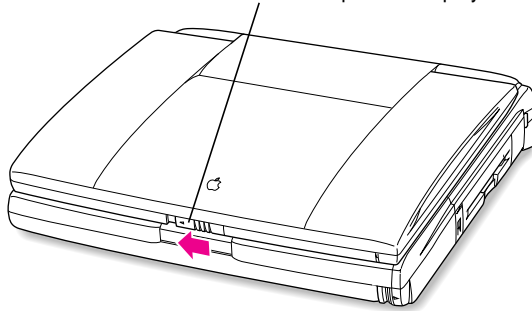

- 2 Position the display at a comfortable viewing angle.

You can adjust the angle of the display at any time by tilting it toward or away from you.

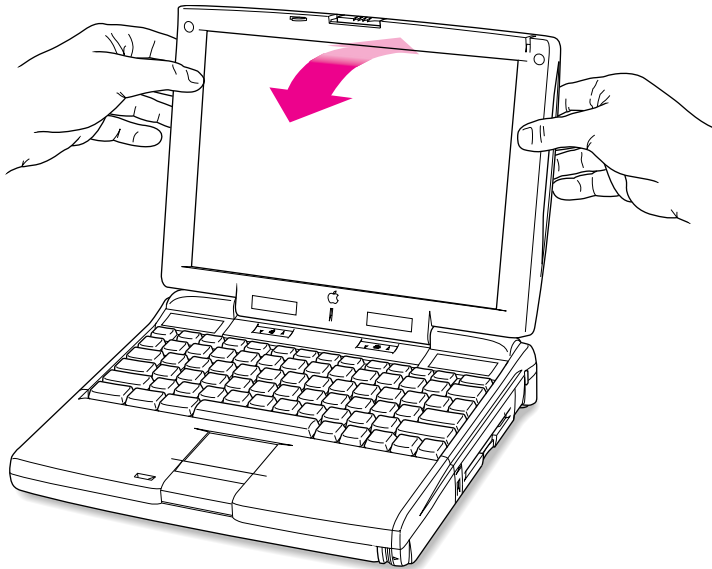

3 Adjust the elevation feet to raise the computer.

The back of the keyboard is slightly elevated when the feet are in use.

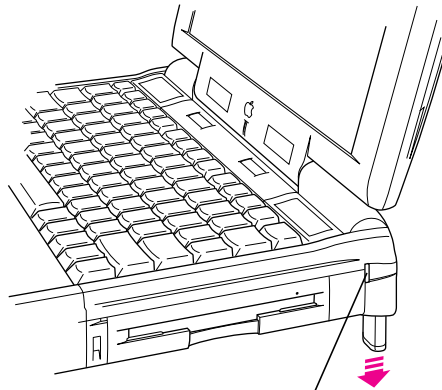

To lower the foot, press the release button. The foot extends automatically.

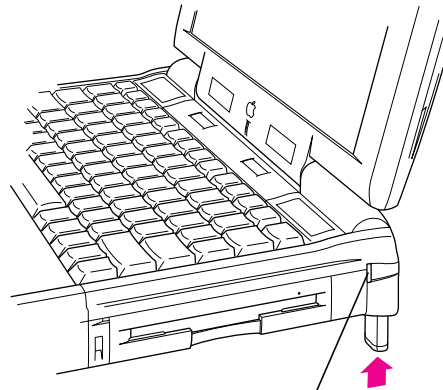

To raise the foot, press the release button while pushing up on the foot until it clicks into place.

It is a good idea to lower the elevation feet whenever you are using your computer on a flat surface.

Removing the battery's paper wrapper

Most new PowerBooks are shipped with a paper wrapper covering the battery to protect it from losing its charge completely. If there is a wrapper, you need to remove it before the battery will provide power for the computer.

- 1 With the display open, peel off the part of the label on the computer's case, taking care not to tear the wrapper.**
- 2 Close the display (with the detached part of the wrapper outside of the computer).**

- 3 Press the battery release button on the battery.

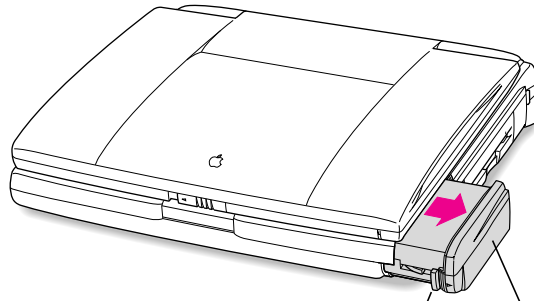

1 Press the button on the battery. 2 Slide the battery out.

- 4 Slide the battery out of its compartment.
- 5 Carefully remove the wrapper from the battery.

Avoid touching the battery's metal contacts as you peel off the wrapper.

- 6 Replace the battery and open the display.

After removing the wrapper, you can save it for reuse or throw it away.

Plugging in the computer

Plugging in the power adapter recharges the computer's battery. You should plug in the power adapter in case the battery has drained during shipping or storage. (If the battery was completely drained, the power will come on automatically when the power adapter is attached.)

WARNING Use only the power adapter that came with your Macintosh PowerBook computer, part number M4895 (or an adapter from another manufacturer that is designed specifically for your PowerBook model). Adapters for other electronic devices (including other Macintosh PowerBook models and other portable computers) may look similar, but they may damage your computer.

- 1 Plug one end of the power cord into the power adapter and the other end into a three-hole grounded outlet or power strip.

WARNING This equipment is intended to be electrically grounded. The power adapter that came with your Macintosh PowerBook is equipped with a three-wire grounding plug—a plug that has a third (grounding) pin. This plug will fit only a grounded AC outlet. This is a safety feature. If you are unable to insert the plug into the outlet, contact a licensed electrician to replace the outlet with a properly grounded outlet. Do not defeat the purpose of the grounding plug!

- 2 Plug the power adapter plug into the power adapter port (marked with the icon ) on the back panel of the computer.

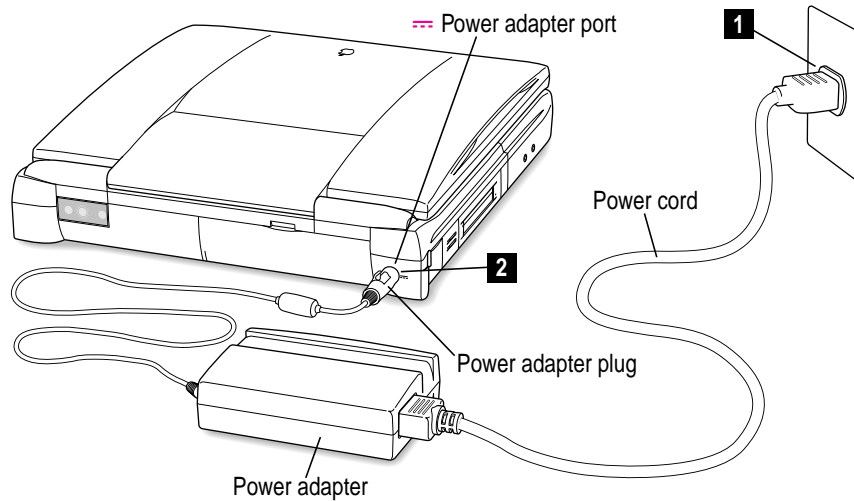

Turning the computer on

To turn on the computer for the first time and prepare it to record any settings you establish, follow these steps.

- 1 Press the Power key at the upper-right corner of the keyboard to turn the computer on.**

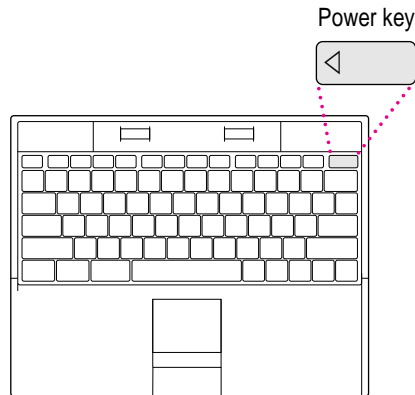

You should hear a tone when you turn on the computer. It takes the computer a few moments to start up.

As the computer starts up, several messages appear on the screen.

- 2 To be certain that the computer saves any new settings you establish as you work with it, press and hold the Power key for 2 seconds.**

A message appears, asking whether you want to shut down the computer.

- 3 In the message on the screen, click Restart.**

To click Restart, move your finger on the trackpad to move the arrow on the screen until the tip of the pointer is on Restart and press the trackpad button once.

The computer turns off briefly, then starts up again.

Note: You only need to use this restart procedure the first time you turn on the computer or after the battery has been completely discharged or has been out of the computer for three days or more.

After the computer has started up for the second time, go to the section “What’s Next?” for more instructions, or finish reading this chapter to learn how to turn the computer off and put it to sleep.

If the computer does not start up, go to the next section, “Problems Turning the Computer On?”

Problems turning the computer on?

- **Nothing happened when you pressed the Power key.**

The battery may be drained. Make sure you plugged in the power adapter, and that the power adapter is firmly connected to both the computer and a power source. If the power adapter is plugged into a power strip, make sure the power strip is plugged in and turned on. If the computer doesn’t make a sound when you press the Power key, press the reset button (marked with an Ⓢ) on the back of the computer. Once the battery has charged you should be able to use the Power key normally.

If the computer still doesn’t turn on, see “Problems Starting Up the Computer” in Chapter 5.

- **The computer made a sound, but you can’t see anything on the screen.**

Adjust the brightness control (marked with the icon ☼) until an image appears and the screen is easy to read.

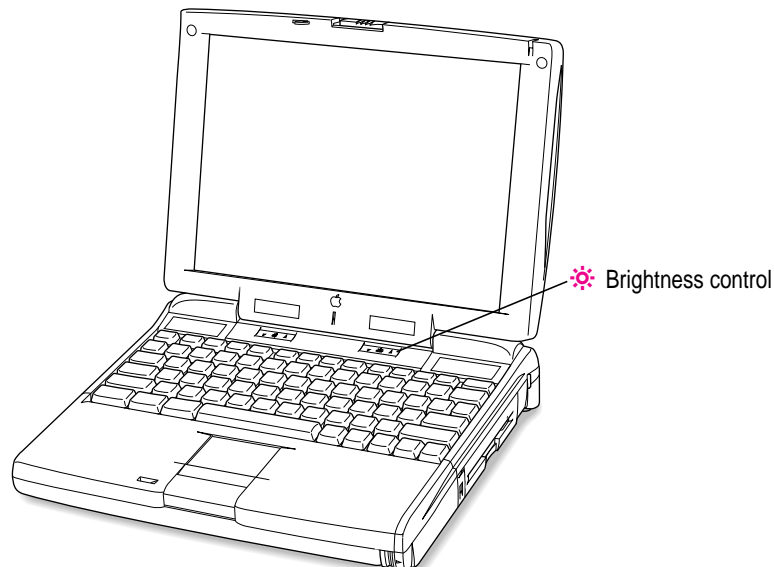

- You see a picture of a disk with a blinking question mark on the screen.



This icon usually means that the computer can't find system software on the hard disk or any disks attached to the computer. You may need to reinstall system software. See “Reinstalling System Software” in Chapter 6.

Turning the computer off

Always use one of the following methods to shut down the computer. If you don't, you risk losing any work you haven't previously saved on a disk. You also risk losing any open documents.

Turning the computer off with the Power key

To turn the computer off, press the Power key. Detailed instructions follow.

- 1 If the computer is in sleep, press the Power key (or any key on the keyboard except Caps Lock) to wake it.

For information on the sleep feature of your Macintosh PowerBook, see “Putting the Computer to Sleep,” next.

- 2 Press and hold the Power key for about two seconds.

The following dialog box appears on the screen:

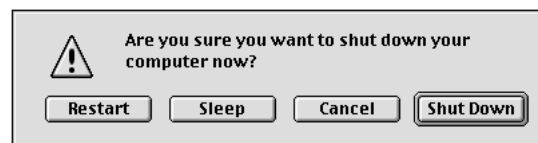

- 3 Press the Return key on the keyboard (or click the Shut Down button in the dialog box).

Turning the computer off with the Shut Down command

You can also turn your computer off by using the Shut Down command in the Special menu. Follow these steps:

- 1** If the computer is in sleep, press the Power key (or any key on the keyboard except Caps Lock) to wake it.
- 2** Move the tip of the arrow to the word “Special” at the top center of the screen.

If the word “Special” does not appear at the top of the screen, you’re not working in the Finder. Choose Finder from the Application menu at the far-right end of the menu bar.
- 3** With the tip of the arrow on the word “Special,” press and hold down the trackpad button.
- 4** While holding down the trackpad button, move the arrow until the words “Shut Down” are highlighted, then release the button.

Trouble? If a problem with the computer prevents you from using the Power key or choosing Shut Down—for example, if the computer “freezes” so that the pointer does not respond to the trackpad—you can restart the computer by pressing the Command (⌘), Control, and Power keys simultaneously. If the computer doesn’t restart, press the reset button (marked with an Ⓢ) on the back of the computer. Use this method only if you cannot choose Shut Down or Restart when you press the Power key, or if you cannot choose either command from the Special menu.

Putting the computer to sleep

Sleep is a power conservation feature of Macintosh PowerBook computers that lets you instantly restart the computer and bypass the startup process. You can extend the period of time your battery will power the computer by putting the PowerBook to sleep when you won’t be using it for several minutes or hours. The length of time the computer can be left in sleep depends on the charge state of the battery.

When the computer is in sleep, it has a darkened screen and appears to be off. A small green light flashes on the top of the display case when the computer is in sleep. (*Note:* The computer must be on in order for you to put it to sleep.)

To put the computer to sleep, do this:

- 1 Press and hold the Power key for about two seconds.
- 2 Click the Sleep button.

WARNING Once you put your computer to sleep, listen for the hard disk to stop spinning before you move your Macintosh PowerBook. Moving your Macintosh PowerBook with the hard disk spinning can damage your computer.

Other ways of putting your computer to sleep

- You can choose the Sleep command from the Special menu to put your computer to sleep.
- You can also put your computer to sleep by closing and latching the display. When the computer is in sleep, a small green light flashes in the upper-right corner of the display.

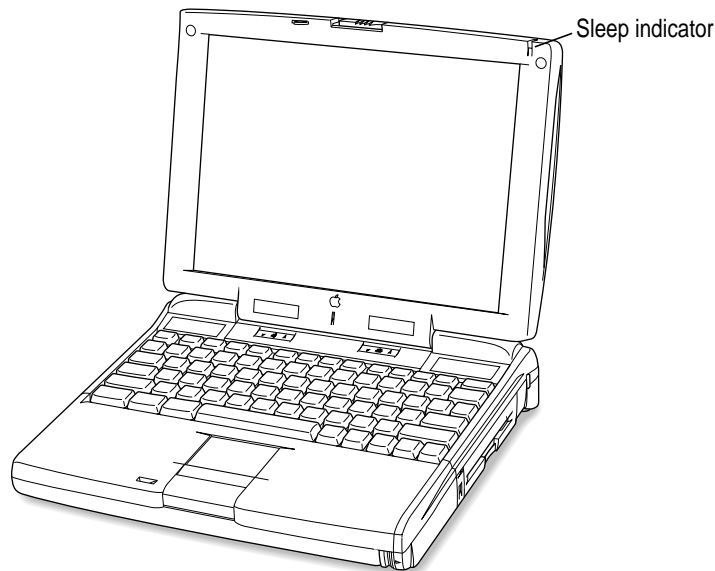

For information on other ways of putting the computer to sleep, see Mac OS Help, available in the Help menu. (See “What’s Next?” later in the chapter for more information about using Mac OS Help.)

Automatic sleep

If you don't use the computer for several minutes, it goes to sleep automatically. This conserves battery power.

To wake the computer, press any key on the keyboard (except Caps Lock). The screen will reappear as it was before the computer went to sleep.

You can control the automatic sleep feature. For more information on sleep and automatic sleep, see Mac OS Help.

Restarting a computer that's already on

You need to restart your computer—turn it off and back on again—when you want to make certain changes to settings, use a newly installed system software file, or start up the computer using a different disk.

You may also need to restart if you see a “system error” message on the screen (indicating a temporary software problem). In this case, use the trackpad to click the Restart button that appears.

Follow these instructions to restart your computer:

- 1 Press and hold the Power key for about two seconds.**
- 2 Click the Restart button.**

You can also do this to restart:

- **Choose Restart from the Special menu.**

If the Special menu does not appear in the menu bar, you're not working in the Finder. Click anywhere on the desktop to return to the Finder.

When you choose Restart, the computer prompts you to save your work, closes all open programs, and restarts itself.

Restarting using either of the methods outlined above does not affect your RAM disk (if you created one) or its contents.

Trouble? If a problem with the computer prevents you from using the Power key or choosing Restart—for example, if the computer “freezes” so that the pointer does not respond to the trackpad—you can restart the computer by pressing the Command (⌘), Control, and Power keys simultaneously.

If the computer doesn’t restart, press the reset button (marked with an ⓪) on the back of the computer. (If the computer is on but “frozen,” pressing the reset button will turn off the computer. You will then need to press the Power key to turn it on.) Use this method only if you cannot choose Shut Down or Restart from the dialog box that appears when you press the Power key, or if you cannot choose either command from the Special menu.

What’s next?

You’ve now finished setting up your Macintosh PowerBook. Continue with one of the following steps:

- If you are new to the Macintosh, use the online information provided on your PowerBook to learn more about using your computer.

To begin, use the Mac OS Setup Assistant that automatically opens on your screen to enter some basic information, such as your name and organization, the date, time, and time zone, and your preference for a simplified interface or the standard Mac OS interface. To advance through the Setup Assistant, click the forward or back arrow in the lower-right part of the window. (Move your finger on the trackpad to move the arrow on the screen until the tip of the pointer is on the forward or back arrow and press the trackpad button once.) You can leave Mac OS Setup Assistant any time by clicking the close box (at the upper-left corner of the window) and clicking Quit in the message that appears.

After you’ve used the Mac OS Setup Assistant, locate the Help menu at the top of the screen. (Move your finger on the trackpad to move the arrow on the screen until the tip of the pointer is on “Help.” Press and hold down the trackpad button and move the arrow downward until the word “Help” is highlighted, then release the trackpad button). When the Mac OS Help window opens, move the arrow to “Learning the Basics” at the top of the list of topics. Then move the arrow to “OK” at the bottom right of the window and press the trackpad button once.

- If you are an experienced Macintosh user, complete the information in the Mac OS Setup Assistant and explore the Mac OS Info Center on your computer's hard disk to learn about your PowerBook's features and the software provided with your system. Also look at the online instructions in the Help menu.
- If you have additional equipment for your computer, see Chapter 2, "Using Expansion Bay Modules and PC Cards," and Chapter 3, "Connecting Additional Equipment," for instructions. (If you are a new Macintosh user, you should complete "Learning the Basics" in Mac OS Help before connecting additional equipment.)

2

Using Expansion Bay Modules and PC Cards



Using expansion bay modules

The floppy disk drive and the CD-ROM drive for your Macintosh PowerBook are removable modules, which you can easily switch or replace with another module. The place in your computer where modules go is called the *expansion bay*. (The floppy disk drive is installed in the expansion bay at the factory.)

You can switch the modules, such as the floppy disk drive, CD-ROM drive or PC Card storage case, or remove a module while the PowerBook is turned on, in sleep, or shut down. All expansion bay modules are inserted and removed in the same way.

To protect your work and to be sure that the computer recognizes which module is in use, first quit any programs that may be using files on the disk in that module. Then select the disk's icon and choose Put Away from the File menu or drag the icon to the Trash.

IMPORTANT Don't switch modules while the computer is starting up. Also take care not to remove a module if a floppy disk or CD-ROM disc is inserted and in use.

If you purchase an expansion bay module from an independent supplier, be sure to follow the instructions that came with the device. Some modules may have special requirements, such as shutting down the computer before inserting or removing the module. At least one manufacturer makes an internal power adapter for use in the expansion bay.

Removing an expansion bay module

To remove an expansion bay module from your Macintosh PowerBook, follow these steps:

- 1** Quit any application programs or files that are using the floppy disk or compact disc (CD) or other medium inserted in the expansion bay module.

Remember to save your work.

- 2** If a floppy disk or CD is inserted in the module, click its icon to select it and drag its icon to the Trash (or choose Put Away from the File menu).

You should not remove the module if a disk is in use. If you have any other kind of optional expansion bay module, make sure you drag the icon for its media to the Trash or select the icon and choose Put Away from the File menu.

- 3** Unlock the expansion bay module by sliding the module release latch on the bottom of your Macintosh PowerBook in the direction of the arrow.

To unlock the module, slide the latch on the underside of the computer.

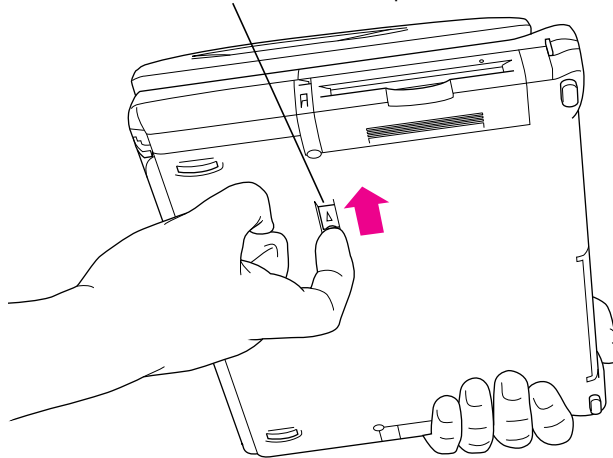

4 Hold the module by the gripping surface and pull it out of the computer.

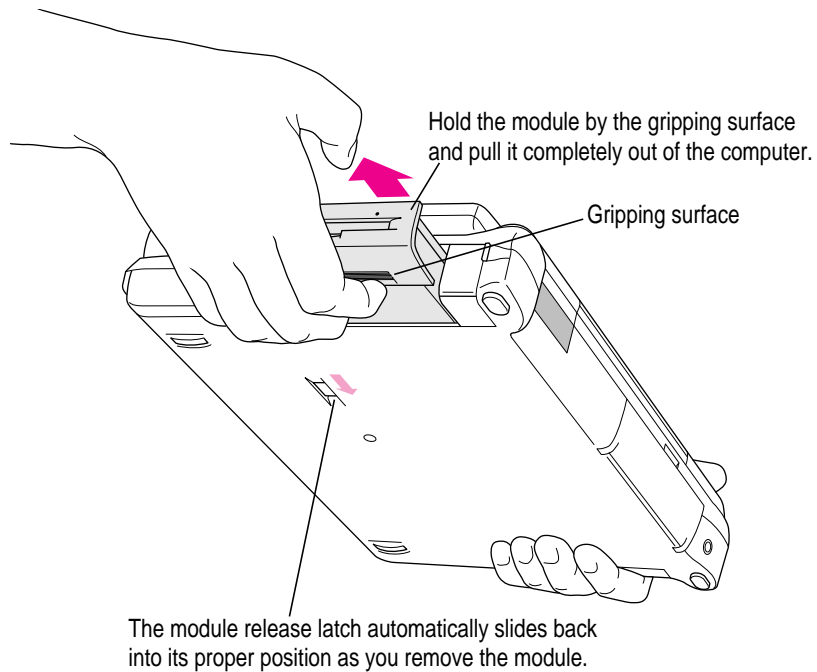

IMPORTANT You should not remove an expansion bay module if it is in use or you may lose data. If you try to remove the module when it is in use, you'll see a message telling you to reinsert it. Reinsert the module, quit any files or programs that may be using the floppy disk (or other medium inserted in the module), then select the disk's icon and choose Put Away from the File menu or drag the disk's icon to the Trash. (If the module contains the startup disk, you can't remove the module or drag the disk to the Trash.)

To be sure that you don't get another in-use message, wait 5 seconds after quitting programs and ejecting a disk before you remove the module.

If you put your computer to sleep while a floppy disk or other medium is inserted, the green in-use light to the left of the module will flash (similar to the sleep indicator light on your computer's display). You should not remove the module while the in-use light is on or flashing.

Inserting an expansion bay module

To reinsert the expansion bay module, slide the module in. Make sure the gripping surface is facing down. The release button automatically returns to the locked position.

Be sure the module is completely inserted. If it does not insert properly, reset the module release latch to the unlocked position (as in step 3 earlier) before reinserting the module.

The expansion bay can use a wide component, such as the 5.25-inch CD-ROM drive, or a narrower component, such as the 3.5-inch floppy disk drive. When a narrower device is in the expansion bay, a small flap covers the empty part of the bay. When a wider drive is inserted, the flap folds into the bay.

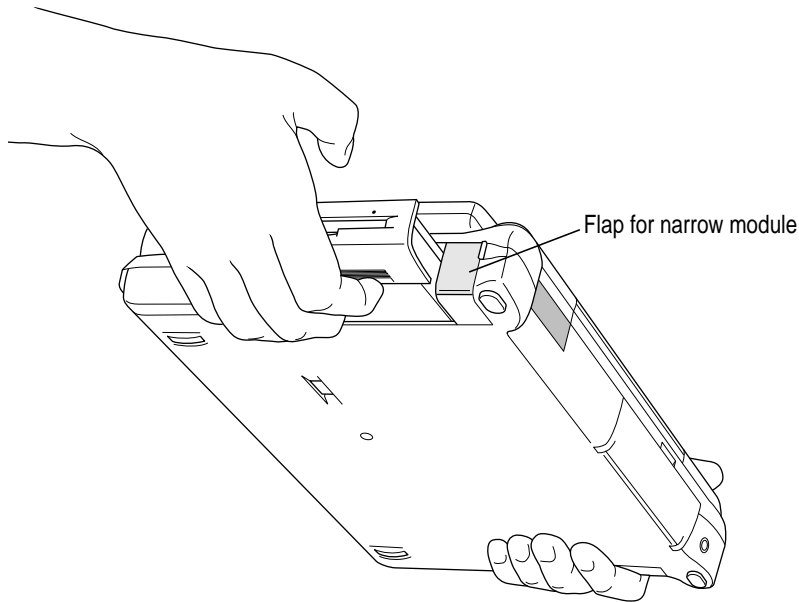

Note: A plastic storage case for PC Cards is provided with your PowerBook. This case fits into the expansion bay. If you want to make the computer as light as possible, you can remove the module in the expansion bay and insert the PC Card storage case. Always keep a module or the PC Card storage case in the expansion bay to protect the connectors inside the bay.

Using a CD in the CD-ROM drive

You insert or remove the CD-ROM drive in the same way as any other module.

Inserting a disc

To load a compact disc in the drive, follow these steps:

- 1 Start up the PowerBook, if it's not already on.**
- 2 Press the Open button on the outside of the CD-ROM module to open its tray.**

The tray opens part way.

(If the tray doesn't open, a disc may already be in the drive. Drag its icon to the Trash to open the tray. You'll see a message if the disc is in use; in that case, quit the program in use or close the disc's window if no program is in use.)

- 3 Pull the tray all the way open and place a CD-ROM disc in the tray, with the label facing up.**

Make sure the disc is lying flat in the tray and is seated firmly on the spindle.

Avoid touching the drive's lens.

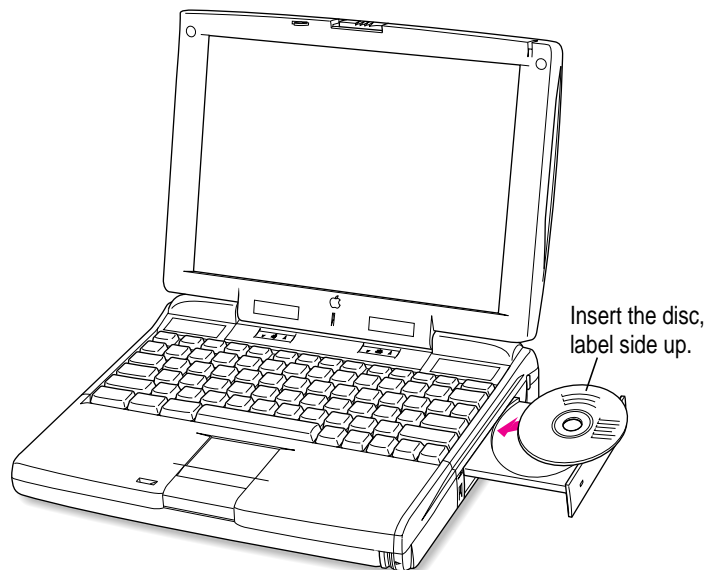

4 Push the tray in to close it.

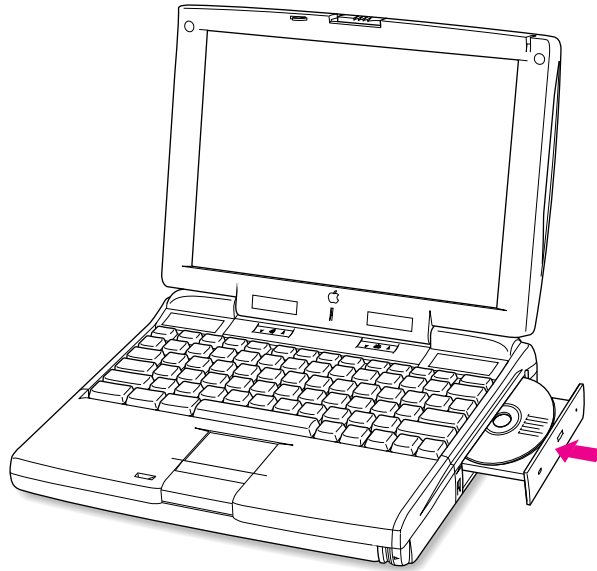

When the CD-ROM drive is in use, you may notice some vibration and noise as the compact disc spins rapidly. Certain discs can cause the drive to vibrate because they have heavily inked artwork or a label that creates an imbalance.

Variations in speed of CDs is normal. Different types of disks run at different speeds; for example, audio CDs all run at a low speed.

The high-speed CD-ROM drive for your PowerBook contains an intelligent sensor that detects an unbalanced disc and adjusts the disc speed to minimize vibration. Even when the speed changes, the CD still functions normally, but it may transfer information at a somewhat slower rate.

Some vibration is not unusual for a high-speed CD-ROM drive, in part because there is no specification for balance of compact discs. To minimize vibration from unbalanced compact discs, do not put labels on your CDs. Place the computer on a flat, solid surface when using the CD-ROM drive.

Keep the CD-ROM drive's tray closed except when loading discs. This prevents dust from getting inside the mechanism. Also be sure to keep the CD's recorded surface (the side opposite the label) free of contamination such as fingerprints, dust, and grease. The performance of the drive depends on the optical quality of the CD media.

Ejecting a disc

Follow these instructions to open the tray and eject a CD-ROM disc from the drive:

1 Open the tray.

There are several ways to open the tray of your CD-ROM drive.

If a CD-ROM disc icon appears on your screen, do one of the following:

- Select the disc icon on your screen and drag the icon to the Trash.
- Click the disc icon and choose the Put Away command in the File menu.
- While the CD player's window is active, choose Eject CD from the File menu, or simultaneously press the ⌘ and E keys. (Do not remove the module if you use this method of ejecting the disc.)
- Use the pop-up menu in the CD section of the Control Strip to eject a CD.

If no CD-ROM disc icon appears on your screen, do this:

- Press the Open button on your CD-ROM drive.

2 Take the disc out of the tray.

Store your disc in a safe place, away from heat, dust, and moisture.

3 Push the tray in to close it.

To avoid possible damage to the tray or the drive, keep the tray closed when you are not using it.

If you still can't eject a disc, try this method:

If the standard methods of ejecting a CD do not work (or the computer is shut down), you can eject the disc manually. Carefully insert the end of a straightened paper clip into the small hole near the CD-ROM drive's opening, and push firmly until the tray disengages. Pull the tray open, remove the disc, and close the tray.

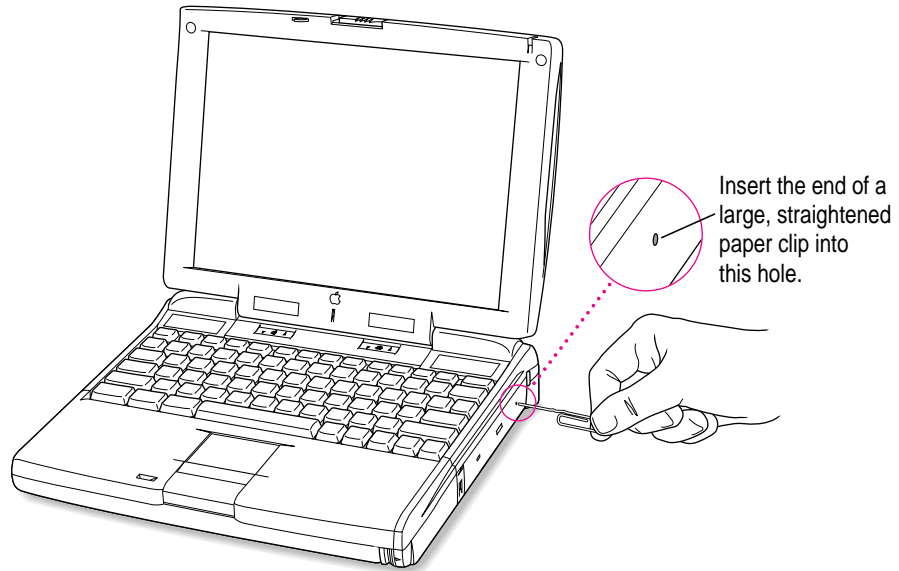

Locking an expansion bay module

You can purchase a security cable and lock to protect your Macintosh PowerBook. With a lock, you can do the following:

- secure your computer to a desk or table
- lock the expansion bay module and battery in your computer

See your Apple-authorized dealer or computer retailer for details on what security devices are available.

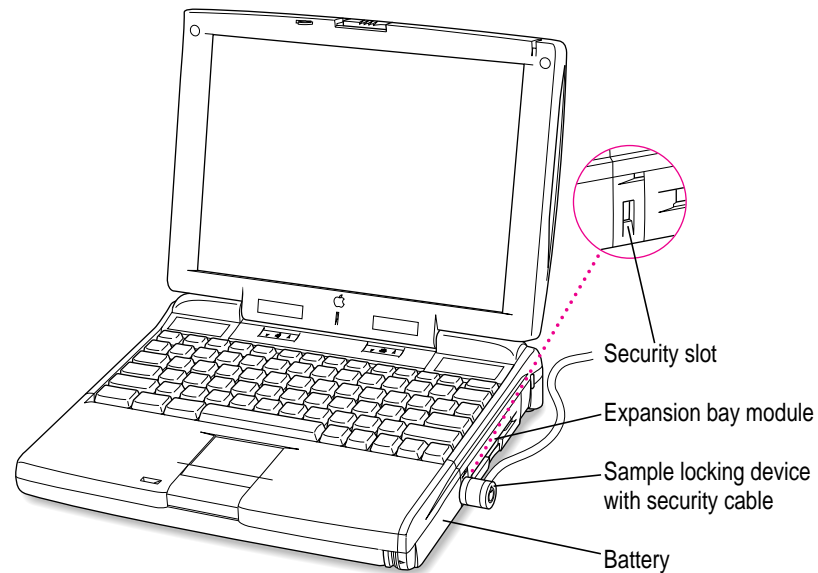

Note: You can protect the contents on your hard disk by turning on password protection in the Password Security control panel. For information on this control panel, see “How do I turn password security on and off?” in the “Setting Options” section of Mac OS Help, available in the Help menu.

Using PC Cards (PCMCIA cards)

PC Cards (also known as PCMCIA cards) are about the size of a thick credit card and have a 68-pin connector at one end. They come in many varieties, such as fax/modem cards, mass-storage cards, Ethernet connection cards, and wireless communication cards. You can use PC Cards to expand your Macintosh PowerBook's capabilities.

This section describes how to insert and eject PC Cards and how to set up your communications software to use PC Card modems. For information on using PC Cards, see the “Using PC Cards” topic area of Mac OS Help, available in the Help menu.

Your Macintosh PowerBook has two PC Card slots: an upper slot and a lower slot. You can insert a card into either slot, or you can use both slots simultaneously.

There are three types of PC Cards. The different types refer to the thickness of the card. A Type I card is 3.3 millimeters (mm) thick, a Type II card is 5 mm thick, and a Type III card is 10.5 mm thick. Make sure you check the documentation that came with your PC Card to verify that it is compatible with your Macintosh PowerBook.

WARNING Make sure you only use cards that are designated by the PC Card manufacturer as compatible with your Macintosh PowerBook. If you use an incompatible card, you may damage the card or your PowerBook. If you are not sure whether a PC Card is compatible with your PowerBook, contact the PC Card manufacturer.

You can place a Type I or Type II card in either the upper or lower slot. You can place a Type III card only in the lower slot. When a Type III card is in the lower slot, you cannot use the upper slot. You may find it useful to get in the habit of always using the lower slot to make sure the card you are using is properly inserted.

A special type of PC Card supports “Zoomed Video,” a method of showing full-motion video images in a window on the computer's screen. Your PowerBook is designed to use a Zoomed Video card, but this type of card must be placed in the lower PC Card slot.

Inserting a PC Card

To insert a card, do this:

- Insert the card, connector first and label up, into the slot. Make sure the card is level.

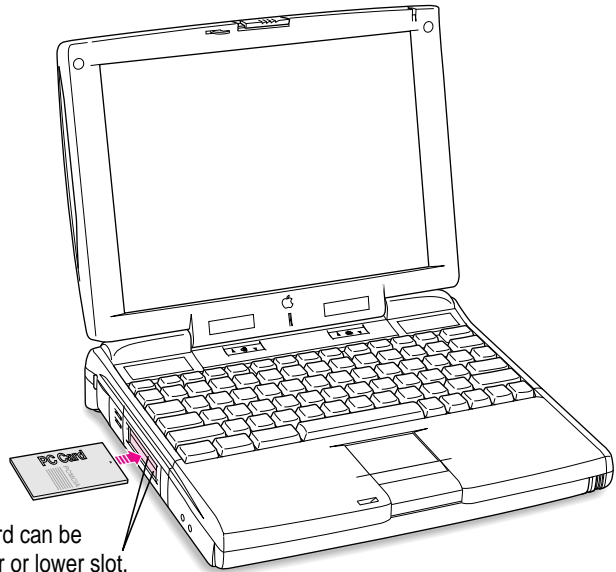

A Type I or Type II PC Card can be inserted in either the upper or lower slot.

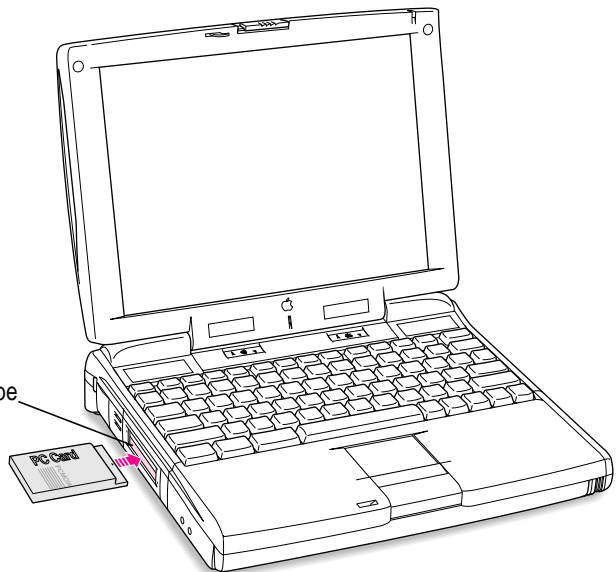

A Type III PC Card or a Zoomed Video card must be inserted in the lower slot.

You'll feel some resistance as you slide the card in. When the card is firmly seated, you will feel it click into place. Consult the card's documentation for details of its use.

An icon for the PC Card appears on the desktop.

You are now ready to use the card.

Ejecting a PC Card

Your computer must be on or off to eject a PC Card. You cannot eject a PC Card when the computer is in sleep.

IMPORTANT Before you eject a card, make sure that nothing is blocking the card's slot. If you want to use the card again immediately, pull it out about an inch more and then push it back in. (If you don't follow this procedure and you try to push the card back in to use it again, the card will not engage properly.)

To eject a PC Card when the computer is on, follow these steps:

- 1** If the computer is in sleep, press the Power key (or any key on the keyboard except Caps Lock) to wake it.
- 2** Click the PC Card's icon to select it.
- 3** Choose Put Away from the File menu.
- 4** Pull the card out of the slot.

IMPORTANT Do not pull or force a PC Card out of the slot. Doing so may damage your computer or PC Card.

Other ways to eject a PC Card when the computer is on include the following:

- Click the card's icon to select it. Drag the card's icon to the Trash. After the card is ejected, pull it out of the slot.
- Click the card's icon to select it. Open the Special menu and choose Eject PC Card. After the card is ejected, pull it out of the slot. (If a dimmed icon of the card remains on the desktop, you can drag it to the Trash.)

To eject a PC Card when the computer is on or off, do this:

- Press the eject button next to the slot containing the PC Card you want to eject. (The eject buttons do not work if your computer is in sleep.) If the card is not in use, it will usually be ejected. If the card won't eject, you'll see an alert message.

Try to use the eject buttons only when the computer is turned off. Many PC Cards won't eject when the button is pressed if the computer is on.

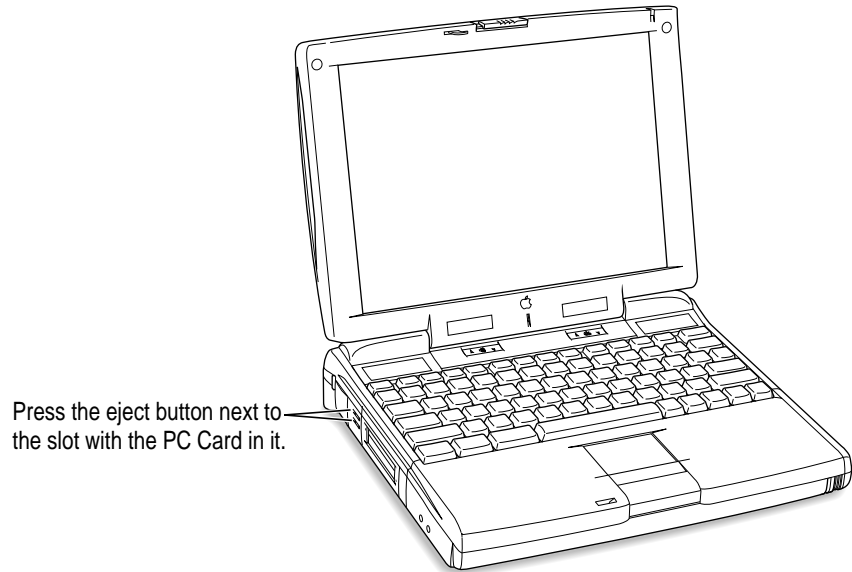

If you can't eject a card

If you are unable to eject a card, follow these steps:

- 1 Straighten one end of a paper clip.

- 2 Insert the end of the straightened paper clip into the hole next to the slot that contains the card, and press gently but firmly until the card is ejected.**

If you can't eject a card, insert the end of a straightened paper clip into the hole next to the slot. This hole is for the upper slot.

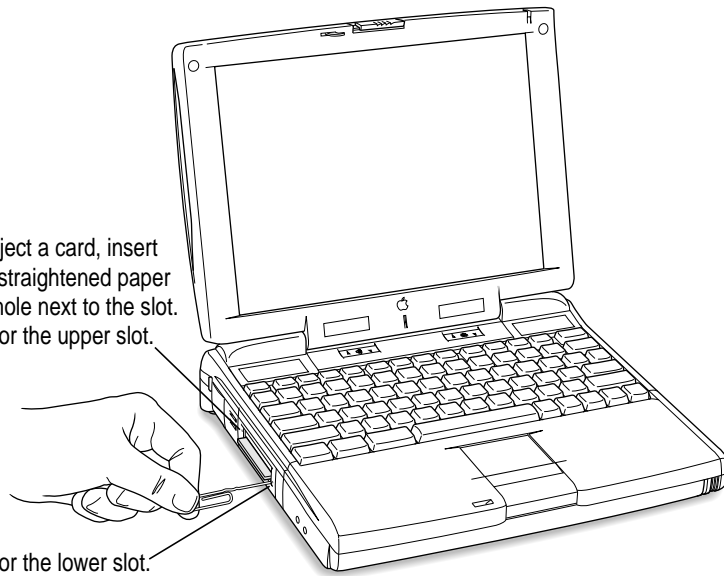

This hole is for the lower slot.

- 3 Pull the card out of the slot.**

Setting the computer not to eject storage PC Cards at startup

If you have a storage PC Card, such as an SRAM card or an ATA hard disk, in either slot, the card will be ejected when the computer starts up. To prevent excessive wear on PC Card connectors and slots, you can use the Startup Disk control panel to keep storage PC Cards from ejecting when you turn on the computer. (Other types of PC Cards, such as a modem or Ethernet card, are not ejected at startup.)

Follow these steps to avoid having a storage PC Card eject at startup:

- 1 Open the Startup Disk control panel.**

If you need instructions for opening the control panel, see “How do I make a disk the startup disk?” in the Disks topic area of Mac OS Help, available in the Help menu.

- 2 Click the icon for the computer's hard disk to select it.**

3 Close the control panel.

The PC Card storage device will no longer eject at startup.

Using a Zoomed Video PC Card

The lower PC Card slot in your Macintosh PowerBook has circuitry for handling video signals, called “Zoomed Video.” Some independent manufacturers offer PC Cards to which you can provide a video signal or connect a video camera. The Zoomed Video PC Card is a Type II card; it can only be used in the lower slot (because the special circuitry needed for video signals is located in that slot).

With a Zoomed Video card in the lower PC Card slot, the PowerBook can display video on the computer’s screen or on an external monitor. Video signals are sent directly to the video controller, so that the computer can display full-motion video while performing other tasks at the same time.

If you purchase a Zoomed Video PC Card, be sure that it has software that works with your PowerBook.

Using a PC Card modem

When you are using a PC Card modem, make sure you do the following:

1 Install the communications software you want to use, as well as any software that came with your modem.

See the documentation that came with your modem and your communications software for instructions on setting up a PC Card modem for each application. Check to see if PC Card modem files for your software were included. You can get other modem files from the manufacturer of your modem or your communications software.

2 Insert the PC Card modem.

When a PC Card modem is inserted, an icon like the one pictured below appears on the desktop:



Some card manufacturers may use a custom icon.

- 3 Plug your modem into a working phone line.
- 4 Follow instructions for setting up your modem with the communications software you are using.

WARNING When you connect a telephone line to your modem, make certain that the phone line is the standard (analog) residential line, not a digital line. Connecting a digital line to your modem card could damage it.

Read this chapter for information on expanding your computer system with additional hardware.

3

Connecting Additional Equipment



The illustration below shows where equipment should be connected to your Macintosh PowerBook. In most cases, you should refer to the manuals that came with your equipment for instructions on connecting them. The safest course is always to shut down your Macintosh PowerBook before you connect any cable other than the power adapter, although you can connect external devices to the sound port, printer/external modem port, or expansion card while the computer is on.

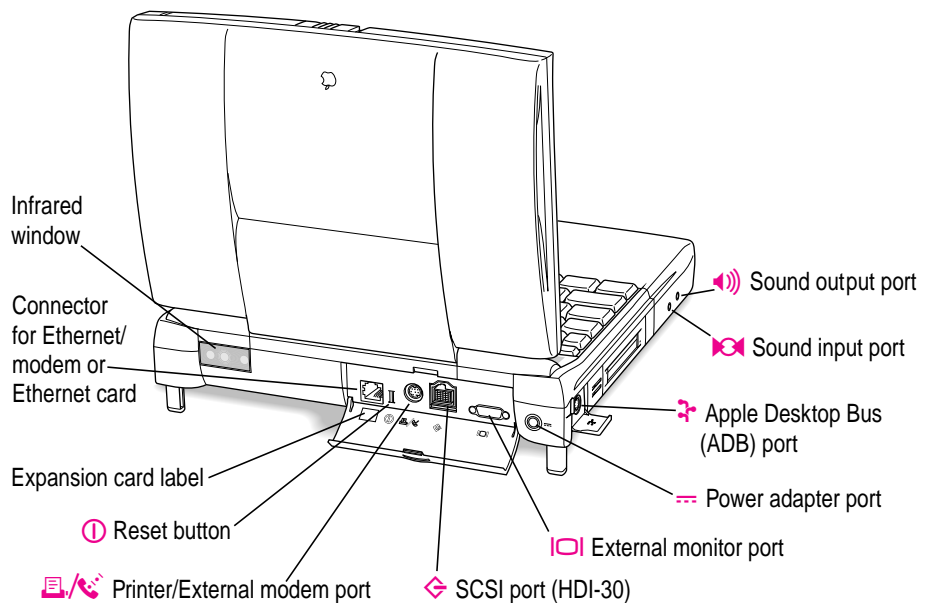

Additional information is provided in this chapter for adding the following devices to your computer system:

- printers
- external modems
- SCSI devices
- external monitors
- sound input and output devices
- a mouse, keyboard, or other ADB device
- additional memory
- IR file transfer

Connecting a printer

The modem/printer port on your computer can accept either a direct connection (to a printer such as a StyleWriter) or a LocalTalk network connection (to a printer such as a LaserWriter). See the manual that came with your printer for specific information about the type of connection it requires.

To connect a printer directly to your Macintosh PowerBook using the modem/printer port, follow these steps:

- 1** Connect your printer as instructed in the manual that came with your printer.
- 2** Open the Chooser from the Apple () menu.
- 3** Turn off AppleTalk by clicking the Inactive button in the AppleTalk section.

If you are using an Ethernet connection or a network printer, you don't have to turn AppleTalk off.

- 4** In the Chooser, select the icon for the type of printer you connected.

If you need detailed instructions for using the Chooser, see “How do I select a printer?” in the Printing topic area of Mac OS Help, available in the Help menu.

The printer is ready to use.

Connecting an external modem

You can use a PC Card modem in your computer's PC Card slot. For information on connecting and using a PC Card modem, see the documentation that came with your modem, as well as "Using a PC Card Modem" in the section "Using PC Cards (PCMCIA Cards)" in Chapter 2 of this manual, and the "Using PC Cards" topic area of Mac OS Help, available in the Help menu.

You can also connect an external modem to the modem/printer port on the back panel of the computer. The modem/printer port is GeoPort-compatible.

To connect an external modem, follow these steps:

- 1 Make sure the computer is in sleep or shut down.**
- 2 Connect the modem to a power source and to the phone line.**
- 3 Make sure the modem is turned off.**
- 4 Connect the modem cable to the port marked with this icon:**



- 5 Turn on the modem.**
- 6 Wake or restart the computer.**
- 7 Open the Chooser and select the icon for a network printer (such as LaserWriter).**

You must select a printer to be sure that the modem/printer port is available for the modem.

- 8 Turn off AppleTalk in the Chooser.**

If you see a message, click OK.

Note: If you are using an Ethernet or infrared connection, you don't need to turn AppleTalk off.

The external modem is ready to use.

Connecting SCSI devices

A SCSI device is any product—including hard disk drives, CD-ROM drives, and scanners—that communicates with your computer by means of a standard electronic interface. (SCSI stands for *Small Computer System Interface*.) You can attach up to seven SCSI devices to your computer by linking them together in a chain that starts at your computer's SCSI port.

To connect a SCSI device to your Macintosh PowerBook, you need an Apple HDI-30 SCSI System Cable or equivalent. This cable is light gray, is about 19 inches long, and has 29 pins (one “missing” pin).

Refer to the manuals that came with your SCSI devices for instructions on installing any necessary software, setting SCSI ID numbers, and connecting SCSI cables and SCSI terminators. Refer to the illustrations on the next page for the proper positioning of SCSI terminators. A SCSI chain of devices must include a terminator attached to the first and last devices in the chain (but nowhere else in the chain). Some devices include internal terminators. Your Macintosh PowerBook is internally terminated.

The names and the part numbers of the cables mentioned in this chapter are the following:

| Type of connection | Name of part | Part number |
|-------------------------------------|---------------------------------------|-------------|
| From your computer to a SCSI device | Apple HDI-30 SCSI System Cable | M2538**/A |
| From a SCSI device to a SCSI device | Apple SCSI Peripheral Interface Cable | M0207 |
| For SCSI disk mode | Apple HDI-30 SCSI Disk Adapter Cable | M2539**/A |

WARNING When connecting SCSI equipment, *always* turn off power to all devices in the chain, including your computer. If you don't, you could lose information and damage your equipment.

Where to add cable terminators when connecting a single SCSI device

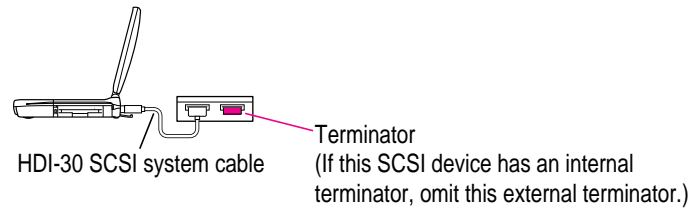

Where to add cable terminators when connecting two or more SCSI devices

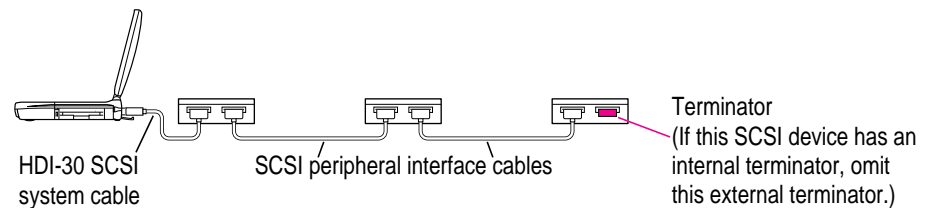

Using your Macintosh PowerBook as a hard disk

You can purchase a cable called the Apple HDI-30 SCSI Disk Adapter that lets you connect your Macintosh PowerBook to another computer as a hard disk. The PowerBook's internal hard disk drive appears on the desktop of the other computer as a hard disk icon, and you can transfer information between the computers by dragging files. This feature is called *SCSI disk mode*.

The Apple HDI-30 SCSI Disk Adapter cable is dark gray, is about 10 inches long, and has 30 pins.

IMPORTANT Whenever you use your PowerBook in SCSI disk mode, be sure that the power adapter is plugged in. If you connect the PowerBook as a SCSI disk under battery power, the battery's low-power warning will not be displayed and the computer may shut down because the battery is drained.

Connecting your computer as a hard disk

Before making any connections, you need to assign a unique SCSI ID number to the PowerBook. (The unique ID number allows the computer to communicate with several connected devices.)

- 1 Choose Control Panels from the Apple () menu of your PowerBook.
- 2 Open the PowerBook Setup control panel.



PowerBook Setup

- 3 In the SCSI disk mode section of the control panel, click the ID number you want to assign.

If you are connecting the Macintosh PowerBook to an existing SCSI chain, make sure to give it an ID number different from those of the other devices. (Many devices include an ID number indicator on the back panel.)

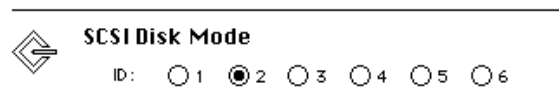

- 4 Close the PowerBook Setup control panel.
- 5 Press the Power (⌘) key on the PowerBook once to get the Shut Down dialog box and click Shut Down to turn the PowerBook off.
- 6 Shut down the computer you are connecting to and turn off any other devices in the SCSI chain.

WARNING Always shut down the PowerBook before connecting or disconnecting the SCSI disk adapter cable. Connecting the adapter cable while the computer is turned on can damage the computer.

- 7 Connect the small connector on the Apple HDI-30 SCSI Disk Adapter to the SCSI port on your PowerBook.

- 8 If you are connecting the Macintosh PowerBook directly to the other computer (rather than to an external device in the SCSI chain), attach a SCSI system cable to the other computer.
- 9 Connect the large connector on the Apple HDI-30 SCSI Disk Adapter cable to a SCSI cable attached to the SCSI port on the last device in the SCSI chain, or to the SCSI system cable on the other computer.
- 10 Turn on the PowerBook by pressing the Power key.

After a few seconds a SCSI icon appears on the screen, showing the ID number you assigned in step 3.



WARNING If you do not see the SCSI icon, and the computer starts up normally or displays an error message, press the Power key to shut down (if you can) and then immediately disconnect your computer from the SCSI chain. (If you can't choose Shut Down, try pressing the reset button. If you cannot shut down your Macintosh PowerBook, you should disconnect the cable anyway, or you may lose information.) Then go back and repeat steps 5 through 10, making sure to use the proper cables.

You may not be able to have password protection turned on in the Password Security control panel while using your PowerBook in SCSI disk mode. Turn password protection off if you experience problems. See “How do I turn password security on and off” in the “Setting Options” topic area of Mac OS Help, available in the Help menu.

- 11 Turn on the other SCSI devices in the chain, if any.
- 12 Turn on the other computer.

The PowerBook's internal drive appears as a hard disk icon on the screen of the computer you connected it to. You can now transfer and use files as if the Macintosh PowerBook were an external disk drive.

Drawing battery power in SCSI disk mode

Your Macintosh PowerBook continues to draw battery power when you use it as a hard disk. Therefore, it is preferable to connect the power adapter whenever you use the computer in SCSI disk mode.

In some instances a low power indicator may be displayed. This symbol is a blinking low-power warning on the PowerBook's screen, like the icon below.

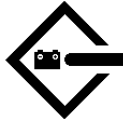

If you see this warning while using your computer as a hard disk, either plug in the power adapter or quit SCSI disk mode, as described in the next section, so you can recharge the battery.

Quitting SCSI disk mode

- 1 Shut down the computer your PowerBook is connected to.
- 2 Press the Power (<⏻> key once on the PowerBook to get the Shut Down dialog box.
- 3 Turn off any other SCSI devices in the chain.
- 4 Disconnect the PowerBook from the adapter cable.

IMPORTANT Do not leave the adapter cable attached to the PowerBook. If you do, the computer will behave as though it is still in SCSI disk mode when you try to restart.

- 5 If necessary, disconnect the adapter cable from the other computer or its SCSI chain.

Your equipment is now ready for normal use. If you disconnected the adapter cable from the other computer or SCSI chain, make sure that the SCSI chain is properly terminated.

Using an external monitor

You can connect an external monitor to your Macintosh PowerBook. If you are familiar with other PowerBook models, you will note that the types of monitors you can use with this model and the way images are displayed on an external monitor differ somewhat from other PowerBook computers.

To make the best choice of an external monitor, keep in mind the following characteristics of your PowerBook's hardware.

- Your PowerBook can support a variety of external monitors, including 17-inch and 20-inch multiple-scan displays. Resolutions supported range from 512 x 384 pixels to 1024 x 768 pixels.
- The monitor port's connector on the computer's back panel is a VGA-style connector. You can connect the cable for a VGA- or SVGA-style monitor directly to your PowerBook.
- To connect an Apple (or Apple-compatible) monitor to your PowerBook, you must use the adapter that came with the computer (it has the number 590-0289 molded into it).
- Images can appear on the internal display, the external monitor, or both screens, depending on your choice of resolution on the external monitor.
- When an image appears on both screens, it is exactly the same (known as "simulscan" or mirroring). You cannot move the pointer or menu bar from one screen to the other (as you can when an external monitor is connected to other PowerBook models or to most Macintosh desktop models).
- When an external monitor offers the same resolution as the PowerBook's internal display (800 x 600 pixels at 60 hertz [Hz] refresh rate), the image appears on both screens the first time you turn on the computer (unless the PowerBook's display is closed).
- The PowerBook is designed to be "plug-and-play" when an external monitor is attached. If the monitor is Apple-compatible, the PowerBook tries to use the highest resolution possible. If the external monitor is not Apple-compatible but provides a list of its capabilities, the system uses that list of resolutions. If no list of resolutions is provided by the monitor, the system uses a resolution of either 800 x 600 pixels or 640 x 480 pixels as the default for that monitor.

- If the PowerBook starts up with the display closed (called “docking mode”) and an external monitor is attached, the PowerBook’s display does not turn on and the display’s resolution (800 x 600) is not listed in the resolution section of the Control Strip.

For complete instructions on adjusting the resolution for an external monitor, see the “Monitors” topic area of Mac OS Help, available in the Help menu.

The list below shows the external monitors and the resolutions, refresh rates, and number of colors supported by your PowerBook.

| Monitor type | Resolution | Refresh rate (Hz) | Number of colors† |
|--|------------|-------------------|--|
| 12" RGB | 512 x 384 | 60 | 256, thou, mil |
| 13"/14" RGB Hi-Res & 12" Monochrome | 640 x 480 | 67 | 256, thou, mil |
| VGA displays | 640 x 480* | 60 | 256, thou, mil |
| | 640 x 480 | 72 | 256, thou, mil |
| | 640 x 480 | 75 | 256, thou, mil |
| | 640 x 480 | 85 | 256, thou, mil |
| | 800 x 600 | 56 | 256, thou, mil |
| | 800 x 600 | 60 | 256, thou (Simulscan for PowerBook screen) |
| | 800 x 600 | 72 | 256, thou, mil |
| | 800 x 600 | 75 | 256, thou, mil |
| | 800 x 600 | 85 | 256, thou, mil |
| | 1024 x 768 | 60 | 256, thou |
| | 1024 x 768 | 70 | 256, thou |
| | 1024 x 768 | 75 | 256, thou |

| Monitor type | Resolution | Refresh rate (Hz) | Number of colors† |
|---------------------------|------------|-------------------|---|
| Full-Page Monochrome | 640 x 870 | 75 | 256 |
| Full-Page RGB | 640 x 870 | 75 | 256, thou |
| 16" Color | 832 x 624 | 75 | 256, thou, mil |
| 19" Color | 1024 x 768 | 75 | 256, thou |
| Apple 15" Multiscan | 640 x 480 | 67 | 256, thou, mil |
| | 800 x 600 | 60 | 256, thou (Simulscan for PowerBook screen) |
| | 832 x 624 | 60 | 256, thou, mil |
| Apple 17" Multiscan | 640 x 480 | 67 | 256, thou, mil |
| | 800 x 600* | 60 | 256, thou (Simulscan for PowerBook screen) |
| | 832 x 624 | 75 | 256, thou, mil |
| | 1024 x 768 | 75 | 256, thou |
| Apple 20" Multiscan | 640 x 480 | 67 | 256, thou, mil |
| | 800 x 600* | 60 | 256, thou (Simulscan for PowerBook screen) |
| | 832 x 624 | 75 | 256, thou, mil |
| | 1024 x 768 | 75 | 256, thou |
| NTSC Display (Interlaced) | 512 x 384* | 60 | 256, thou, mil |
| | 640 x 480 | 60 | 256, thou, mil |
| PAL Display (Interlaced) | 640 x 480* | 50 | 256, thou, mil |
| | 768 x 576 | 50 | 256, thou, mil |

* An asterisk indicates the startup resolution. Other resolutions can be selected using the Control Strip.

† thou = thousands of colors; mil = millions of colors

Note: Your PowerBook supports the Video Electronics Standards Association (VESA) Display Data Channel (DDC) Standard. Specifically, it supports the DDC2B transfer protocol. When a monitor supporting this standard is connected, the PowerBook automatically recognizes the resolutions the monitor can display. You use the monitor resolution section of the Control Strip or the Monitors & Sound control panel to change resolution.

Connecting an external monitor

To connect an external monitor to your PowerBook, follow these steps. Also consult the documentation that came with the monitor.

- 1 Press the Power (⌘) key once to get the Shut Down dialog box.**
- 2 Click Shut Down or Sleep.**

If you connect a monitor with your computer turned on, the computer will not recognize the monitor.

- 3 Place the monitor near the PowerBook.**

Keep the computer and the monitor at least 8 inches apart. Interference between the monitor and your computer's floppy disk drive can cause errors on your floppy disks.

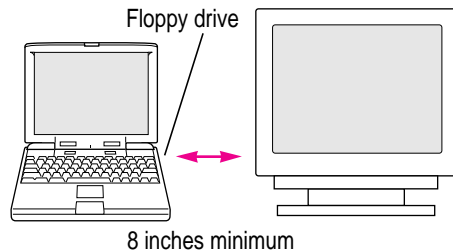

Arrange the monitor so the top of the screen is slightly below eye level while you work. Position the monitor to minimize glare and reflections on the screen from lights and windows.

- 4 Make sure the monitor's power cord is attached to the monitor. Plug the other end into a grounded outlet or power strip.**

If your monitor's power cord is designed to plug into the power receptacle on the back of a computer, rather than into an electrical outlet, you can obtain a cord with the correct plug from your Apple-authorized dealer.

If you are using a power strip, make sure it is turned on.

- 5 If you are connecting an Apple or Apple-compatible monitor, locate the adapter that came with your computer and attach it to one end of the external monitor's cable.**

The monitor adapter is a small plastic and metal device that is the same color as the computer. The number 590-0289 is on the adapter.

If you are connecting a VGA or SVGA monitor, skip this step.

- 6 Make sure the other end of the monitor's cable is attached to the monitor. Then attach the end of the cable (with the monitor adapter, if it's an Apple-compatible monitor) to the external monitor port on the back of the PowerBook.**

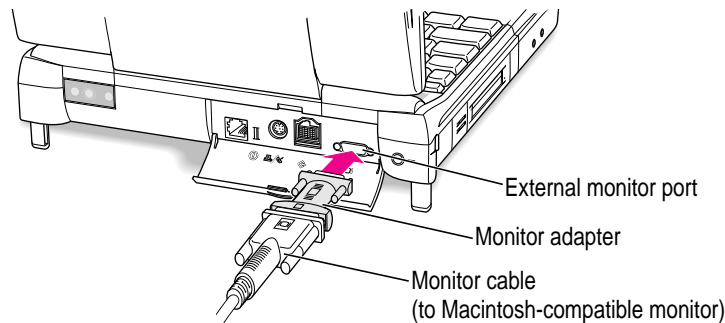

If you are connecting a VGA or SVGA monitor, do not use the adapter. Connect the monitor cable directly to the external monitor port on the PowerBook.

- 7 Turn on the external monitor.**
- 8 Press the Power (⏻) key to turn on your computer. (You can press any key if your PowerBook is in sleep.)**

The external monitor is automatically activated. You can use the Control Strip to change the resolution on the monitor. See the “Monitors” topic area of Mac OS Help, available in the Help menu, for instructions.

Trouble with the external monitor?

- **Nothing happened when you tried to turn on the PowerBook.**

Make sure that all your equipment is connected properly. Then try pressing the Power (⏻) key again.

Make sure that the battery is charged, or that the power adapter is plugged into both the computer and an electrical outlet. If you are using a power strip, make sure it is turned on.

- **The computer is on, but the external monitor is dark.**

Make sure that the monitor's power cord is connected and that its power switch is on. Try adjusting the monitor's brightness and contrast settings. If this doesn't work, try restarting your computer.

The external monitor will be dark if the PowerBook display is active and simulscan is not active. The external monitor's resolution must be set to 800 x 600 at 60 Hz for both screens to display the computer's image; when the external monitor is set to any other resolution, only one display is active.

Note: The screen-dimming feature in the PowerBook control panel turns the screen brightness down to a low level when you haven't used the computer for a few minutes. (You can think of dimming as "screen sleep.") Dimming also affects the external monitor. When you move your finger on the trackpad or press a key on the keyboard, the brightness is restored on both screens.

Disconnecting an external monitor

- 1 **Make sure your computer is shut down or in sleep.**
- 2 **Make sure your monitor is switched off.**
- 3 **Disconnect the monitor cable (for a VGA-style monitor) or monitor adapter (for an Apple or Apple-compatible monitor) from the external monitor port on the computer's back panel. The port is marked with this icon: .**

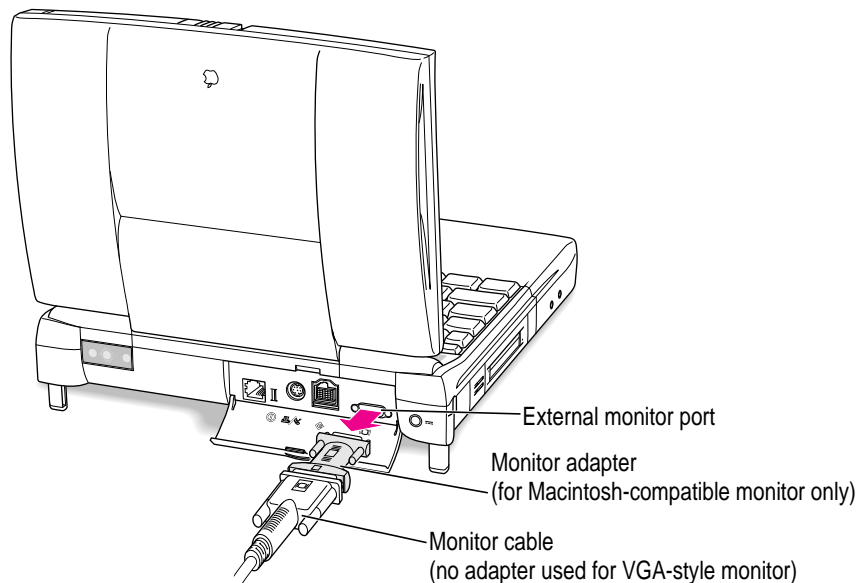

Connecting sound input and output devices

Your computer has a built-in microphone. In addition, you can connect a PlainTalk microphone to the sound input port. (You can also connect a standard line-level input microphone, although it is not suitable for speech recognition.)

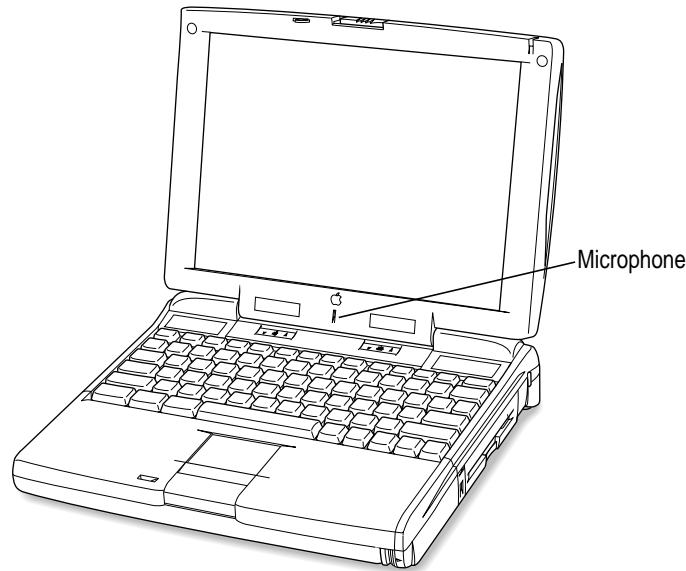

For information on using the microphone to record sounds, see the “Sound” topic area of Mac OS Help, available in the Help menu.

Your Macintosh PowerBook also has a stereo sound input port (on the left side of the computer’s case, marked with the  icon) for connecting external sound input devices that provide line-level output. You cannot use the internal microphone and an external sound input device, such as a PlainTalk microphone, at the same time. For instructions on selecting a sound device, see the “Sound” topic area of Mac OS Help, available in the Help menu.

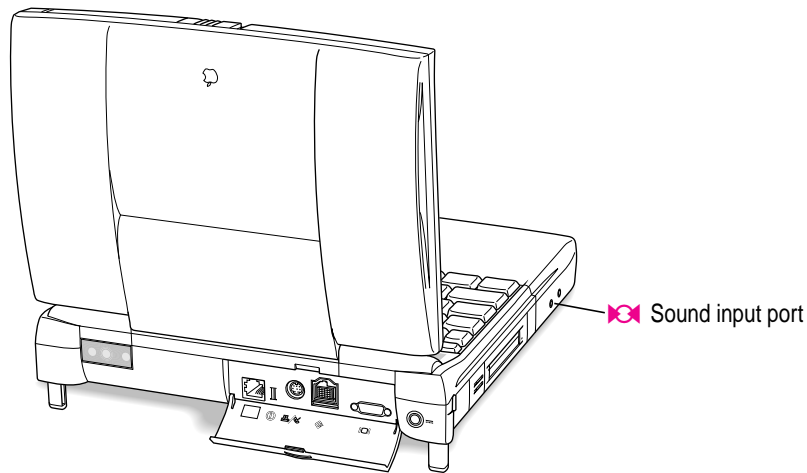

IMPORTANT Although the internal microphone is deactivated when an external sound input device is in use, it's possible to record sound from more than one sound device at the same time. This can occur because the computer merges sound from devices in the expansion bay, such as an audio CD, with sound from the PC Card slots, such as a television tuner card, and from the internal expansion card slot (called PCI). If two or more devices in these locations produce sound, the sound from all of the devices may be recorded when you use the SimpleSound program or the Monitors & Sound control panel to record. To eliminate the sounds you don't want to record, remove or turn off the device producing those sounds.

The Macintosh PowerBook also has a stereo sound output port (on the left side of the computer's case, marked with the  icon) to which you can connect externally powered speakers, an amplifier, headphones, or other audio output devices. The sound output port accepts a standard stereo miniplug, like that used to attach headphones to a portable tape player.

Your computer also has four stereo speakers, which play sound from an audio CD in the CD-ROM drive, from an external stereo device connected to the computer through the sound input port, from a Zoomed Video card in the lower PC Card slot, or from a file on your hard disk.

You can adjust sound output quality in the Monitors & Sound control panel. (For instructions, see the “Sound” topic area of Mac OS Help, available in the Help menu.) The computer automatically selects the sound output source. If an external device, such as headphones, is connected, sound is routed there; if no external output device is connected, sound plays through the computer’s four speakers.

You can also use the Control Strip to adjust sound volume.

Connecting a mouse, keyboard, or other ADB device

You can connect a mouse, keyboard, graphics tablet, or other Apple Desktop Bus (ADB) device to the ADB port on the left side of the computer’s case, behind the PC Card slots. The ADB port has a small cover, which you open to connect the device.

IMPORTANT You must shut down the computer or put it in sleep before connecting an ADB device.

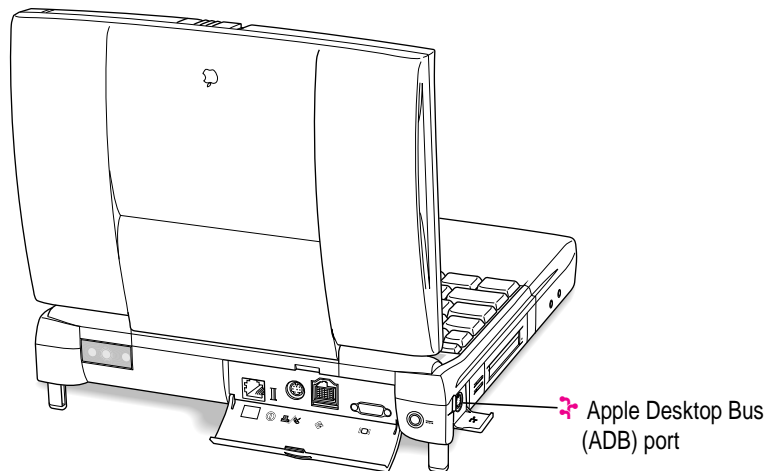

Connecting other devices

For instructions on connecting a device not discussed in this chapter—for example, networking hardware—refer to the manuals that came with the device.

Adding memory to your computer

Your Macintosh PowerBook comes with 32 megabytes (MB) of random-access memory (RAM). You can increase your computer's memory by adding a RAM expansion card. You can find out how much memory your computer has by choosing About This Computer from the Apple (🍏) menu in the Finder.

You can purchase memory upgrades from Apple-authorized dealers. For complete instructions on installing a RAM expansion card, see Appendix C.

Your Macintosh PowerBook also supports virtual memory, a feature that uses hard disk space as if it were RAM. Your computer comes with virtual memory turned on. For information on using virtual memory, see the “Memory” topic area of Mac OS Help, available in the Help menu.

Using infrared file transfer

Your Macintosh PowerBook has built-in infrared (IR) communication features that allow you to send and receive data without wires. You can exchange files with another PowerBook or with a desktop Macintosh that is using an external IR module such as Farallon's AirDock. In addition, you can use IR to make a wireless connection to a network by means of a specialized local area network (LAN) access device, such as Hewlett-Packard's NetBeamIR or Extended Systems' JetEye, that is compatible with the Infrared Data Association (IrDA) Standard specifications.

To transfer files, your computer and the other IR device must be within range of each other with the IR windows facing. The range depends on the devices and the method of communication.

Two PowerBook computers must be within 5 feet of each other to exchange files using the IRTalk transfer protocol (at 230 kilobits per second). Your computer must be within 3 feet of a LAN access device or another PowerBook computer that complies with the IrDA Standards to make a connection (at a transfer rate of 1 megabit per second).

You use the Infrared control panel to select the method of IR communication you want to use or to view the status of an IrDA connection. For instructions on IR file transfer, see “How do I use infrared communication?” in the “Organizing Your Files” topic area of Mac OS Help, available in the Help menu.

4

Power Management



Power sources

Your computer can draw its operating power from three sources.

- **Main battery** Your computer came with a lithium ion (LiIon) battery. This battery provides power for 2–4 hours of work time (you may get longer work time, depending on the Macintosh PowerBook model you have and the battery conservation features you use).
- **Optional battery** Your computer can also use a nickel-metal-hydride (NiMH) battery. This battery provides somewhat less work time than the LiIon battery supplied with your computer. The precise amount of work time with a NiMH battery depends on the Macintosh PowerBook model you have and the battery conservation features you use.
- **AC power** You can run your computer from a grounded electrical outlet by plugging in the external power adapter that came with your computer. The installed battery will automatically be charged whenever the external AC adapter is connected. The external adapter will charge the battery more quickly if the computer is shut down or in sleep, rather than turned on or operating.

IMPORTANT Use only the external power adapter that came with your computer (model number M4895) or one made specifically for this PowerBook model.

In addition, the PowerBook contains a rechargeable backup cell to keep system information such as date and time. The backup cell is automatically recharged whenever the external AC adapter is connected. The backup cell also provides up to 4 minutes of power during system sleep while you change the main battery. (See “Removing or Replacing the Battery” later in this chapter for more information about changing batteries.)

Monitoring the battery charge

There are four ways you can determine the charge level of your battery:

- Look in the battery monitor portion of the Control Strip.
For information on the battery monitor, see the “Batteries & Power” topic area of Mac OS Help, available in the Help menu.
- See low-power messages on your display.
- Look at the battery level icon next to the clock in the menu bar.
- Look at the battery level indicator lights on the battery, visible when the battery is out of the computer.

Responding to low-power messages

When the battery runs low, the computer displays a series of low-power messages. The work time remaining after you see the first message varies depending on how you are using the computer. It’s a good idea to act promptly.

What you should do

When you see a low-power message, you should do the following:

- 1 **Plug in the power adapter, or**
- 2 **Save your work and shut down the computer, then**
- 3 **Quickly replace the empty battery with a charged one (within 30 seconds, if possible).**

IMPORTANT Always save your work when you see a low-power message.

What you should know

When the first low-power message appears, the screen dims automatically to save power.

If you continue to work without plugging in the power adapter or changing the battery, the computer displays a second low-power message indicating that the computer is about to put itself to sleep. Within a few seconds, the computer goes to sleep automatically to protect the contents of RAM. All activities are interrupted. It's a good idea to save your work when you see the first low-power message to make sure you don't lose information.

If you continue working until the computer goes to sleep automatically, you can wake it again as soon as you plug in the power adapter or replace the battery with a charged battery.

If you can't plug in the power adapter, the contents of RAM are retained in sleep for about a day (as long as you don't remove the battery).

IMPORTANT Recharge a depleted battery as soon as possible. Leaving a depleted battery in the computer for a length of time (especially in a hot location, such as the trunk of a car) may damage the battery so that it can't be recharged. If this happens, you need to replace the battery.

Using the battery icon

There is a battery icon in the menu bar that tells you the charge left in your battery.

 The amount of black in the icon indicates the charge level. (full here)

 When a lightning bolt appears in the icon, the battery is charging.

Using the battery level indicator lights (on a lithium ion battery only)

You can tell the charge left in your LiIon battery by looking at the battery level indicator lights on the battery itself. Follow these steps to determine the charge level:

- 1 **Save your work and then shut down the computer or plug in the power adapter.**
- 2 **Pull the battery out of its compartment.**

For instructions on removing the battery, see “Removing or Replacing the Battery” later in this chapter.

- 3 **Push the battery level indicator button to activate the battery level indicator lights.**

The lights show whether the battery is fully charged, three-fourths charged, one-half charged, or empty (not shown in the illustration). A lighted square indicates that the battery has power; an unlighted square (black in the illustration) indicates lack of charge. The indicator lights remain lit for a few seconds.

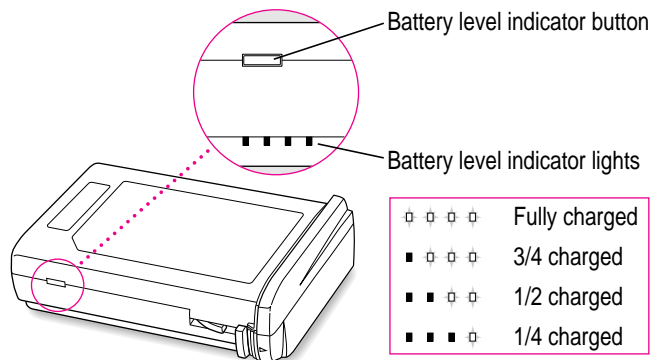

IMPORTANT If the battery lights are blinking, there’s a problem with the battery. See an Apple-authorized service provider for assistance.

You can purchase a second battery from an Apple-authorized dealer, so that you have a backup source of power when you can’t use the AC adapter.

Recharging the battery

To recharge the battery, plug in the power adapter. Your computer's batteries may be charged inside the computer. You may also use an external battery charger designed specifically for your model of the Macintosh PowerBook.

Note: It is normal for the computer to start up when power is applied and the PowerBook has been in storage or the battery is discharged or has been removed from the computer.

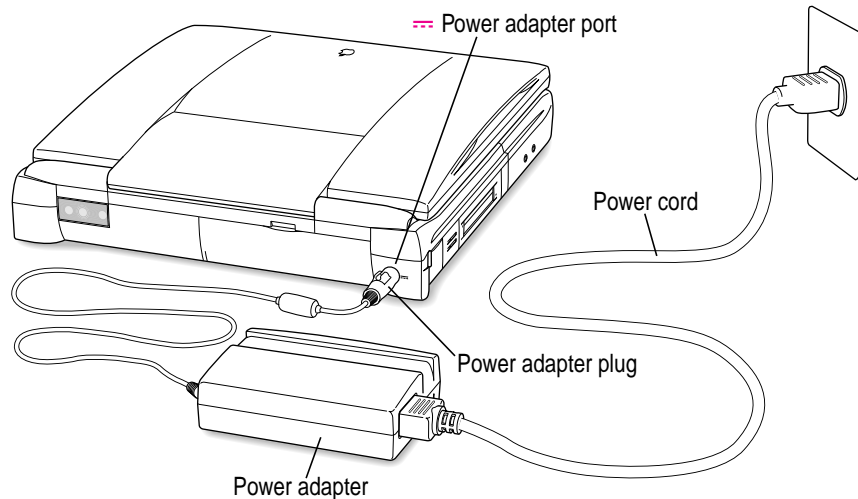

A lightning bolt icon appears in the battery monitor portion of the Control Strip when the power adapter is plugged in and a battery is recharging.



The battery is recharged regardless of whether you are using the computer, or the computer is off or in sleep; however, it will recharge more quickly if the computer is off or in sleep.

WARNING Use only the external power adapter that came with your computer or one made specifically for this PowerBook model. Adapters for other electronic devices (including other portable computers) may look similar, but they may damage your computer.

Removing or replacing the battery

To remove or replace the battery, follow these steps:

- 1 Save your work and then shut down the computer or put it to sleep, or plug in the power adapter.**
- 2 Close the display.**
- 3 Press the battery release button on the battery.**

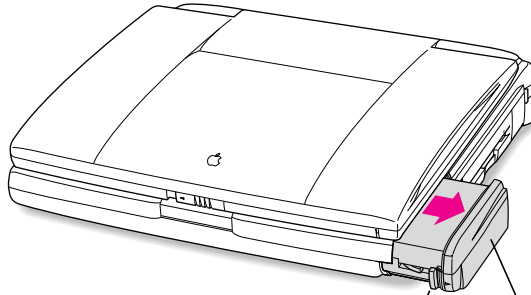

1 Press the button on the battery. 2 Slide the battery out.

- 4 Pull the battery out of its compartment.**
- 5 Put the battery cap on the battery to protect the battery contacts.**

Always snap the battery cap on the battery when the battery is out of the computer.

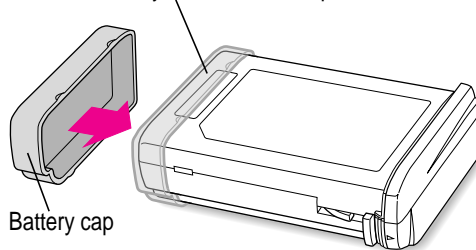

Battery cap

The battery contacts should not be exposed when the battery is out of the computer.

- 6** If you are inserting another battery, remove the battery cap from the new battery to expose the contacts, then slide it into the battery compartment.

You cannot insert a battery if the battery cap is still on the battery. You can replace the battery with another LiIon battery. Make sure you only use a battery that is designed for your Macintosh PowerBook. You should store the battery cap in case you want to remove and transport the battery later.

IMPORTANT If you take out the main battery while the computer is in sleep and it is not connected to an external power adapter, you must insert another battery within 30 seconds or you may lose any unsaved work.

- 7** If you just inserted a new battery, it's a good idea to plug in the power adapter in case the battery is not fully charged. You can look at the indicator lights on the battery to see the level of charge.



IMPORTANT Lithium ion (LiIon) and nickel-metal-hydride (NiMH) batteries contain metals and other substances which are hazardous when released in the environment. It is inappropriate, and in some cases unlawful, to throw batteries away with your household or business trash. Instead of throwing away your spent batteries, dispose of them as described here

- **In the United States** Return spent batteries to your Apple-authorized service provider, who will make sure they are included in Apple's battery recycling program.
- **Elsewhere** Many locations have government or Apple-sponsored collection or recycling programs for spent batteries. Dispose of spent batteries in accordance with the mandatory or voluntary battery collection programs in your location. Contact your Apple-authorized service provider for information about the recommended disposal procedures in your area.

Maximizing work time

Your Macintosh PowerBook's battery can provide 2–4 hours of work time before you need to recharge. The actual work time available depends on which model of Macintosh PowerBook you have, what equipment you're using with your computer, and what steps you take to conserve power while you work.

Some battery-saving measures you can take include the following:

- Minimize backlighting of the display.
- Turn off AppleTalk if your PowerBook is not connected to a network.
- Set the hard disk to spin down after a very short interval.
- Remove PC Cards and CDs when they are not in use.
- Take advantage of the sleep feature of your PowerBook whenever your work is interrupted (such as when the cellular phone rings). You just need to close the display to put the computer in sleep.

For more battery conservation tips, see the “Batteries & Power” topic area of Mac OS Help, available in the Help menu.

Consult this chapter if you have questions or experience problems using your computer.

5

Tips and Troubleshooting



When you have questions

If you want to know how to do a particular task with your computer, refer to Mac OS Help in the Help menu. If the suggestions in this chapter and Mac OS Help don't solve the problem, go to Chapter 6 for instructions on some general diagnostic techniques.

When you run into trouble

While you're using your computer, you may see a bomb icon or an error message, or you may have a problem such as the pointer (Ⓚ) “freezing” on the screen. If you have trouble with your computer, take a few minutes to read the information in this chapter and Chapter 6. If your problem is related to a particular procedure, you should also look for information on that procedure in Mac OS Help, available in the Help menu. If you are unable to access Mac OS Help (for example, if your screen is “frozen”), refer to this chapter to see if you can resolve the problem.

This chapter and Chapter 6 describe solutions to problems you may experience with your computer. If the suggestions in these two chapters don't solve your problem, contact a local Apple-authorized service provider or call the Apple Assistance Center. (See the service and support information that came with your computer for the telephone number.) If your problem is with third-party software or equipment, please call the software or equipment manufacturer for help.

Problems starting up the computer

The computer doesn't start up.

- The battery may need recharging. Plug the power cord into a working outlet and then plug the power adapter into the computer. Let the battery recharge for a few minutes.
- Check that the power cord is plugged into a working outlet. If it's plugged into a power strip, make sure the power strip is turned on. The power adapter should get warm after being plugged in for 10 minutes. If it is cold, make sure the adapter is securely plugged in and attached to the power cord.
- The screen brightness may be turned down. Adjust the brightness control (marked with the icon ☼) located above the top row of keys on the keyboard, to the right of center.
- Make sure the battery is properly seated in its compartment.
- If none of these measures helps, you may need to reset the computer. The method of resetting you should always try first is to press the Command (⌘), Control, and Power keys simultaneously. If the computer does not start up, connect the power adapter (if it is not already connected) and press the reset button (marked with the icon ⓪) on the back panel.

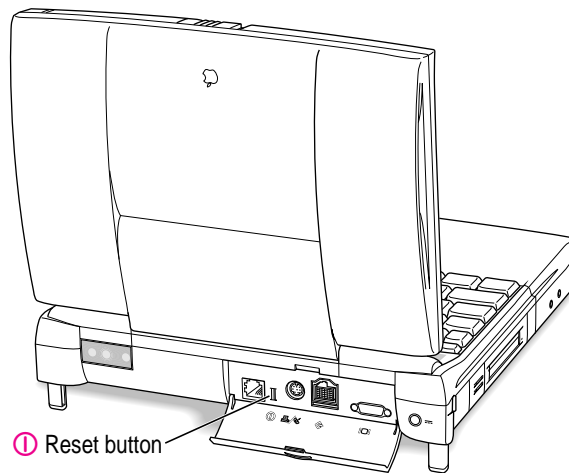

- If the reset described in the previous paragraph does not start up the computer, remove the battery and unplug the power adapter and hold in the reset button for 30 seconds. Then reconnect the power adapter and put in the battery and try starting up again.

The sleep indicator light at the top of the display glows a steady green.

You must reset the computer using the reset button. Connect the external power adapter (if it is not already connected) and press the reset button (marked with the icon ) on the back panel.



When the reset procedure is used the computer will thoroughly test the RAM, so it may take a few moments (about 1 second per megabyte of RAM) before the screen lights. Be patient if you have added expansion RAM.

The computer makes an unusual sound at startup, or you see a “sad Macintosh” icon.

- If you hear the sound of breaking glass when you turn on the computer or you see a “sad Macintosh” icon, start up the computer with the PowerBook CD that came with your computer. If the computer does not start up, or if the hard disk icon does not appear, the hard disk may need repair. Contact an Apple-authorized service provider or call the Apple Assistance Center. If the hard disk icon does appear, see Chapter 6 for information about reinstalling the system software.
- There may be a problem with the information stored in the area called parameter RAM (PRAM). Reset the PRAM (also called “zapping the PRAM”).

Resetting the PRAM erases the contents of your RAM disk, if you have one. Resetting the PRAM also restores the default settings in most control panels. After you reset the PRAM, be sure to check any custom settings you made for the desktop pattern, memory, network, AppleTalk, trackpad, power conservation, and so forth. Resetting the PRAM also resets the power manager.

Follow these steps to reset the PRAM:

1. Locate the keys Command () , Option, P, and R.
2. Make sure the Caps Lock key is not down.
3. Restart your Macintosh (using the Command [], Control, and Power keys or the reset button, if necessary). Immediately after hearing the startup sound, press the Command () , Option, P, and R keys simultaneously.

If you don't hold down the key combination within 5–10 seconds after you restart, you may need to repeat steps 1–3.

4. Hold down the keys until you hear the startup sound again.

5. If the computer shuts itself off, press the Power key to turn it back on.
 6. When the computer has finished starting up, restore any custom control panel and network settings.
- If nothing happens after you reset the PRAM, there may be a problem with a RAM expansion card. If you installed a RAM expansion card in your computer, check Appendix C to make sure the card is properly installed. If you purchased an expansion card from a third-party manufacturer, contact the manufacturer for help.

See also “The Computer Makes Unusual Sounds” in the section “Other Problems While Working” later in this chapter.

The computer starts up, but the desktop doesn’t appear.

- The screen brightness may be turned down. Adjust the brightness control (☼), located above the top row of keys on the keyboard, to the right of center.
- The computer may be trying to start up using an external hard disk that does not contain the correct system software. Disconnect the external hard disk and restart your computer. (This can also happen with PC Card drives and expansion bay drives.)
- Start up the computer, holding down the Shift key until you see the message “Extensions off” in the “Welcome to Macintosh” box. If the computer starts up, turn to Chapter 6 and try the steps given in the section “Checking Your System Software Extensions.” You can go directly to the Extensions Manager control panel by holding down the Space bar during startup.

When you start up the computer, you see a message about the system software.

- The system software on the startup disk you’re using may be incomplete or damaged, or may be the wrong version. Make sure you’re using the correct disk as a startup disk. (You can start up from the CD that came with your computer by pressing the letter “c” as the computer starts up.)
- If you’re sure you’re using the correct startup disk, you may need to reinstall system software. See “Reinstalling System Software” in Chapter 6.

The computer displays a flashing question mark icon.



- This icon usually means that the computer can't find system software on any disks attached to the computer. If the computer is connected to any external hard disks, make sure they are turned on. Then restart the computer. If the problem recurs, the hard disk or its system software may be damaged. See Chapter 6.
- Turn off the computer, disconnect all external devices except the power adapter, and restart the computer. If the computer starts up, turn to “Problems with Equipment Connected to Your Computer” later in this chapter.

The computer freezes or displays an error message during startup.

- Turn off the computer, disconnect all external devices except the power adapter, and restart the computer. If the computer starts up, turn to “Problems with Equipment Connected to Your Computer” later in this chapter.
- Start up the computer, holding down the Shift key until you see the message “Extensions off” in the “Welcome to Macintosh” box. If the computer starts up, turn to Chapter 6.

About the codes in error messages: The number codes in error messages are used in software development. Sometimes they can help a technician narrow down the source of a problem. However, the codes are usually too general or technical in nature to help you diagnose a problem yourself.

When the computer starts up, a message says there is not enough memory.

There may not be enough memory to load all the system software extensions you've installed. Restart the computer, holding down the Shift key until you see the message “Extensions off” in the “Welcome to Macintosh” box. Then try the following to increase available memory:

- Turn on virtual memory in the Memory control panel, or increase the virtual memory size if it's already on. Your PowerBook can deliver good performance with virtual memory set to two to three times the amount of actual RAM in the computer.

- Reduce the size of the disk cache in the Memory control panel.
- If you use a RAM disk, reduce its size or turn it off in the Memory control panel.
- Use the Extensions Manager control panel (in the Control Panels folder inside the System Folder on your hard disk) to turn off extensions you don't need. Then restart the computer. (You can use Extensions Manager to create different sets of extensions for special situations.)

You need to restart the computer for these changes to take effect.

If these suggestions don't work, you can increase memory by installing a RAM expansion card in your computer. See Appendix C for information.

The computer won't restart.

- If the computer freezes, you can try to “force” the program you're using to quit by simultaneously pressing the keys Command (⌘), Option, and Esc on your keyboard. Then click Force Quit in the dialog box that appears. (*Note:* Unsaved changes in your current documents will be lost.) Immediately save all open documents, quit all other open programs, and restart the computer.
- You may need to reset the computer. The method of resetting you should always try first is to press the Command (⌘), Control, and Power keys simultaneously. If the computer does not start up, connect the power adapter (if it is not already connected) and press the reset button (marked with the icon Ⓞ) on the back panel.

Note: You will lose any work you have not saved.

- If the problem recurs, reset the parameter RAM (see “The Computer Makes an Unusual Sound at Startup, or You See a ‘Sad Macintosh’ Icon;” in the section “Problems Starting Up the Computer” earlier in this chapter). If the problem still occurs, see Chapter 6.

Every time the computer starts up, it rebuilds the desktop.

There may be a folder on your hard disk that has the same name as a file the computer uses to keep track of information on your disks. Manually search for a folder named “Desktop” or “Desktop file.” If you find one, rename it “Storage.” Then restart the computer. (Do not use the Find File feature to search for the desktop file. It may find it but you may not be able to access it.)

When you start up the computer, the display lights up for a moment, then shuts down.

- Make sure you are using the correct power adapter for your computer model.
- If the computer is running on the battery, make sure the battery is charged. Or connect the external power adapter.

The computer won't wake after the battery was replaced with the computer in sleep and without the power adapter plugged in.

- Connect the power adapter and press the Power key (or any other key except Caps Lock) to wake the computer.

Tip: Leave the power adapter plugged in and charging the system for at least 24 hours to ensure that the backup battery is charged enough to allow battery replacement during computer sleep.

Problems working with programs

The computer freezes or displays a system error message.

- There may be a temporary software problem. To reset the computer, try the following suggestions in order until the computer starts up normally:
 1. If the computer freezes, you can try to quit the program you're using by pressing the keys Command (⌘), Option, and Esc on your keyboard. Click Force Quit in the dialog box that appears. (You'll lose unsaved changes in that program's documents.)

Immediately save all open documents and quit all open programs, then restart the computer.
 2. If you see a message about a system error, you may need to reset the computer. The method of resetting you should always try first is to press the Command (⌘), Control, and Power keys simultaneously. If the computer does not start up, connect the power adapter (if it is not already connected) and press the reset button (marked with the icon Ⓟ) on the back panel.

Note: You will lose any work you have not saved.

3. Reset the PRAM (see “The Computer Makes an Unusual Sound at Startup, or You See a ‘Sad Macintosh’ Icon,” in the section “Problems Starting Up the Computer” earlier in this chapter for instructions).
- If the problem recurs, it may involve one or more of your application programs. See “The Computer Exhibits Odd Behavior, Such as Many Unexplained System Failures,” next.

About the codes in error messages: The number codes in error messages are used in software development. Sometimes they can help a technician narrow down the source of a problem. However, the codes are usually too general or technical in nature to help you diagnose a problem yourself.

The computer exhibits odd behavior, such as many unexplained system failures.

- Check for multiple System Folders on your startup disk, using the Find File command. Throw away extra System Folders (but do not throw away any System Folders from your RAM Disk Backup folder). The System Folder that your computer is using has a Mac OS logo on it.



System Folder

- Check for viruses on all your disks, using a virus-detection program. Eliminate any viruses the program finds.
- If a problem recurs when you are using a particular program, try the following:
 - Consult the documentation that came with the program to make sure you are using it correctly.
 - Check for multiple copies of the program on your hard disk. Use the Get Info command to check the programs' version numbers. Keep one copy of the latest version and throw away all other copies.
 - Reinstall the program from a known good source (such as the original program disks or the CD that came with your computer).
 - Increase the program's memory. Quit the program, select its icon, choose Get Info from the File menu, and type a larger number in the Preferred Size box.

- Contact the manufacturer or vendor of the program to find out whether the program contains software errors or “bugs” and whether an upgrade is available.
- Check that the program is compatible with the version of system software your computer is using. (See the program’s documentation, or contact the manufacturer or vendor.) You can find out which version of software you have by choosing About This Computer in the Apple () menu.
- Make sure your control panels and system software extensions (especially any that you recently added) are compatible with your programs. See Chapter 6.

A program won’t open.

- The application program may already be open. Check the Application menu to see which programs are running.
- There may not be enough memory available to open the program. Quit any programs you’re not using and try again. If that doesn’t work, try restarting the computer.
- If the program is on a floppy disk, make sure the disk is unlocked. (You unlock a disk by sliding the tab at the corner of the disk so that it covers the hole.)
- The program may be damaged, or it may not be compatible with PowerPC technology. Check to make sure the software is PowerPC-compatible, and install it from a known good source (such as the original program disks).
- Contact the manufacturer or vendor of the program to see if the program is compatible with the version of system software your computer is using. (Choose About This Computer from the Apple [] menu to see which version of system software you have.)

A program suddenly quits or disappears, or a message says a program has quit.

- There may be a temporary software problem. Restart the computer, then try opening the program again.
- The program may have run out of memory. See the suggestions in “A Message Says There Is Not Enough Memory,” next.
- If the problem occurs when you are trying to print, there may not be enough memory for printing.



- Contact the manufacturer or vendor of the program to see if the program contains software errors or “bugs” and if it is compatible with the version of system software you’re using.

A message says there is not enough memory.

- There may be a temporary software problem. Save your work, quit all open programs, and restart the computer. If you can’t use the Restart command, see the suggestions in “The Computer Freezes or Displays a System Error Message,” earlier in this section.
- If you get this message when you are trying to open or use a program, follow these steps:
 1. Choose About This Computer from the Apple (🍏) menu. Take note of the number in the Largest Unused Block section. This number tells you how much memory is available to open programs.
 2. Quit the program if it’s open, select its icon, and choose Get Info from the File menu. Take note of the numbers in the Minimum Size and Preferred Size boxes.
 3. If the number in the Minimum Size box is larger than the largest unused block, not enough memory is available to use this program. To free memory, quit open programs or restart the computer. You can also type a smaller number in the Minimum Size box if you want to open the program using less memory. (But some programs don’t work well if you assign them less memory.)
 4. If the number in the Preferred Size box is smaller than the largest unused block, you may need to assign more memory to the program. (A program may need more memory if you are working with complex documents.) Type a larger number in the Preferred Size box.
- If you frequently want to open more programs than memory allows, try the following:
 - Turn on virtual memory in the Memory control panel or increase the amount of virtual memory if it is already on.
 - Use the Memory control panel to reduce the size of the disk cache or remove or reduce the size of your RAM disk.
 - Install a RAM expansion card in your computer. See Appendix C for instructions.

When you try to open a document, a message says the program can't be found.

- The document may have been created with a program that is not on your hard disk, or with a different version of the program.
- You can also open a document from within a program by using the Open command in the File menu. For more information, see the documentation that came with your programs.
- If you know the correct program is on your hard disk, there may be a problem with the information that the computer uses to keep track of files. Restart the computer and hold down the Command (⌘) and Option keys until you see a message asking if you want to rebuild the desktop. Release the keys and click OK.

Note: If you have Macintosh Easy Open installed, you must use the Extensions Manager control panel to turn off all extensions except the Macintosh Easy Open control panel, and then follow the previous steps to rebuild your desktop.

A window has disappeared.

- Another open window may be covering the one you're looking for. Move, resize, close, or hide windows until you see the one you want.
- The program the window is associated with may be hidden. Choose Show All from the Application menu, then click the window you want, or choose the program from the Application menu.

Other problems while working

The screen went blank.

- Screen dimming may be on. Move the pointer to restore the screen's brightness. You can adjust the interval before screen dimming takes effect, or you can turn screen dimming off, using the PowerBook control panel.
- The computer may have gone to sleep, as indicated by the blinking sleep LED at the top of the display. Press the Power key (or any key except Caps Lock or the trackpad button) on the keyboard to wake it.
- The battery may be drained. Install a charged battery, or plug in the power adapter and let the battery charge for a few minutes. Then try to wake or start up the computer.

Some icons look different from usual.

- There may be a problem with the information that the computer uses to keep track of files. Restart the computer and hold down the Command (⌘) and Option keys until you see a message asking if you want to rebuild the desktop. Release the keys and click OK.

Note: If you have Macintosh Easy Open installed, you must turn off all extensions except the Macintosh Easy Open control panel, and then follow the previous steps to rebuild your desktop.

- You may be using a file-compression program to save space on your hard disk. Some compression programs change the appearance of icons.

When trying to open or move a font file, you see an error message.

The font file may be damaged. To remove damaged font files, follow these steps:

1. Drag the Fonts folder out of the System Folder.
2. Restart the computer.
3. Open the Fonts folder that you dragged out, and drag undamaged fonts to the System Folder icon. Click OK in the dialog box.
4. Throw away the old Fonts folder.
5. Reinstall the damaged font from the original disk.

An icon is blinking in the menu bar.

A program needs attention. Open the Application menu and choose the program whose icon is blinking (it may have a diamond by its name). Respond to any messages on the screen. If it's not clear what you should do, consult the documentation that came with the program.

A file can't be thrown away.

- The file may be locked. Select the file's icon, then choose Get Info from the File menu and click the Locked checkbox to remove the X. You can delete locked files that are in the Trash by holding down the Option key while you choose Empty Trash from the Special menu.
- An application program may be using the file. Close the file or quit the program.

- If the file is on a floppy disk, the disk may be locked. Unlock the disk by sliding the tab so that it covers the hole at the corner of the disk.
- The file may be in a shared folder that can't be changed. You can throw away the file by turning off file sharing temporarily (click Stop in the File Sharing control panel). Or you can select the shared folder, choose Sharing from the File menu, and uncheck the box labeled either "Can't be moved, renamed, or deleted" or "Same as enclosing folder."

The computer makes unusual sounds.

- A program may need your attention. If an icon is blinking in the menu bar, open the Application menu, choose the program whose icon is blinking (it may have a diamond by its name), and take the necessary action.
- Open the Easy Access control panel (if it is installed on your computer) and check whether any features are turned on.
- Select a different system sound in the Sound control panel.
- The computer sound hardware periodically turns itself off to save power. Sometimes this causes a clicking or popping noise. This sound is normal.
- If the sounds are regular or melodic, they may be caused by interference from electrical equipment. Move the computer farther away from any such equipment.

See also "The Computer Makes an Unusual Sound at Startup, or You See a 'Sad Macintosh' Icon," in the section "Problems Starting Up the Computer" earlier in this chapter.

You can't access some of the memory on your computer.

- All computers set aside some memory for system overhead.
- If you want to open more programs than memory allows, you can use the Memory control panel to decrease the size of the disk cache, or remove or decrease the size of the RAM disk (if you're using one). You can also have a memory expansion card installed in your computer.

Problems with hardware

RAM or cache diagnostic error

You see a message that a problem was detected with RAM or cache memory.

If you see this type of error message, take your computer to an Apple-authorized service provider. Ignoring this condition could lead to random errors and failure that could result in your losing data. (Although the error message may not reappear, the problem detected during the computer's self-check probably has not gone away.)

Floppy disk drive

You can't eject a floppy disk.

The disk may be stuck. Restart the computer, holding down the trackpad button. If the disk is not ejected, you can eject it manually. Carefully insert the end of a straightened paper clip into the small hole near the disk drive's opening, and push firmly until the disk is ejected.

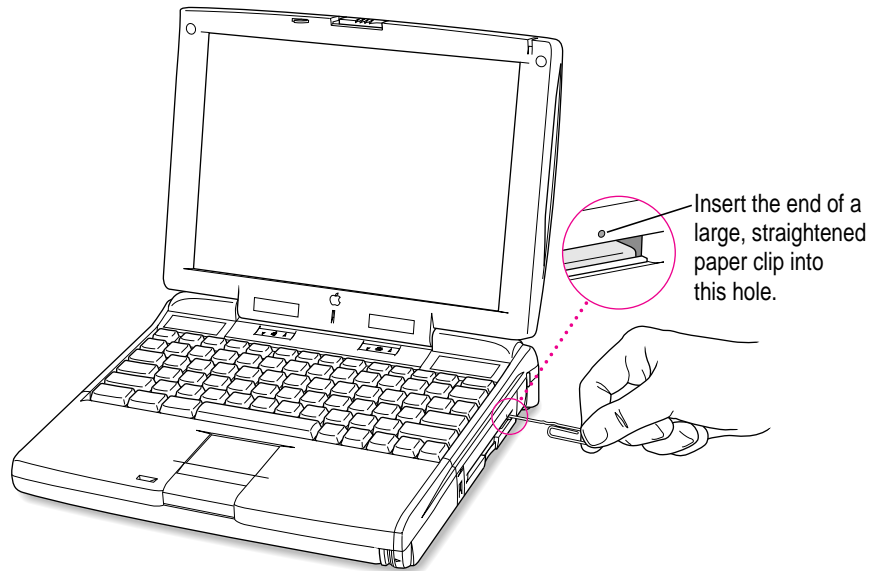

You can't save or copy files onto a floppy disk.

- The disk may be locked. Unlock it by sliding the tab at the corner of the disk so that it covers the hole.
- The disk may be full. Throw away items on the disk that you no longer need, or save the files on a different disk.
- The disk or disk drive may be damaged. Test it with Disk First Aid (on the CD that came with your computer or in the Utilities folder on the hard disk).

Hard disk drive

The computer won't start up from the internal hard disk, or the hard disk icon doesn't appear on the desktop.

There may be a temporary software problem. Turn off the computer, wait at least 10 seconds, and then turn it on again.

The hard disk keeps stopping and starting again.

The hard disk may be going to sleep to conserve power. Use the PowerBook control panel to change the power conservation settings.

The computer is using the wrong disk as a startup disk.

- Open the Startup Disk control panel and make sure the correct disk is selected. Then restart the computer.
- If you're trying to start up from an external hard disk, the computer may not be recognizing the disk. See “Problems With Equipment Connected to Your Computer,” later in this chapter.
- There may be a problem with your startup disk or with its system software. See “Testing Your Hard Disk” in Chapter 6.

Trackpad

The pointer won't move.

- A program may be doing some work. Wait a few moments and then try again.
- A temporary software problem may have caused the computer to “freeze.” See “The Computer Freezes or Displays a System Error Message” in the section “Problems Working With Programs,” earlier in this chapter.

The pointer sticks or jumps when you use the trackpad.

Make sure to use only one finger on the pad and that your finger is dry.

Keyboard

Typing on the keyboard produces nothing on the screen.

- Make sure the program you're using is set to accept text input. Usually you need to set an insertion point or select some text before typing. If you're using a communications program, you may need to turn on the "local echo" setting.
- Open the Easy Access control panel and make sure Slow Keys is turned off.
- Open Key Caps in the Apple (🍏) menu and check whether the computer is recognizing keyboard input. If so, the keys in the Key Caps window will indicate when keys are pressed on the keyboard.

A key won't stop repeating.

Open Key Caps in the Apple (🍏) menu. If any keys in the window are darkened, keys may be stuck down on your keyboard.

PowerBook display

The screen went blank.

- Screen dimming may be on. Move the pointer to restore the screen's brightness.
- The computer may have gone to sleep. Press any key (except Caps Lock) on the keyboard to wake it.
- The battery may need recharging. Plug in the power adapter, let the battery charge for a few minutes, and then try to wake or start up the computer again.
- If an external monitor is connected, the image may be displayed on that monitor and not on the PowerBook's display. (If the external monitor is set to a different resolution from the 800 x 600 pixels of the PowerBook display, the computer's image only appears on the external monitor.)

The screen flickers.

- Adjust the brightness control (☼).
- Open the Monitors & Sound control panel or use the Control Strip to set the computer to display fewer colors or grays.
- If tilting the display affects the flickering, there may be a loose cable. Contact an Apple-authorized service provider, or call the Apple Assistance Center at the number provided in the resource materials that came with your computer.

The computer freezes when screen dimming takes effect.

Screen dimming does not work with some programs. Contact the program's manufacturer to see if there is a newer version of the program that is compatible with dimming. If the problem persists, you can open the PowerBook control panel and turn off screen dimming.

External monitors

The monitor remains dark.

Shut down the PowerBook, then make sure the monitor is connected to the PowerBook, plugged into an active outlet, and turned on. (Most monitors have a light on the front panel to show whether they are on.)

The monitor is on, but no image appears.

- Use the Monitors & Sound control panel to select a resolution that will display on the external monitor. If the resolution is not 800 x 600 at 60 Hz, the PowerBook's screen goes blank when the external monitor is in use.
- Screen dimming may be on. Move the pointer to restore the screen's brightness.
- Adjust the monitor's brightness and contrast controls.
- Use the Control Strip to change the resolution on the external monitor. If you still don't see an image, there may be a problem with the monitor.
- If you are using an Apple monitor with a 15-pin connector, be sure that the video adapter that came with your computer is connected (between the monitor cable and the PowerBook's external monitor port).

The monitor goes dark after a few minutes.

Screen dimming may be turned on. Move the pointer to restore the screen's brightness. You can change the interval before screen dimming takes effect in the PowerBook control panel.

The computer freezes when screen dimming takes effect.

Screen dimming does not work with some programs. Contact the program's manufacturer to see if there is a newer version of the program that is compatible with dimming. If the problem persists, you can open the PowerBook control panel and turn off screen dimming.

There is wavy or jittery interference on the external monitor.

This interference may be generated by a magnetic field. If the monitor is near another piece of equipment (such as a TV, speakers, or another monitor), move the monitor away from the equipment.

You connected a different external monitor and it turns on but doesn't display an image.

Once you set the resolution for an external monitor, any other external monitor subsequently connected to your PowerBook will attempt to use that resolution. If you cannot set a resolution for the new external monitor that results in an image on the screen, you may need to detach the second monitor, discard the Display Preferences file (in the Preferences folder inside the System Folder), reconnect that monitor, and choose a resolution over again to see a satisfactory image. For instructions, see the Monitors topic area of Mac OS Help, available in the Help menu.)

Printers

The computer can't find the printer.

- Make sure the printer is connected and turned on.

IMPORTANT Make sure that all equipment is turned off before connecting or disconnecting cables.

- The printer may not be selected in the Chooser. Open the Chooser and select the printer you want to use. If the printer is connected to a port, make sure the correct port is selected.

- Reset the parameter RAM. (See “The Computer Makes an Unusual Sound at Startup, or You See a ‘Sad Macintosh’ Icon,” in the section “Problems Starting Up the Computer” earlier in this chapter for instructions.) Then select the printer in the Chooser and try printing again.

The printer does not appear in the Chooser.

- Make sure you’ve selected the correct kind of printer on the left side of the Chooser window. For example, if you’re using a StyleWriter II, make sure to select StyleWriter II, not StyleWriter.
- Use the scroll bars to look through all the selections in the Chooser windows.
- Check the connections between your computer and the printer, including relevant sections of the network if appropriate. (See “Problems With Networks and File Sharing” later in this chapter.)
- Make sure the correct printer software is in the Extensions folder inside your System Folder.
- If you’re using a network printer, make sure that AppleTalk is active in the Chooser. If you are using a printer connected directly to your computer, make sure AppleTalk is inactive, or the Printer/External modem port is not selected in the AppleTalk control panel.
- If your network has zones, make sure the zone containing your printer is selected.

Nothing happens, or an error message appears, when you try to print.

- There may not be enough memory for printing. Try the following:
 - Quit the program immediately after sending the Print command.
 - Increase the amount of memory that Desktop PrintMonitor uses. (Locate Desktop PrintMonitor in the System Folder, select it, choose Get Info from the File menu, and type a larger number in the Preferred Size box.)
 - Reduce the amount of memory the program uses.
- Make sure the printer is turned on. Some printers need to warm up for a few minutes after you turn them on.
- The printer may be out of paper or may need attention. Check the printer status lights and any messages on your screen.
- Open the current printer (its icon has a bold outline) and check for status messages.

- Reinstall your printer software.
- Reset the parameter RAM. (See “The Computer Makes an Unusual Sound at Startup, or You See a ‘Sad Macintosh’ Icon,” in the section “Problems Starting Up the Computer” earlier in this chapter for instructions.)

SCSI equipment and SCSI disk mode

External SCSI equipment doesn’t work, or a hard disk icon does not appear on the desktop.

- You may not be able to use password protection with your PowerBook in SCSI disk mode. Turn password protection off in the Password Security control panel.
- Check that all cables are connected securely, that the devices are plugged into working outlets, and that the devices are turned on.

IMPORTANT Make sure that all equipment is turned off before connecting or disconnecting cables.

- Make sure that you turn on SCSI equipment before you start up the PowerBook.
- Check that each connected SCSI device has a unique ID number between 0 and 6.
- Make sure that SCSI cable terminators are correctly positioned. Follow the instructions in “Connecting SCSI Devices” in Chapter 3.

You can’t turn on the computer after connecting a SCSI device.

- Turn on the SCSI equipment first, and then turn on the computer.
- Try disconnecting the SCSI equipment to determine if the computer will start up. If not, see the beginning of this chapter.

When you start up using SCSI disk mode, the desktop appears.

When you use SCSI disk mode, the computer should display an icon with a number in it.



If the computer starts up normally, immediately press the Power key to shut down (if you can) or turn off the computer. If you don't, you might damage your information or equipment.

- Make sure you are using the correct cable for SCSI disk mode. The HDI-30 SCSI Disk Adapter is about 10 inches long, is dark gray, and has 30 pins in the connector (no “missing” pins). Do not use the HDI-30 SCSI System Cable, which is light gray, is about 19 inches long, and has 29 pins in the connector (one “missing” pin). That cable is for connecting SCSI equipment to your PowerBook.
- Check that all cable connections are secure.
- The PowerBook's battery may be drained. Plug in the power adapter and let the battery charge for a few minutes. Then press the Power key on the PowerBook's keyboard to restart it, and restart the other Macintosh.
- Start up the other Macintosh with the CD or *Disk Tools* floppy disk that came with it (do not use the CD that came with your PowerBook). If the connection works, then a system software extension on the other Macintosh may be causing the problem.

When you start up using SCSI disk mode, you see a flashing question mark icon.



- Make sure you are using the correct cable for SCSI disk mode. The HDI-30 SCSI Disk Adapter is about 10 inches long, is dark gray, and has 30 pins in the connector (no “missing” pins). Do not use the longer, light gray HDI-30 SCSI System Cable.
- Make sure terminators are placed correctly in the SCSI chain. For more information, see “Connecting SCSI Devices” in Chapter 3.

The Macintosh you are connected to in SCSI disk mode doesn't see the PowerBook.

- You cannot use the PowerBook in SCSI disk mode if password protection is turned on. Turn password protection off in the Password Security control panel.

- Make sure you are using the correct cable for SCSI disk mode. The HDI-30 SCSI Disk Adapter is about 10 inches long, is dark gray, and has 30 pins in the connector (no “missing” pins). Do not use the longer, light gray HDI-30 SCSI System Cable.
- Make sure terminators are placed correctly in the SCSI chain. For more information, see “Connecting SCSI Devices” in Chapter 3.
- Check that there is no conflict between SCSI ID numbers among all devices in the SCSI chain. If necessary, you can change the ID for your computer in the PowerBook control panel.
- Start up the other Macintosh with the CD or *Disk Tools* floppy disk that came with it (do not use the CD that came with your PowerBook). If the connection works, then a system software extension on the other Macintosh may be causing the problem.

Problems with equipment connected to your computer

If a problem occurs while your Macintosh PowerBook is connected to equipment such as SCSI equipment, an external monitor, a modem, a printer, a mouse, or a keyboard, these steps may help you determine the source of the trouble:

- 1 Shut down or turn off your Macintosh PowerBook and anything that’s connected to it. Disconnect everything connected to your Macintosh PowerBook (except the power adapter) and restart it.**

Note: If you’re connected to a network, contact your network administrator or warn other users before disconnecting from the network, because it may interrupt network services.

If the problem does not recur, it is likely related to equipment connected to your PowerBook.

- 2 Shut down the Macintosh PowerBook.**
- 3 Reconnect one device.**
- 4 Make sure that the device is plugged into a working outlet and turned on, if applicable.**
- 5 Start up the Macintosh PowerBook.**
- 6 Repeat steps 2–5 until the problem recurs. The last device you connected may be causing the problem.**

Problems with networks and file sharing

Solutions to common problems

If you are having problems using the network or file sharing, try the following before attempting further solutions:

- Make sure that AppleTalk is turned on in the Chooser.
- Open the AppleTalk or TCP/IP control panel and make sure the correct network connection is selected.
- Whenever you make a change in the AppleTalk or TCP/IP control panel, be sure to close that control panel so that the change takes effect.
- Make sure that all the network software is installed. If you aren't certain that all networking software is installed, you can use the Custom option of the Installer program on the CD that came with your computer to reinstall all network software.
- Make sure the network is working by opening the Chooser and checking for the shared disks and printers you usually use.
- Try connecting to the network from a different location, or connecting a printer or another computer directly to the PowerBook using network cables. If that works, the problem is likely to be in the network. If it doesn't work, the problem may be in the PowerBook or its network software.

Solutions to other problems

The computer you want to connect to doesn't appear in the Chooser.

- Make sure the computer you're trying to connect to is turned on.
- Make sure file sharing is active on the computer you're trying to connect to. (That computer's File Sharing control panel should say that file sharing is on.)

You connected to another computer, but the shared disk you want to use is not available.

- You may already be connected to the shared disk. Check for its icon on your desktop.
- You may not have the access privileges you need to use the shared disk. Ask the network administrator or the owner of the shared item to give you access. (See the "Sharing Files" topic area of Mac OS Help, available in the Help menu.)

You connected to another computer, but you can't see any files.

- Make sure that files are being shared on the other computer. The File Sharing control panel on that computer lists the items being shared.
- Make sure you have the access privileges you need to view the files. Ask the network administrator or the owner of the shared item to give you access. (See the “Sharing Files” topic area of Mac OS Help, available in the Help menu.)

A message says that a disk can't be ejected because it's being shared.

When you have file sharing turned on, you can't eject disks (other than floppy disks) that were connected to your computer when you started it up. You can eject the disk by turning off file sharing in the File Sharing control panel. After you've ejected the disk, you can turn file sharing back on.

A message says that file sharing can't be turned on.

- Make sure AppleTalk is turned on in the Chooser.
- Make sure you have at least 1 MB of available space on your hard disk.
- Some disk-formatting programs don't work with file sharing. If you use such a program, contact the manufacturer or vendor for compatibility information.
- There may be a problem with some of the information your computer uses to start up file sharing. Follow these steps in order until the problem is solved:
 1. Open the File Sharing control panel and enter new information in the Owner section. Then try again to turn on file sharing.
 2. Remove the File Sharing folder from the Preferences folder (inside the System Folder). Then restart the computer and try to turn on file sharing.
 3. Reset the parameter RAM. (For instructions, see “The Computer Makes an Unusual Sound at Startup, or You See a ‘Sad Macintosh’ Icon,” in the section “Problems Starting Up the Computer” earlier in this chapter.) Afterward, make sure to turn AppleTalk back on and select the correct network type in the Network control panel.
 4. Remove the Users & Groups data file from the Preferences folder (inside the System Folder). Restart the computer.
 5. Reinstall system software.

A message says that an item can't be shared.

- Make sure you have at least 1 MB of space available on your hard disk.
- Some removable storage devices can't be shared. Check with the manufacturer or vendor of the device for more information.
- Some disk-formatting programs don't work with file sharing. If you use such a program, check with the program's manufacturer or vendor.

The file-sharing section doesn't appear in the File Sharing control panel.

- You may have turned off AppleTalk or file sharing using the Extensions Manager control panel or the Chooser. Turn them back on.
- If the file-sharing and network software is not in your System Folder, use the CD that came with your computer to reinstall file-sharing and network software.

You can't open a shared disk or folder.

- You may not have the access privileges needed to use the disk or folder. Ask the network administrator or the owner of the shared item to give you access.
- Check with the owner of the item to make sure you are entering your name exactly as specified by the owner (including spaces and capitalization) and try again.

Problems with Apple Remote Access

The Remote Access Setup control panel won't open.

- Make sure that AppleTalk is turned on in the Chooser.
- If you still can't open the control panel, reinstall the Apple Remote Access software.

The modem is not listed in the Remote Access Setup control panel.

- Reinstall the modem software. If that doesn't help, then reinstall the Apple Remote Access software.
- If you are using a PC Card modem, make sure the modem file for your modem is in the Modem Scripts folder inside the Extensions folder (in the System Folder). If it is not, check the software that came with your modem. If you locate a file for your modem, put it in the Modem Scripts folder.
- Contact the modem manufacturer to see whether your modem can use the settings for another type of modem.

The modem didn't dial the phone number.

- Check that the phone cord is plugged into the computer and into a working phone line.
- Try dialing the number again. Sometimes there is a temporary connection problem.
- Quit the program and restart it. Sometimes this procedure solves temporary problems with the modem.
- Another program may be using the modem. Quit all other programs that use the modem.
- Try using another communications program. If that works, the problem may be in the Apple Remote Access software. Reinstall the software.

The modem dialed the phone number, but the connection failed.

- Check that the phone cord is plugged into the computer and into a working phone line.
- Make sure your modem is plugged into an analog phone line. Do not use a digital phone line.

IMPORTANT Digital phone lines can damage your modem.

- Check with your Apple Remote Access administrator to make sure your version of Apple Remote Access is compatible with the version on the computer you're calling. If you're using a version of Apple Remote Access later than 1.0, you can use the Remote Access Setup control panel to set your software to work with version 1.0.

You're connected via Apple Remote Access but you can't see any shared disks.

- Open the Chooser and click the AppleShare icon. Shared disks should appear on the right side of the Chooser. If you still don't see any shared disks, and your Chooser has a box labeled "Zones," choose a different zone (some networks don't have zones).
- If there are still no shared disks, or you can't connect to the one you want, contact your Apple Remote Access administrator or the owner of the computer you want to connect to.

Whenever you try to use Apple Remote Access, a message says it's not installed correctly.

- This message sometimes appears if AppleTalk is turned off. Make sure AppleTalk is turned on in the Chooser.

Consult this chapter before you call the Apple Assistance Center to solve problems with system software and your hard disk.

6

Diagnostic Techniques



This chapter provides a step-by-step approach to diagnosing and solving problems involving system software and hard disks. Try the steps listed in each section in the order they are given until your problems are fixed.

Checking your system software extensions

System software extensions are files that add features to your system software. Some extensions are incompatible with one another or with certain programs. To check whether an extension is causing problems, follow these steps:

- 1 **Start up the Macintosh PowerBook while holding down the Shift key. Keep it held down until you see the message “Extensions off” in the “Welcome to Macintosh” box.**

This procedure turns off extensions.

If this procedure solves your problem, then continue with this section. If not, then turn to the next section, “Testing Your Hard Disk.”

- 2 Restart the computer while holding down the keys Command (⌘), Option, P, and R until you hear the startup sound repeat itself three times. Then release the keys.**

This procedure resets the parameter RAM. For more information, see “The Computer Makes an Unusual Sound at Startup, or You See a ‘Sad Macintosh’ Icon,” in the section “Problems Starting Up the Computer” in Chapter 5.

If the problem does not recur, it may involve file sharing, virtual memory, or the disk cache. Turn these features back on one at a time (restarting the computer each time) until the problem recurs. You may be able to fix the problem by making the disk cache smaller or using a smaller amount of virtual memory. If the problem involves file sharing, contact your network administrator to make sure there are no network problems.

- 3 Turn off troublesome extensions using the Extensions Manager control panel.**

Tips for locating problem extensions:

- If you recently installed a new item in the System Folder, it may be causing the problem. If you recently installed a new application program, a new extension may have been installed along with it. Check for new items in the Extensions folder and Control Panels folder. Also check for items of the kind “extension” or “control panel” in the System Folder itself.
- If two of your extensions provide similar features (such as two screen savers or two clocks), they may be incompatible with each other. Remove one of the extensions.
- If the computer is freezing or displaying an error message before it finishes starting up, restart the computer and take note of the icons that appear at the bottom of the screen. Many extensions display an icon as they start up, and extensions start up alphabetically. The last extension that displays an icon, or the one after it alphabetically, may be the problem extension.

- 4 Turn extensions back on, one extension at a time, in the Extensions Manager control panel. Restart the computer after turning on each extension and test to see if the problem recurs.**

When you have located the problem extension, remove it from the System Folder and contact the developer or vendor for compatibility information.

- 5 Go to the next section if you are still having problems.**

Testing your hard disk

The following steps will help you determine whether you have a problem with your hard disk or a problem with the system software on your hard disk.

1 Start up the Macintosh PowerBook with the system software CD that came with your computer.

If the computer starts up normally, you may have a problem with the system software on your hard disk. If the computer starts up but you don't see the hard disk icon, you may have a problem with the hard disk.

If the computer doesn't start up normally, you may have a problem with equipment connected to your Macintosh PowerBook. See "Problems With Equipment Connected to Your Computer" in Chapter 5.

If nothing is connected, your computer may need repair. Contact an Apple-authorized service provider, or call the Apple Assistance Center.

2 Open the Drive Setup icon.

You may need to look in a folder called Utilities to find Drive Setup.



Drive Setup

Note: You can get onscreen help using the Drive Setup application program by choosing the Drive Setup Guide, available in the Help menu when Drive Setup is running.

3 In the list of drives, click the disk you want to test.

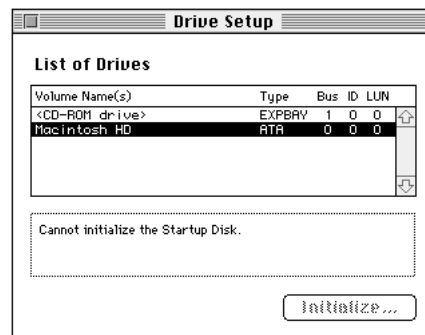

- 4 **Open the Functions menu and choose Test Drive.**
- 5 **When a message tells you that testing is complete, click Quit.**

If you cannot repair the disk, you may need to reinitialize the disk using the Drive Setup program.

WARNING Reinitializing the hard disk erases all the information on it. If you don't have a recent backup of your information, an Apple-authorized service provider may be able to recover some of the information before you reinitialize the hard disk.

- 6 **If testing indicates that no repair is necessary, but you're still having a problem with your computer, go to the next section.**

Reinstalling system software

When should you install system software?

Your computer came with all the necessary system software installed on its internal hard disk, so you don't need to install system software on that disk unless you encounter software problems.

If you have a new hard disk or a newly initialized hard disk that doesn't contain system software, or if you want to upgrade to a more recent version of system software on a hard disk, follow the instructions in "Installing Mac OS 8" later in this chapter.

If you have a problem with your system software, you may see this icon in the middle of the screen:



If this icon appears, follow the instructions in "Testing Your Hard Disk" earlier in this chapter to test your startup hard disk and repair any damage.

If repairing the disk doesn't help, follow the instructions in "Installing Mac OS 8" to reinstall system software on your startup hard disk.

Restoring custom settings and special software

Your computer came from the factory with

- additional applications
- system software settings
- the Mac OS Info Center customized for your computer

When you reinstall system software using the Mac OS 8 Install program described in this chapter, it will not reinstall bundled applications, reset customized settings, or provide customized information about your computer.

If you want to restore your computer to its custom settings, use the restore program that is included on your system software CD. Follow these steps:

- 1 Restart your computer using your system software or restore CD, as described in the next section.**
- 2 Follow the instructions in the Read Me file for more information about restoring your system software or bundled applications.**

Using a CD to start up your computer

Before you reinstall software onto your hard disk, you need to start up your computer with the CD-ROM containing system software. This allows the Mac OS Install program to repair any problems on your hard disk and update the disk driver before you install the software.

Before you begin the installation, do the following:

- Turn off any virus-protection software and disk-security software you may have.
- Plug in the power adapter and set the computer so it doesn't go to sleep.
- Turn off password protection in the Password Security control panel.

Follow these steps to start up from the CD containing system software.

- 1 Press the Open/Close button of your CD-ROM drive to open the CD-ROM tray.**
- 2 Place the CD-ROM disc containing system software in the tray with the disc label facing up.**

Make sure the disc is lying flat in the tray.

- 3 Close the CD-ROM tray by pushing in the tray or pressing the Open/Close button.**
- 4 Hold down the C key on your keyboard while you choose Restart from the Special menu and wait for the message "Welcome to Mac OS" to appear.**
- 5 When you see the screen that says "Mac OS" and the phrase "Starting Up," release the C key.**

In a few seconds the desktop appears. Your computer is now using the system software that's on the CD-ROM disc. You'll know you've started up from the CD-ROM disc if you see the CD-ROM disc icon at the top-right corner of the desktop, above your hard disk icon. The desktop pattern will also be different.

Installing Mac OS 8

After you've started up your computer using the CD-ROM disc, use the Mac OS Install program to install the software.

- 1 Double-click the Mac OS Install icon.



After a moment, a screen appears describing the four steps in the installation process.

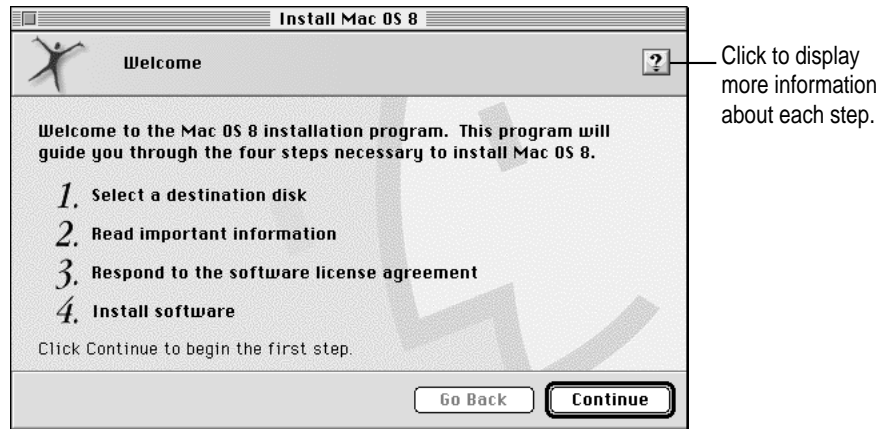

The Mac OS Install program guides you through the steps necessary to install the software. To learn more about each step, click the Help (ⓘ) button in the upper-right corner of the window.

2 When you're ready to begin, click **Continue** and follow the instructions you see on the screen.

Note: The Mac OS Install program automatically runs the applications Drive Setup and Disk First Aid before starting the installation process. Prior versions of system software required that you run these applications separately. If you need information on how to use these applications, choose Drive Setup Guide or Disk First Aid Guide when each application is running.

As part of the normal software installation process, the Mac OS Install program replaces changed system files and adds new ones, but leaves others alone. In addition, the Mac OS Install program provides an option for doing a clean installation of system software.

IMPORTANT You should only perform a clean installation if you have already tried reinstalling system software as described in this section and are still experiencing the same problems with your system. For more information on when you should do a clean installation, see “Performing a Clean Installation” later in this chapter.

Responding to messages about your hard disk

The Mac OS Install program checks the destination hard disk for errors before installing the software. If your hard disk was formatted with an Apple disk utility program, the Installer updates the hard disk drivers with the latest version of the driver software. If your disk was formatted with a disk utility from another company, the drivers are not updated. You should use the third-party disk utility to update your hard disk before installing Mac OS 8.

Selecting which software to install

The Mac OS Install program installs the basic components of the system software along with additional software features such as QuickDraw 3D and Personal Web Sharing.



After you select a drive for installation, you will see these choices:

- Reinstall Mac OS 8

Select this option if you need to reinstall system software to solve system software problems or repair a damaged hard disk. This process is known as a standard installation. If you select this option, go to the next section, “Select Software to Install Using a Standard Installation.”

- Add or remove software features

Select this option if you want to install specific components of Mac OS 8 or additional software features. You can also use this option to selectively remove software components. This process is known as a custom installation. If you select this option, skip ahead to the section “Select Software to Install or Remove Using a Custom Installation.”

For most computer users, the standard installation is best, because it automatically installs everything you need for your model of computer. However, if you'd like to select only the software specific to your needs, you can customize your installation. You can install or update one or more specific files, or save space on your hard disk by installing only the files you want.

Select software to install using a standard installation

The next step in the installation process is to select the software that you want to install along with Mac OS 8.

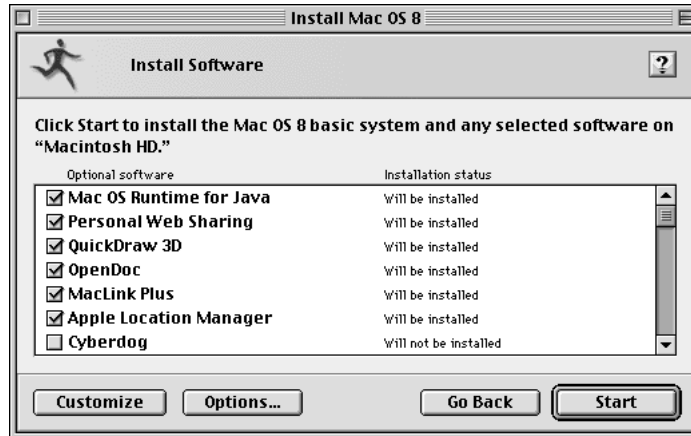

1 Select the software to install along with Mac OS 8.

The Install Mac OS 8 window provides a list of items that you can select or deselect. Boxes that are already selected are those items that are normally installed as part of the Mac OS.

2 Click Start.

Mac OS 8 along with any additional software you selected is now installed on your computer.

3 After you've installed all the software you selected, restart your computer.

Select software to install or remove using a custom installation

The next step in the installation process is to select the software that you want to install along with Mac OS 8.

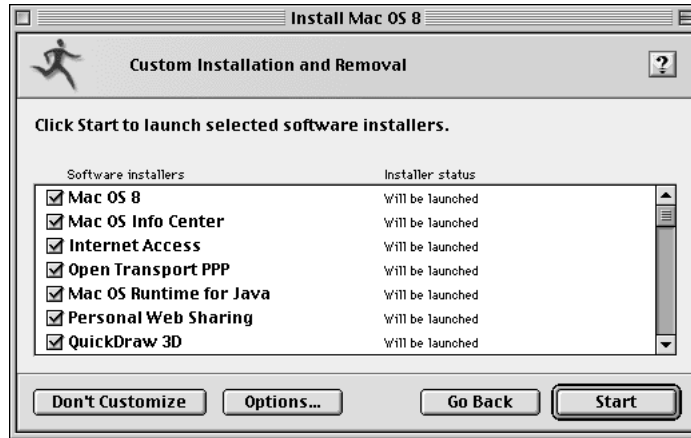

1 Select the software to install, the software to remove, or both.

As you proceed in the custom installation process, you'll be able to determine exactly which components will be installed or removed for the software you select.

When performing a custom installation you can choose whether to install Mac OS 8. If you select Mac OS 8, you will be able to add or remove specific components of Mac OS 8, such as fonts and printer drivers.

2 Click Start.

The Installer for the first software product you selected appears. You'll use the Installer to specify which components of the product you want to install.

3 When you see the Installer's welcome screen, click Continue.

If you want all the recommended components for this product, click Install. Then skip to step 8.

If you want to install specific components of the software, or remove the software, follow steps 4 through 6 below.

- 4 **Open the pop-up menu and choose a menu item.**
 - If you want to install software, choose Custom Install.
 - If you want to remove software, choose Custom Remove.



All available components for the software product appear in the Installer's window.

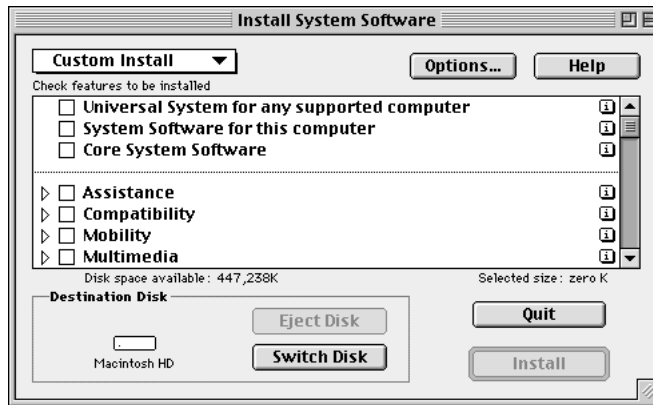

- 5 **Scroll through the list of components and click the checkbox next to each component you want to install or remove.**

You can see and select individual items within each component by clicking the arrow to the left of the component, then clicking the item you want to install. To get additional information about each component listed, click the box with the letter *i* in it to the right of the component.

6 Click Install or Remove.

If you are installing software, the selected items will be installed on your computer. If you are removing software, the selected items will be deleted from your computer.

The Installer may also remove or delete associated files that are required for the items you choose.

7 Repeat steps 4 through 6 for all the software you selected.

After you finish installing or removing a software product, the Installer for the next product you selected opens automatically.

8 After you've installed all the software you selected, restart your computer.

Problems during installation

This section helps you solve problems you may encounter while installing your software.

You can't start up the computer using the system software CD-ROM disc.

Cause: Your computer located the system software on your hard disk before it located the system software on the CD. If you have an external hard drive with system software, the computer may have started up from that device instead of the CD-ROM disc.

Solution: With the CD in the drive, open the Startup Disk control panel and click the CD icon. Then restart the computer.

You'll need to reselect your hard disk as the startup disk after you install the software. Open the Startup Disk control panel again and click the icon for your hard disk. Then restart your computer.

The Installer cannot repair your hard disk.

Cause: The Mac OS Install program is unable to repair a problem with your hard disk.

Solution 1: If you see a message that the disk can't be fixed because a file is open or file sharing is on, make sure that you have started up your computer from the system software CD. See "Using a CD to Start Up Your Computer" earlier in this chapter.

Solution 2: Use a third-party disk repair utility to repair the disk.

If you don't have a third-party utility, or if that utility can't repair the disk either, you may need to reinitialize the hard disk.

First, back up your hard disk because reinitializing erases everything on the disk. Then use the Drive Setup utility program to reinitialize the disk. If your hard disk is not an Apple hard disk, use the disk utility software provided by the manufacturer instead of Drive Setup.

You can find Drive Setup in the Utilities folder on your system software CD-ROM disc. To reinitialize your startup disk (the disk with system software on it), you need to start up the computer from a different disk. You can start up using your system software CD-ROM disc. See "Using a CD to Start Up Your Computer" earlier in this chapter for instructions.

After you've reinitialized the disk, use the Mac OS 8 Install program to reinstall system software. Then reinstall your application programs.

You see a message that there's not enough disk space.

Cause: Your computer's hard disk has less than the minimum amount of space required to install the software.

Solution: Make more space available on your hard disk by removing some files from the disk. Make backup copies of the files, if desired. Then drag them to the Trash and choose Empty Trash from the Special menu. You don't need to quit the Installer before you remove the files from the disk.

When you see this message, some of the software you selected may have been installed. The Install Software window in the Installer program indicates which software has already been installed.

You see a message that the System file cannot be modified.

Cause 1: You have installed virus-protection software that guards against modification of the System file.

Solution 1: Start up your computer from your system software CD-ROM disc as described in “Using a CD to Start Up Your Computer” earlier in this chapter.

Solution 2: Drag any virus-protection software out of the System Folder and restart your computer. You can put the virus-protection software back after installation.

Cause 2: The System and Finder files may be locked.

Solution: Make sure that you have started up from the CD. Then, to see if your System file or Finder file is locked, select the file’s icon. Then open the File menu and choose Get Info. To unlock the file, click the Locked checkbox to remove the mark.

Performing a clean installation

This section provides instructions for what is commonly called a *clean installation* of system software.

A normal system software installation replaces changed system files and adds new ones, but leaves other files alone. When you install system software using a clean installation, the Installer creates a new System Folder on your hard disk. The old System Folder is renamed Previous System Folder. Since your computer has a new System Folder, you must reinstall any third-party extensions and control panels after a clean installation. Application programs and documents are not replaced or changed.

Performing a clean installation can be a complicated procedure, but if you are experiencing problems or your computer seems slow, it may help.

If your computer came with software that was already installed, some of those programs might need to be reinstalled after you perform a clean installation. See the printed or electronic manuals that came with the software for information.

Follow these steps to perform your clean installation.

- 1 **Start up your computer from your system software CD-ROM disc, as described in “Using a CD to Start Up Your Computer” earlier in this chapter.**
- 2 **Open the Mac OS Install program.**
- 3 **In the Welcome dialog box, click continue.**

The Select Destination dialog box appears.



- 4 **Click the Perform Clean Installation checkbox so that it has a mark in it.**
- 5 **Click Select.**
- 6 **Select the software products you want to install.**

For more information about the choices available, or for instructions on further customizing your selections, see “Selecting Which Software to Install” earlier in this chapter.

- 7 **Click Start to install the software you’ve selected.**

A new System Folder is installed on your hard disk. (The old System Folder is renamed Previous System Folder.)

When the Mac OS Installer is finished, you can reinstall extensions, fonts, control panels, and other items not installed with Mac OS 8 from their original disks. If you don't have the original disks, you can drag or copy these items one at a time from the Previous System Folder to the new System Folder. Restart your computer after you reinstall each item to make sure the software is compatible with Mac OS 8.

After you're sure that you've copied all the items you want to save into your new System Folder, delete the Previous System Folder from your hard disk.

Refer to this appendix for important health-related information and safety tips.



Appendix A Health, Safety, and Maintenance Tips



Health-related information about computer use

Muscle soreness, eye fatigue, and other discomforts and injuries sometimes associated with using computers can occur from performing any number of activities. In fact, misuse of the same muscles during multiple activities can create a problem that might not otherwise exist. For example, if you engage in nonwork activities that involve repetitive stress on the wrist—such as bicycling—and also use your computer’s keyboard improperly, you may increase your likelihood of developing wrist problems. Some individuals are at greater risk of developing these problems because of their health, physiology, lifestyle, and general exposure to stress. Work organization and conditions, such as workstation setup and lighting, also play a part in your overall health and comfort. Preventing health problems is a multifaceted task that requires careful attention to the way you use your body every hour of every day.

The most common health effects associated with using a computer are musculoskeletal discomfort and eye fatigue. We’ll discuss each area of concern in this appendix.

Musculoskeletal discomfort

As with any activity that involves sitting for long periods of time, using a computer can make your muscles sore and stiff. To minimize these effects, set up your work environment carefully, using the guidelines that follow, and take frequent breaks to rest tired muscles. To make working with your computer more comfortable, allow enough space in your work area so that you can change position frequently and maintain a relaxed posture.

Another type of musculoskeletal concern is repetitive stress injuries (RSIs), also known as cumulative trauma disorders (CTDs). These problems can occur when a certain muscle or tendon is repeatedly overused and forced into an unnatural position. The exact causes of RSIs are not totally understood, but in addition to awkward posture, such factors as the amount of repetition, the force used in the activity, the individual's physiology, workplace stress level, and lifestyle may affect the likelihood of experiencing an RSI.

RSIs did not suddenly arise when computers were invented; tennis elbow and writer's cramp, for example, are two RSIs that have been with us for a long time. Although less common than other RSIs, one serious RSI discussed more often today is a wrist problem called carpal tunnel syndrome, which may be aggravated by improper use of computer keyboards. This nerve disorder results from excessive pressure on the median nerve as it passes through the wrist to the hand.

This section offers advice on setting up your work area to enhance your comfort while you use your computer. Since the effects of repetitive movements associated with using a computer can be compounded by those of other work and leisure activities to produce or aggravate physical problems, proper use of your computer system must be considered as just one element of a healthy lifestyle.

No one, of course, can guarantee that you won't have problems even when you follow the most expert advice on using computer equipment. You should always check with a qualified health specialist if muscle, joint, or eye problems occur.

Eye fatigue

Eye fatigue can occur whenever the eyes are focused on a nearby object for a long time. This problem occurs because the eye muscles must work harder to view an object that's closer than about 20 feet (6 meters). Improper lighting can hasten the development of eye fatigue. Although eye fatigue is annoying, there's no evidence that it leads to permanent damage.

Whenever you're engaged in an activity that involves close-up work—such as reading a magazine, doing craft work, or using a computer—be sure to have sufficient glare-free lighting and give your eyes frequent rest breaks by looking up and focusing on distant objects. Remember to have your eyes examined regularly.

To prevent discomfort and eye fatigue:

- Arrange your work space so that the furniture is properly adjusted for you and doesn't contribute to an awkward working posture.
- Take frequent short breaks to give your muscles and eyes a chance to rest.

Arranging your work area and equipment

The suggestions in this section can help you work more comfortably with your computer.

Chair

- An adjustable chair that provides firm, comfortable support is best. Adjust the height of the chair so your thighs are horizontal and your feet flat on the floor.

The back of the chair should support your lower back (lumbar region). Follow the manufacturer's instructions for adjusting the backrest to fit your body properly.

Keyboard and trackpad

- When you use the keyboard and trackpad, your shoulders should be relaxed. Your upper arm and forearm should form an approximate right angle, with your wrist and hand in roughly a straight line.

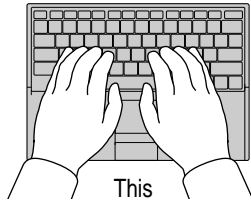

- You may have to raise your chair so your forearms and hands are at the proper angle to the keyboard. If this makes it impossible to rest your feet flat on the floor, you can use a footrest with adjustable height and tilt to make up for any gap between the floor and your feet. Or you may lower the desktop to eliminate the need for a footrest. Another option is to use a desk with a keyboard tray that's lower than the regular work surface.
- Use a light touch when typing or using the trackpad and keep your hands and fingers relaxed. Avoid rolling your thumbs under your palms.

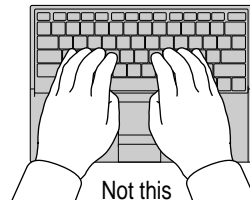
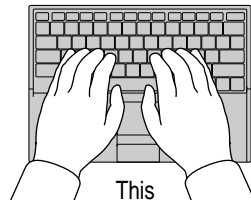

Some computer users may develop discomfort in their hands, wrists, or arms after intensive work without breaks. If you begin to develop chronic pain or discomfort in your hands, wrists, or arms, consult a qualified health specialist.

- Change hand positions often to avoid fatigue.
- If you prefer, you can adjust the angle of the keyboard by lowering the elevation feet until they snap into position.

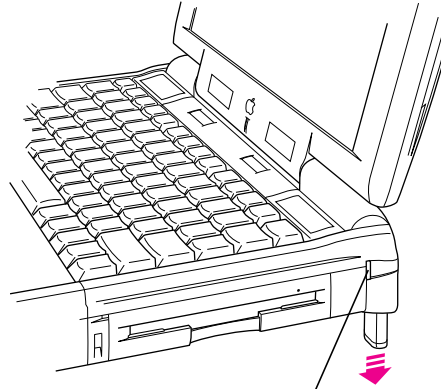

To lower the foot, press the release button. The foot extends automatically.

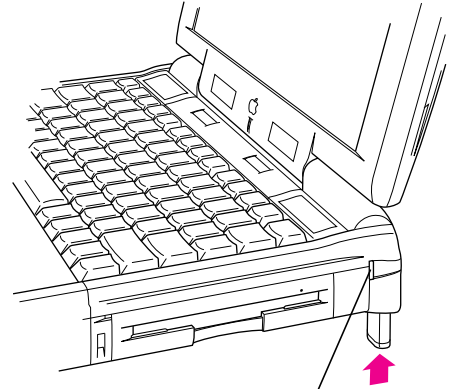

To raise the foot, press the release button while pushing up on the foot until it clicks into place.

The back of the keyboard is slightly elevated when the feet are in use. Otherwise, the keyboard is level.

Mouse

- If you use an external mouse, position the mouse at the same height as your keyboard. Allow adequate space to use the mouse comfortably.

Built-in display

- Adjust the angle of the display to minimize glare and reflections from overhead lights and windows.
- You may need to adjust the brightness and contrast of the screen when you take the computer from one work location to another, or if the lighting in your work area changes.

External monitor

If you use an external monitor, this suggestion may be helpful.

- If possible, arrange the monitor so the top of the screen is slightly below your eye level when you're sitting at the keyboard. The best distance from your eyes to the screen is up to you, although most people seem to prefer 18 to 28 inches (45 to 70 cm).

Avoiding fatigue

- Change your seated position, stand up, or stretch whenever you start to feel tired. Frequent short breaks are helpful in reducing fatigue.
- Allow adequate work space so that you can work comfortably. Place papers or other items so you can view them easily while using your computer. A document stand may make reading papers more comfortable.
- Eye muscles must work harder to focus on nearby objects. Occasionally focus your eyes on a distant object, and blink often while you work.
- Clean your screen regularly. Keeping the screen clean helps reduce unwanted reflections.

What about electromagnetic emissions?

There has been recent public discussion of the possible health effects of prolonged exposure to extremely low frequency (ELF) and very low frequency (VLF) electromagnetic fields. Such fields are associated with electromagnetic sources such as television sets, electrical wiring, and some household appliances—as well as computer monitors.

Apple has reviewed scientific reports and sought the counsel of government regulatory agencies and respected health organizations. Based on the prevailing evidence and opinions, Apple believes that the electric and magnetic fields produced by computer monitors do not pose a health risk.

In response to those customers who wish to reduce their exposure to electromagnetic fields, Apple has lowered the emission levels of its products.

Important care and safety instructions

For your own safety and that of your equipment, read and follow all the instructions in this section. Keep these instructions available for reference by you and others.

Warning

- Electrical equipment may be hazardous if misused. Operation of this product, or similar products, must always be supervised by an adult. Do not allow children access to the interior of any electrical product and do not permit them to handle any cables.
- Do not use the computer in or near water.
- Do not use cables that are frayed or otherwise damaged. Hold a cable by its connector (the plug, not the cord) when connecting or disconnecting it.
- Always handle batteries carefully.
- Do not drop, puncture, mutilate, or burn the computer or battery.
- Transport batteries either inside the computer or with the protective cap covering the battery contacts.

Caution

- If you have a problem with your computer and nothing in the computer manual solves the problem, take the computer to your Apple-authorized dealer or service provider. Attempting to repair the computer yourself may void the limited warranty.
- Do not move the computer when you can hear its hard disk spinning. When you put the computer to sleep, wait until the screen is blank before moving the computer.
- Never force a connector into a port. Make sure that the connector matches the port and that it's right side up. If the connector and port do not join easily, they do not match.
- Do not use the computer in wet or dusty environments.

- Keep dirt and liquids away from the ports on the back panel, the keyboard, and the trackpad. If you spill any food or liquid onto the computer, shut it down immediately and unplug it before cleaning up the spill. Depending on what you spilled and how much got into the computer, you may have to bring the computer to an Apple-authorized service provider for cleaning.
- Do not touch the screen with any sharp or pointed objects.
- Use only the battery supplied with your computer, or an identical model. Batteries designed for other portable computers may look similar, but they may not work with your computer and may damage it.
- Use only the power adapter supplied with your computer, or an identical model. Adapters designed for other electronic devices may not work with your equipment and may damage it.

Important

- Use the computer only in environments where the temperature range is between 50° F/10° C and 95° F/35° C.
- Do not expose the computer to very low (less than -13° F/-25° C) or very high (more than 140° F/60° C) temperatures.
- If the computer has been in a cold place for several hours, let it warm up to room temperature before you use it.
- Clean the computer's outside surfaces with a damp (not wet) cloth. Clean the screen with soft, lint-free paper or cloth and a mild glass cleaner. Do not spray the glass cleaner directly onto the screen.

Caring for batteries

Always handle batteries carefully.

- Always put the battery cap on the battery when the battery is out of the Macintosh PowerBook. The battery contacts should not be exposed when the battery is out of the computer.
- Never get batteries wet.
- Do not short-circuit the battery terminals (that is, do not touch both terminals with a metal object). Doing so may cause an explosion or a fire.

- Do not drop, puncture, disassemble, mutilate, or incinerate the battery.
- Recharge batteries only as described in this manual and only in ventilated areas.
- Do not leave batteries in hot locations (such as the trunk of a car).
- Do not leave a battery in your computer for longer than a week without plugging in the power adapter.
- Do not leave a battery in storage for longer than six months without recharging it.
- Take dead batteries to an Apple-authorized service provider for recycling or proper disposal. The batteries contain hazardous chemicals and should not be thrown out with household or office trash.

Handling floppy disks

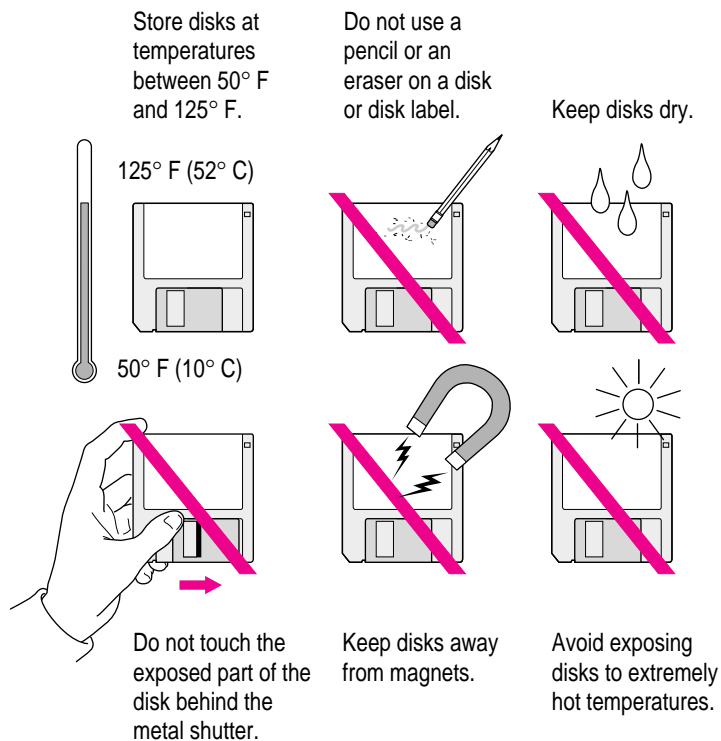

Traveling with the Macintosh PowerBook

IMPORTANT Always take the CD that came with your computer with you when you travel. If you experience system software problems while traveling, you may need these disks to correct any problem.

Airplanes and airports

Some airlines have reported that use of portable electronic devices may have interfered with the aircraft's flight navigation or communications systems. Many airlines restrict or manage the use of electronic equipment during flights. Please respect the regulations of the airlines.

A properly tuned X-ray machine should cause no damage to your Macintosh PowerBook. But the motors that drive the belts on some security machines have magnets that can damage your information. To avoid problems, place the Macintosh PowerBook close to the entrance of the machine and remove it as soon as possible. At most airports you can also have the computer hand-inspected by security personnel.

Metal detectors should not damage the Macintosh PowerBook.

Security officials may require you to turn the Macintosh PowerBook on. Make sure you have a charged battery on hand.

Handling your Macintosh PowerBook

The safety instructions earlier in this appendix also apply when you are traveling. In addition, note these precautions:

- Do not transport your Macintosh PowerBook while it is turned on. Put your computer to sleep or shut it down before you move it.
- Transport batteries either inside the computer or with the protective cap covering the battery contacts. Do not transport unprotected batteries.
- Do not check your computer as baggage. Carry it with you.
- Take the necessary plug adapters if you're traveling overseas. (You may need to use them with the power cord.) You do not need a voltage transformer. The power adapter can handle 90 volts to 260 volts AC (48 Hz to 62 Hz).

Check the diagrams below to determine which plug adapters you'll need, or ask your travel agent.

| Outlet type | Locations |
|---|---|
|  | United States, Canada, parts of Latin America, Japan, Korea, the Philippines, Taiwan |
|  | Russia and the Commonwealth of Independent States (CIS), most of Europe, parts of Latin America, the Middle East, parts of Africa, Hong Kong, India, most of South Asia |
|  | Mexico, United Kingdom, Ireland, Malaysia, Singapore, parts of Africa |
|  | China, Australia, New Zealand |

International repair and service

Apple's global limited warranty covers your Apple products for one year, regardless of where the products are purchased. The Apple-authorized service providers in more than 80 countries can handle most repairs (unless the repair involves a component specific to another area of the world). Bring a copy of your proof of purchase with you.

Because of variations in environment and power supplies, Apple is not responsible for damage to Apple products used outside the United States.

Storing the Macintosh PowerBook

- 1 **Save your work on a hard disk or floppy disks.**
- 2 **Make sure the battery is fully charged.**
- 3 **Press the Power key and click Shut Down, or choose Shut Down from the Special menu.**
- 4 **Close the display.**
- 5 **Store the computer in a cool, dry place.**

Storage temperatures should remain between -25°C and 60°C (between -13°F and 140°F). Avoid leaving the computer where temperatures may be extreme or unpredictable—in the trunk of a car, for example.

Service and support

If your computer is malfunctioning but does not appear to be physically damaged, shut it down (and leave the power adapter plugged in, if possible) until you can get help.

If you know or suspect that your computer is physically damaged, disconnect the power adapter, remove the battery, and do not use the computer until it can be repaired.

See the service and support information that came with your computer for information about customer assistance.

Refer to this appendix
for information on using your
Macintosh PowerBook keyboard.



Appendix B Using Your Keyboard



The keyboard on your Macintosh PowerBook computer works in much the same way as the keyboards on other computers and on electric typewriters. However, there are a few special keys you should know about. Many of these keys allow you to give commands to the computer without using the trackpad. For example, in many application programs, you can press the ⌘ (Command) key at the same time as the Q key to quit a program.

The illustration on the following page explains the function of all the special keys on the keyboard of your Macintosh PowerBook computer.

Special keys on the Macintosh PowerBook keyboard

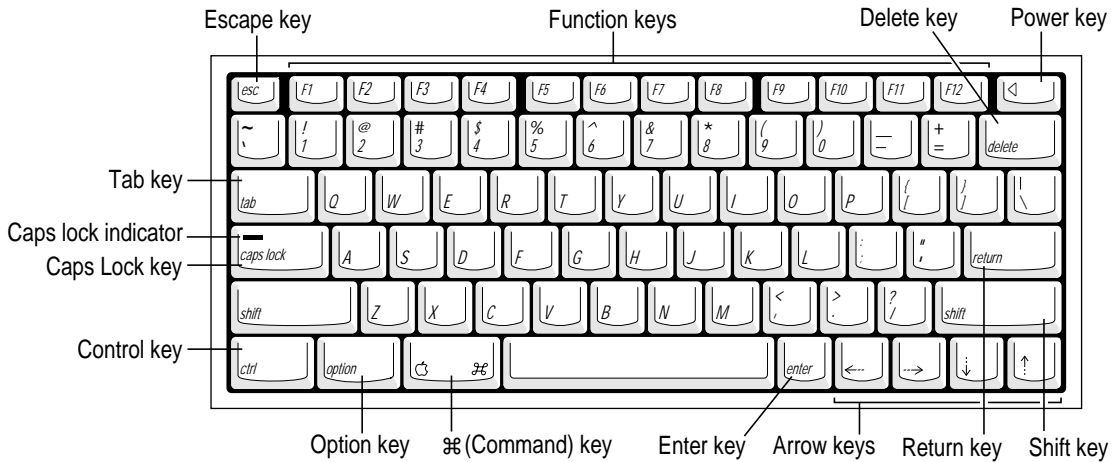

| | |
|------------------------|--|
| Arrow keys | Move the insertion point as an alternative to using the pointing device. In some programs, the arrow keys have other functions. |
| Caps Lock key | A locking Shift key for letters only (numbers and symbols aren't affected). A small green light shows on the Caps Lock key when caps lock is on. |
| ⌘ (Command) key | Works in combination with other keys as an alternative to choosing a menu command. |
| Control key | In combination with other keys, provides shortcuts or modifies actions. |
| Delete key | Deletes selected material, or the character to the left of the insertion point. |
| Enter key | In a dialog box, pressing Enter is the same as clicking the outlined button. In some programs, confirms information you have provided. |
| Escape key | The function of this key depends on the program you're using. |
| Function keys | Some programs allow you to use function keys to give commands. You can assign commands or action sequences to function keys with utility programs. |
| Option key | In combination with other keys, produces special characters or modifies actions. |
| Power key | Turns the computer on and off. |
| Return key | Moves the insertion point to the beginning of the next line. In a dialog box, pressing Return is the same as clicking the outlined button. |
| Shift key | Produces capital letters (or the upper character on the key). |
| Tab key | Moves the insertion point to the next stopping place (such as a tab stop or data field). |

Typing special characters and symbols

You can type a variety of international and other special symbols and characters (including characters with diacritical marks, such as accents) by pressing combinations of keys.

The Key Caps program, which is installed with your system software, shows you the characters produced when you type certain keys and key combinations in the fonts available on your computer. Choose Key Caps from the Apple (🍏) menu, then choose the font from the Key Caps menu.



To have Key Caps show more options for special characters, press each of these keys or key combinations: Option, Shift, Shift-Option, Shift-⌘, and Option-⌘.

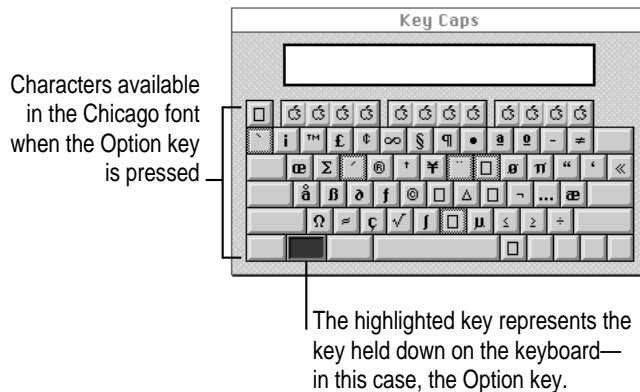

If you press the Option key, Key Caps outlines lightly the keys that you can use in combination with letter keys to type letters with accents or other diacritical marks.

If you see rectangles: If you see rectangles instead of diacritical marks on some of the pictures of keys in Key Caps, try pressing Option-⌘ to see the diacritical marks. However, you only need to use the Option key (not Option-⌘) in combination with the other keys to type letters with diacritical marks.

If you press the Option key at the same time as a key for a specific diacritical mark and then release both keys, Key Caps outlines in bold the keys for letters that can be typed with that mark. (You'll see that most key combinations for diacritical marks can be used with the Space bar as well as letter keys—producing the mark without a letter.)

The most common diacritical marks and how to create them are summarized next.

| Diacritical mark | Key combination |
|-------------------------------------|-----------------------------------|
| Grave accent (`) | Option-`, then type the character |
| Acute accent (´) | Option-e, then type the character |
| Circumflex (^) | Option-i, then type the character |
| Tilde (~) | Option-n, then type the character |
| Umlaut (¨) | Option-u, then type the character |
| The letter “c” with a cedilla (ç) | Option-c |

- **To type a letter or a space with a specific diacritical mark, press the Option key and the key for the mark simultaneously. Then type the letter that needs the mark.**

If you are having trouble getting a mark and letter to appear together, try again. Be sure to press the Option key before (or at the same time as) the key for the mark; then, after you release both keys, type the letter to be marked.

Special key combinations

If difficulties with your trackpad or computer don't allow you to use standard methods of quitting a program or restarting your computer, you can try using these special key combinations.

| To do this... | ...press this key combination |
|-------------------------------|-------------------------------|
| Force a program to quit | ⌘-Option-Esc |
| Force the computer to restart | ⌘-Control-Power key |

Here are other key combinations you may find useful.

| To do this... | ...press this key combination |
|---|--|
| Start a “debugging” application used by software programmers* | ⌘-Power key |
| Rebuild desktop | Shift key (while starting up); release, then hold Option-⌘ |

*If you do not have a debugging program installed, your screen displays a right angle-bracket prompt (>). To return to the desktop, press G, then press Return.



Refer to this appendix for instructions
on installing a Macintosh PowerBook
RAM expansion card.



Appendix C Installing a Macintosh PowerBook RAM Expansion Card



You can purchase a RAM card to augment your PowerBook's operation.

Note: You should attempt to install a RAM card only if you are comfortable working with electronic equipment. You should read all of the following instructions before you begin. If the procedure sounds like something you don't want to do yourself, any Apple-authorized service provider can install the card for you (for a service charge).

WARNING If you attempt to install a RAM card yourself, any damage you may cause to your equipment will not be covered by the limited warranty on your computer. See an Apple-authorized dealer or service provider for additional information about this or any other warranty question.

Getting ready

You will need the RAM expansion card and a screwdriver with a Torx T-8 head. (Your card may come with a Torx T-8 screwdriver. If you need to purchase a Torx T-8 screwdriver, you can probably find one at a hardware or electronics supply store.)

IMPORTANT No other type of screwdriver can be used to install the RAM card in your Macintosh PowerBook.

Make sure you are installing a RAM card made for your Macintosh PowerBook computer. You can't install a card made for another PowerBook model, such as the 5300 series, in your computer. The RAM card must use low-profile memory chips.

Some RAM cards made for PowerBook 3400 series computers may be compatible with your PowerBook, but not all cards are compatible. Check with the card's vendor to be certain that the card is compatible with your PowerBook computer. The RAM card available from Apple for PowerBook 3400 series computers is compatible with your PowerBook.

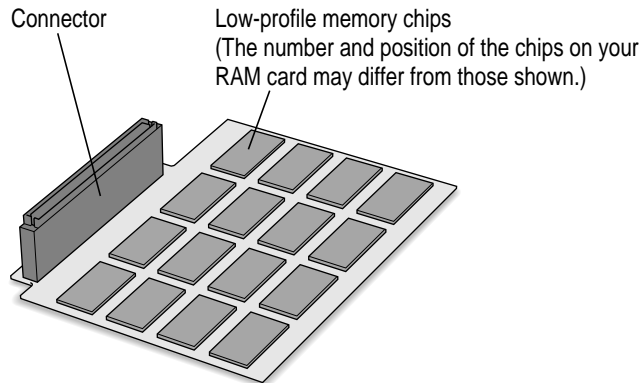

Installing the card

To install the RAM expansion card, follow these steps:

- 1** Disconnect all cables from the computer, including the power adapter. Make sure the computer is turned off.
- 2** Close and latch the display.

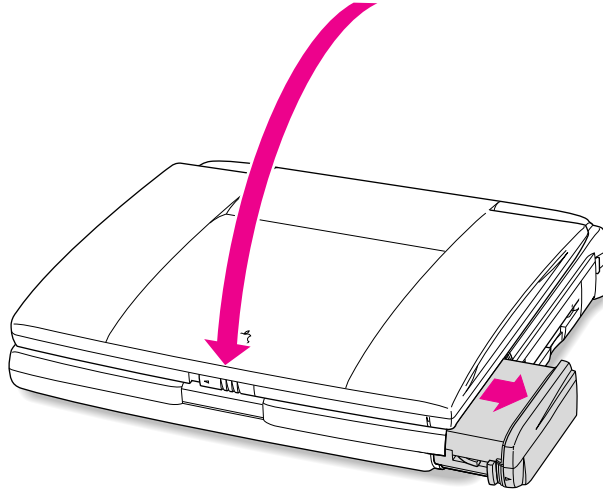

- 3** Remove the battery from the computer.

If you're unfamiliar with this procedure, follow the instructions in “Removing or Replacing the Battery” in Chapter 4.

4 Turn the computer over and unscrew the three screws on the bottom of the computer.

These screws can only be loosened with a Torx T-8 screwdriver.

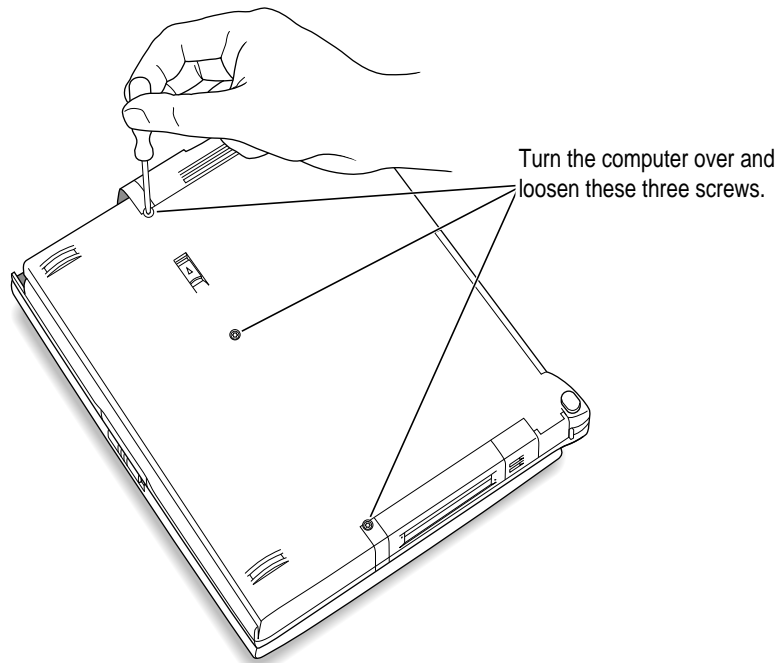

- 5** Lift up the computer and carefully turn it over to remove the three loosened screws.

Set the screws aside.

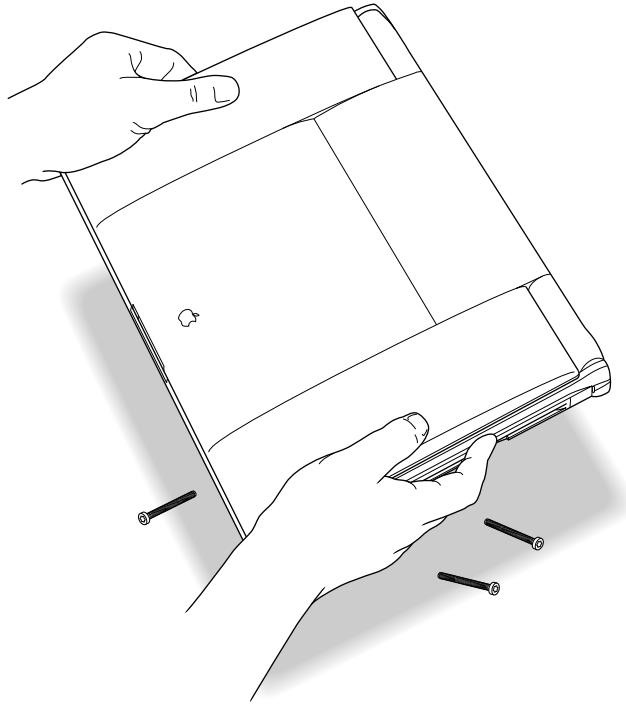

- 6 Set the computer down and open the display to its maximum angle.

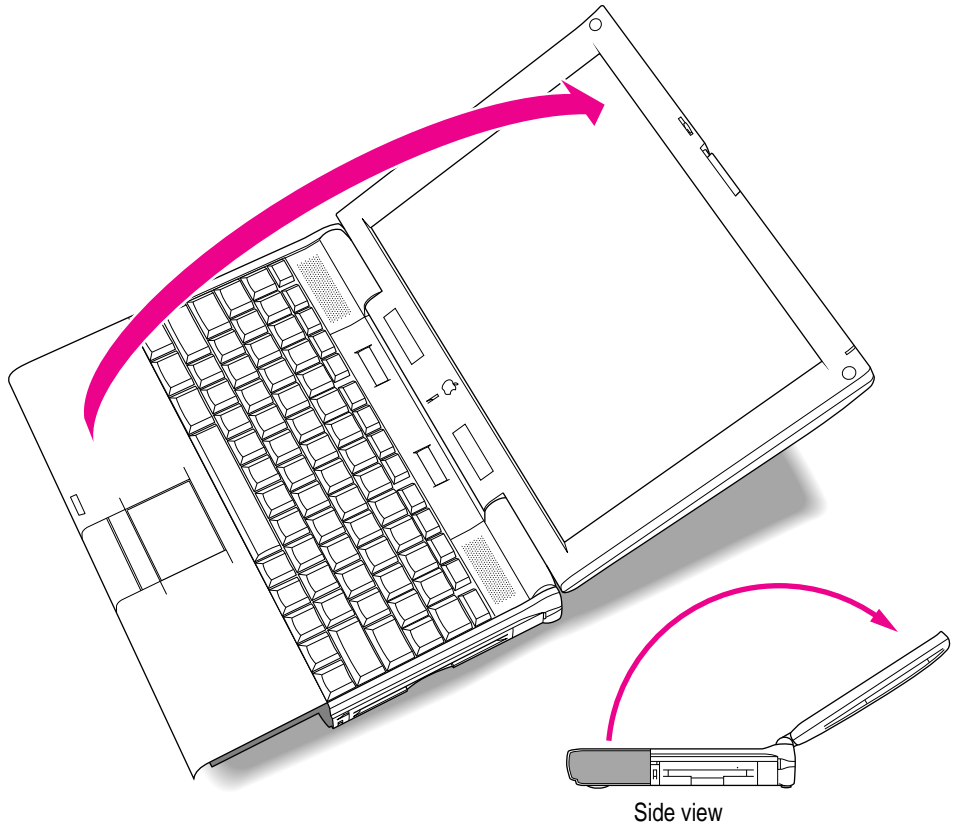

7 Gently lift the side panels of the computer a short distance.

Be careful not to lift too far. A slight lift should raise the keyboard enough for you to grasp it.

Gently lift the side panels of the computer up a short distance (approximately 1/4"). You don't want to remove the side panels; you only want to raise the keyboard slightly so that you can grasp the keyboard with your fingers and be able to lift it out of the computer.

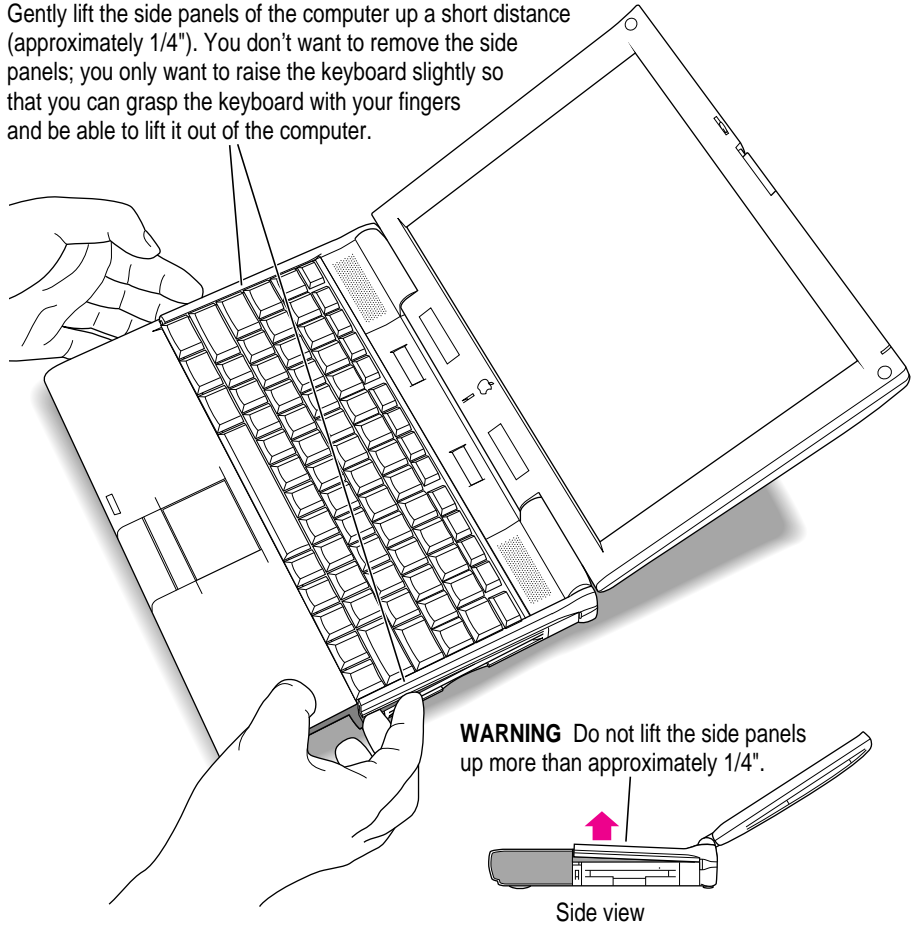

- 8** Carefully pull the keyboard forward to loosen the four tabs at the top. Be very careful to avoid pulling the keyboard out too far. The cable attaching the keyboard to the computer is very short.

Gently slide the keyboard away from the display a short distance to disengage these tabs.

WARNING Don't pull the keyboard away from the display more than 3/8". If you pull the keyboard away from the display more than 3/8", you may pull this cable out of its socket.

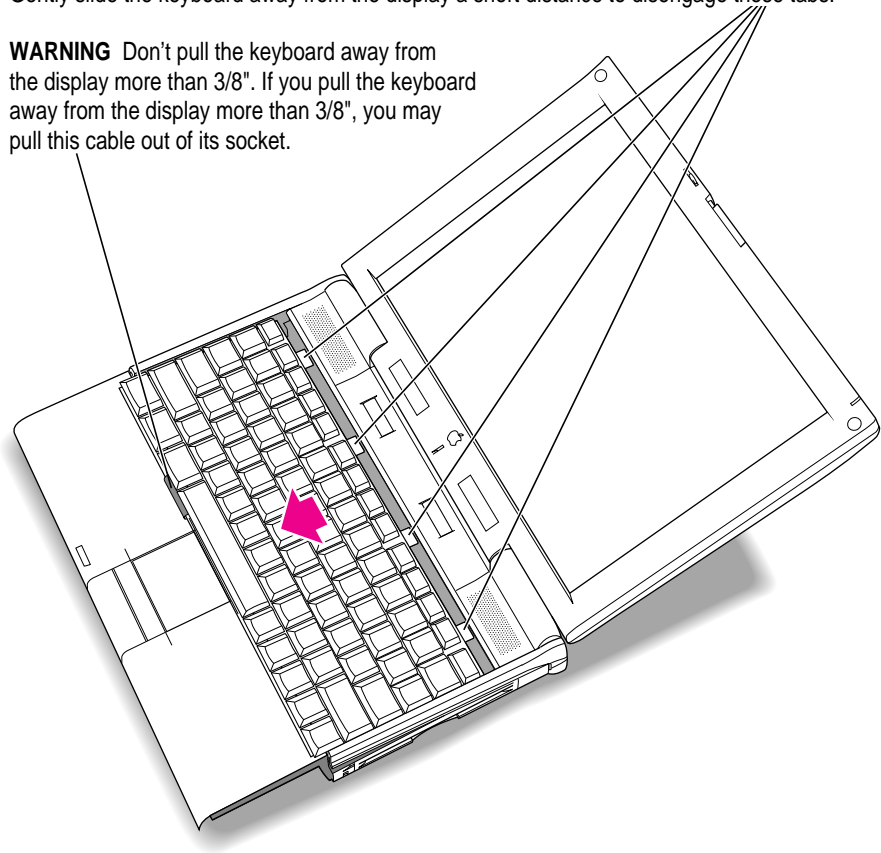

This action should release the top edge of the keyboard from its enclosure, allowing you to grasp and free the entire keyboard.

9 Place a clean, dry cloth over the display to protect it.

Place a soft, dry, clean cloth over the display to protect it from scratches.

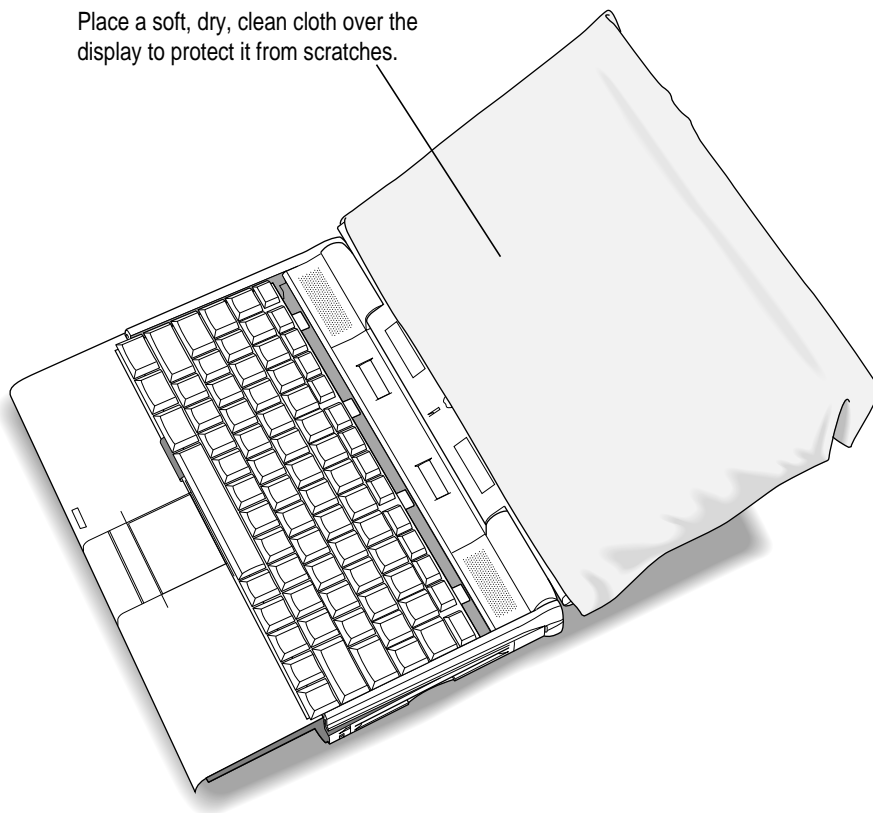

- 10 Lift the keyboard out of its enclosure and place it on the clean, dry cloth covering the display.**

Again, be very careful not to lift the keyboard too far out of its enclosure so that you don't pull the keyboard cable out of its socket.

Don't turn the keyboard over; just slide it up on the cloth.

Gently move the keyboard up and place it on the cloth

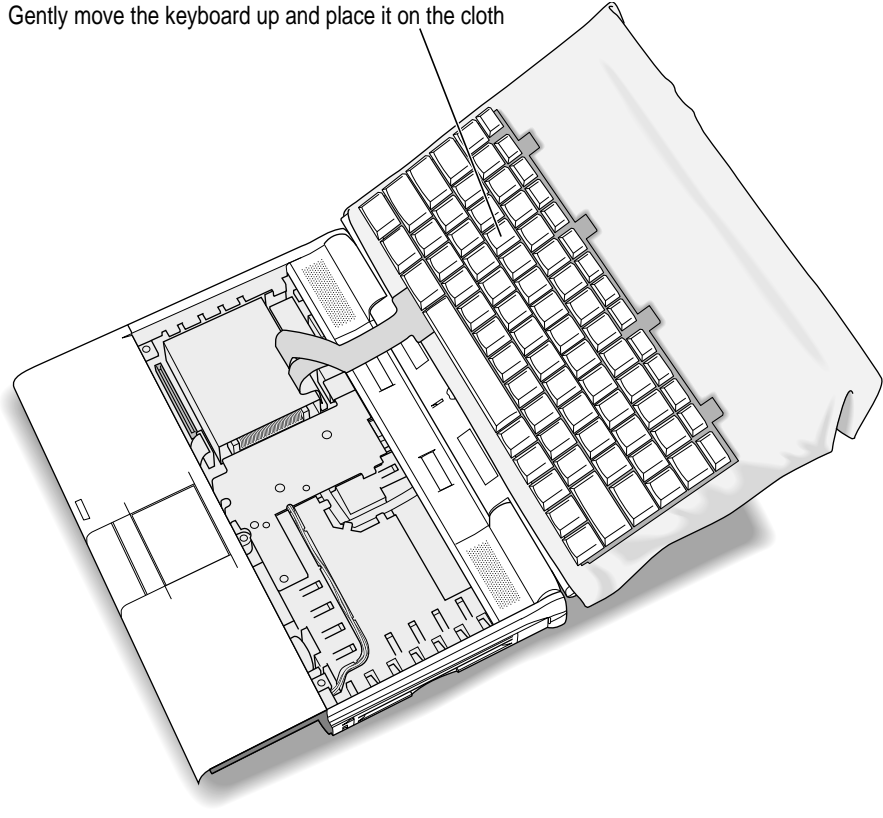

- 11 Gently touch the metal surface on the right side of the inside of the computer to discharge any static electricity built up on your body.**

This prevents you from damaging your Macintosh PowerBook or RAM card.

Avoid touching the heat sink inside the computer (shown in color here). If the computer has been on for a while, or the power adapter has been plugged in and charging the battery, the heat sink may have become hot. You may wish to allow it to cool for a few minutes before proceeding with the RAM card installation procedure.

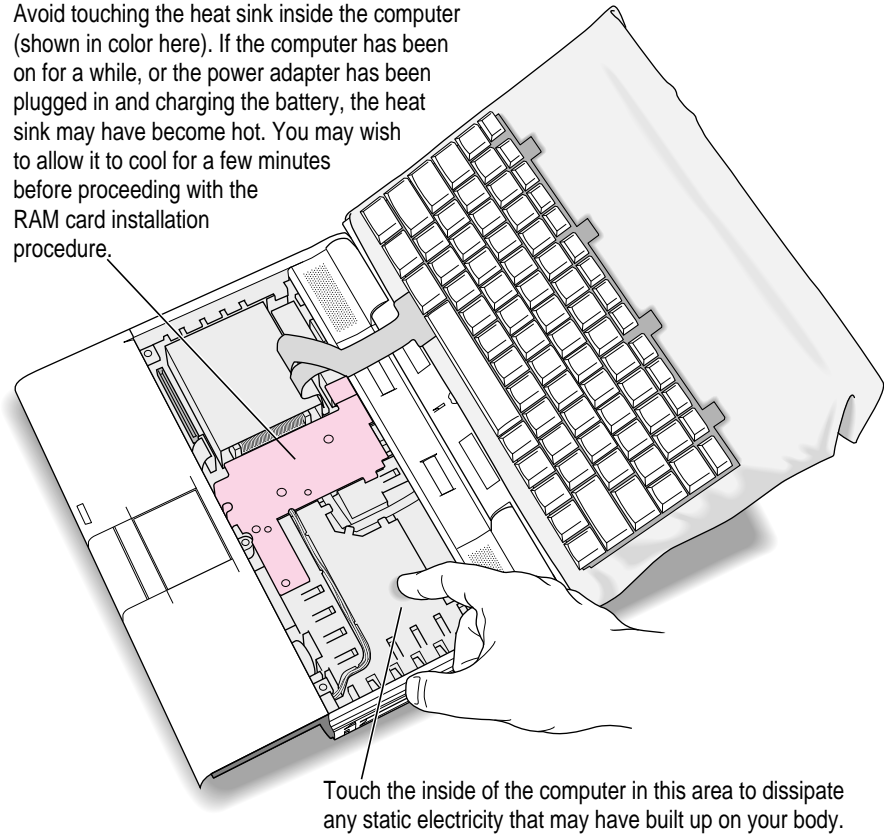

Touch the inside of the computer in this area to dissipate any static electricity that may have built up on your body.

Don't walk around while installing the card. If you do, make sure you do this step again to discharge any static electricity.

- 12** If you are replacing a RAM card, lift the corner of the RAM card you are replacing to remove it.

If you're replacing a RAM card, you'll need to remove the old one. Lift up on the RAM card in this corner to remove it.

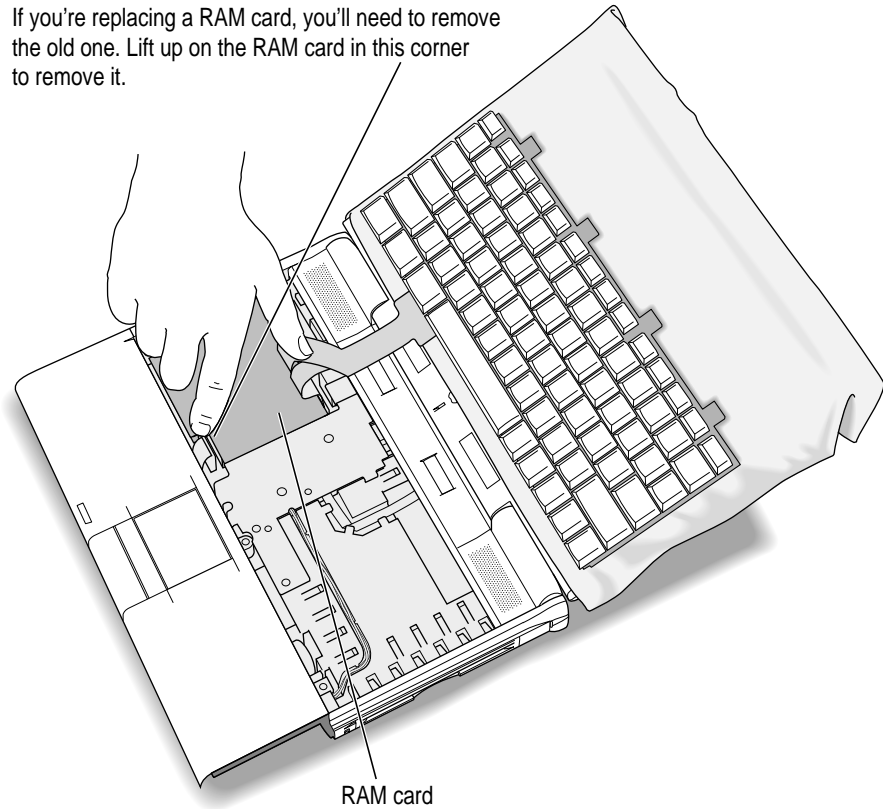

Be careful not to touch other parts of the computer's interior when lifting the card. Some parts may be hot if the battery has been charging or the computer has recently been used.

13 Remove the new RAM card from its protective package.

Hold the card by its edges. Don't touch the chips or metal parts of the card.

IMPORTANT Use a RAM card with TSOP low-profile RAM chips only. Installing a card with high-profile chips may damage your computer.

Save the protective package that the RAM card came in, in case you want to remove the card later.

14 Lower the card into the computer and align its connector with the socket on the main circuit board.

Make sure the ribbon cables for the keyboard go on top of the installed card.

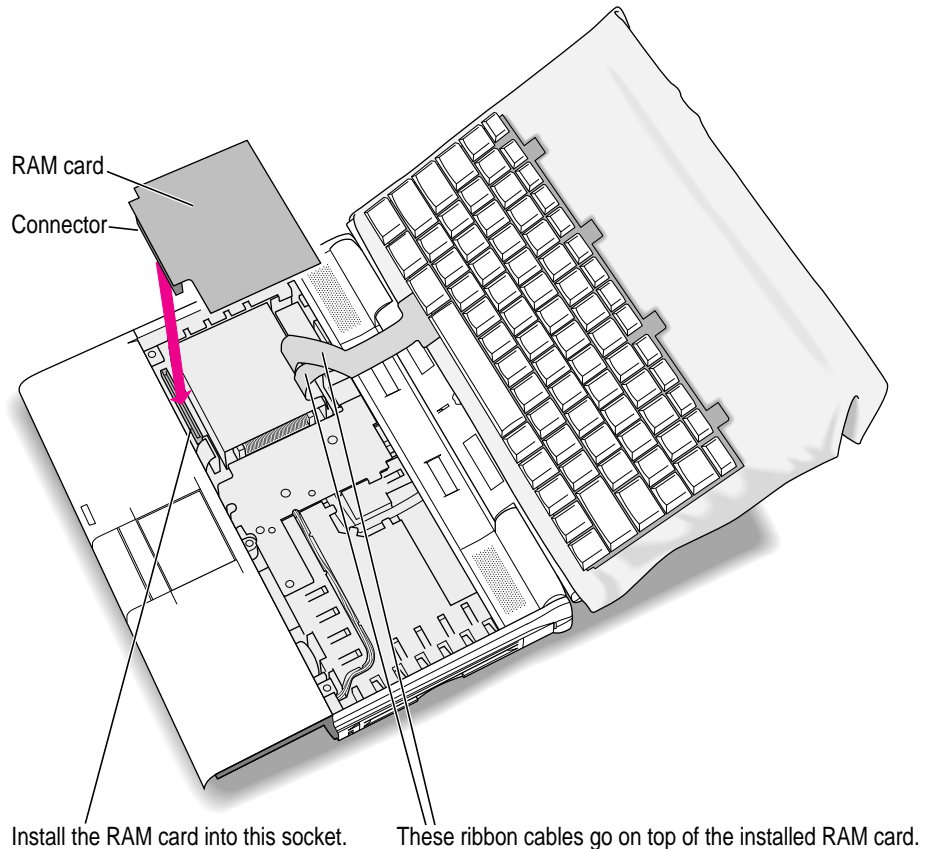

15 Lay the card flat, then gently press the card into the socket.

You need to exert some pressure to insert the card's connector into the socket. It's all right to wiggle the card to move it or to insert one side and then the other, but be very careful not to bend or bow the card.

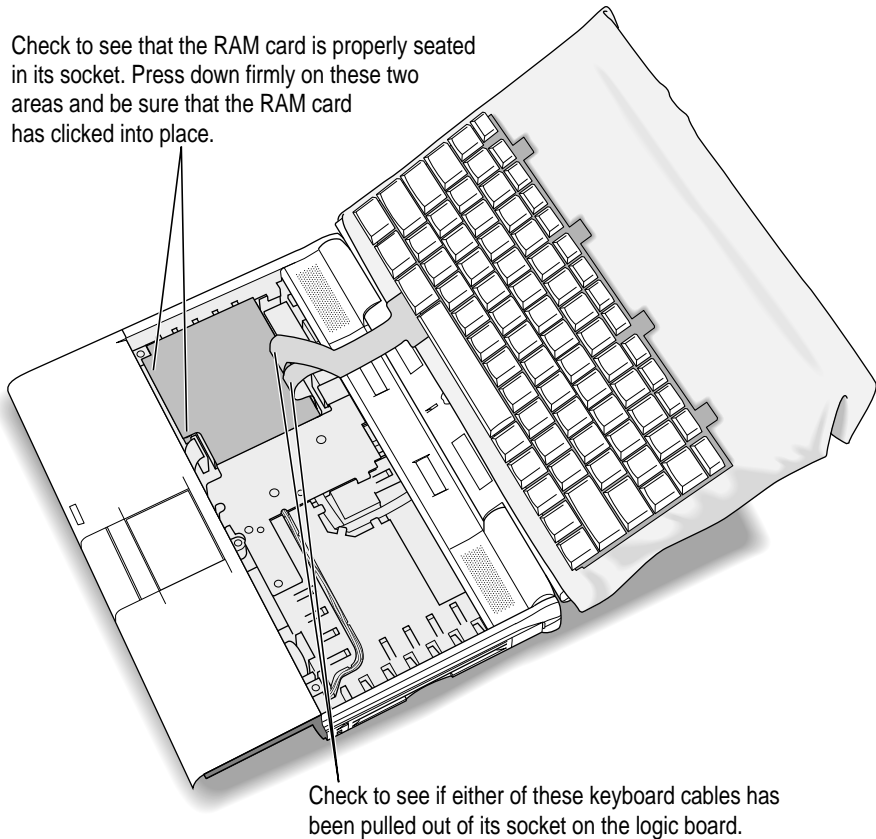

Check to see that the RAM card is properly seated in its socket. Press down firmly on these two areas and be sure that the RAM card has clicked into place.

Check to see if either of these keyboard cables has been pulled out of its socket on the logic board.

Make sure the keyboard cables are still properly connected.

If the keyboard cables are loose, follow these steps to replace the cables:

- 1 Lift the bail on the connector with a straightened paper clip or similar object.
- 2 Insert the ribbon cable into the connector.
- 3 Push down on the bail with a straightened paper clip or similar object to secure the ribbon cable.

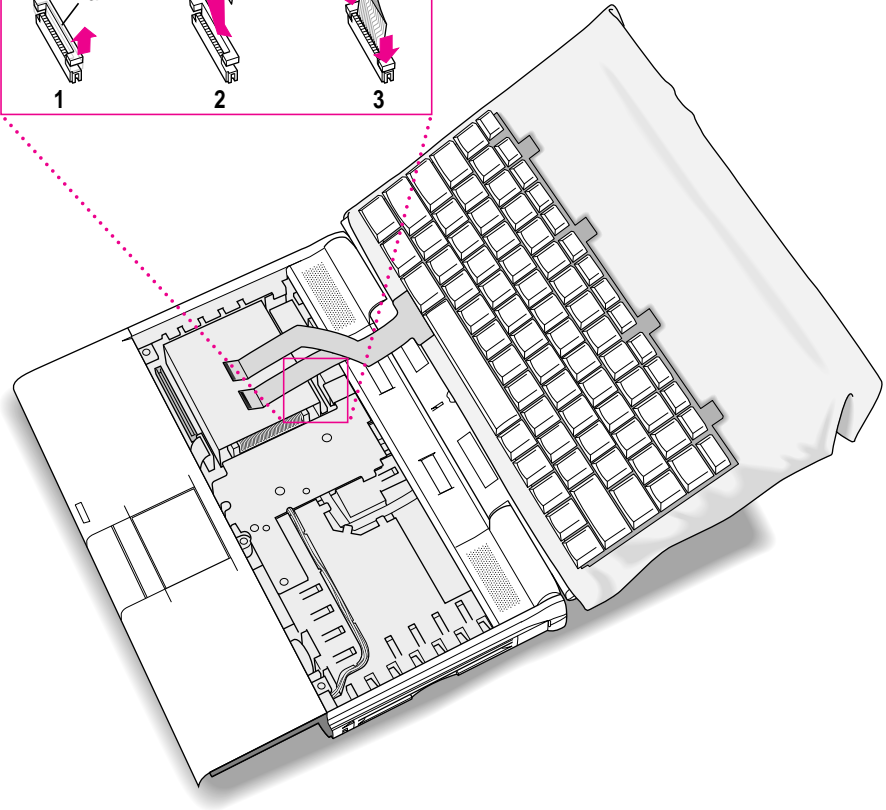
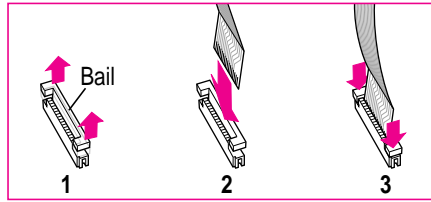

Be careful not to remove the foam on the keyboard cable. It protects the cable and keeps it from touching the RAM card.

- 16 Move the keyboard back toward its original position, and then slide the tabs at the top into the computer's enclosure.**

Hold the keyboard no more than an inch above the enclosure to avoid straining the cables.

Gently slide the keyboard back into the computer. These tabs go inside the computer.

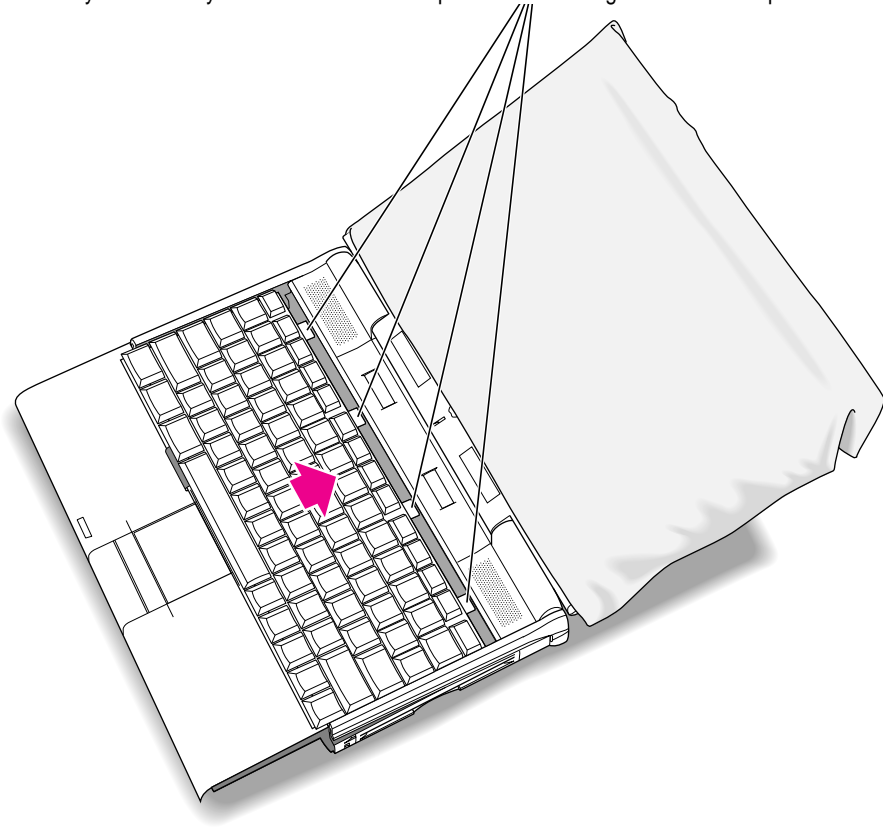

- 17 Lower the keyboard into place.**

If part of the keyboard doesn't lie flat within the enclosure, gently press that area down with your hand.

- 18 Remove the cloth from the display.**

- 19 Slightly close the display so it is at a 90-degree angle to the computer.

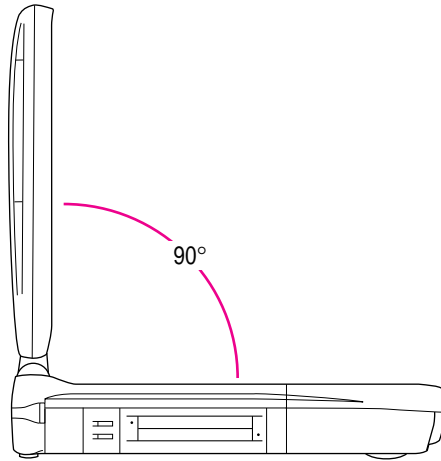

- 20 While holding the keyboard in place, rotate the Macintosh PowerBook so that the bottom of the computer is exposed, with the display flat against the table surface.

While holding the keyboard in place so that it doesn't fall out, rotate the computer so that the display is flat against the table surface.

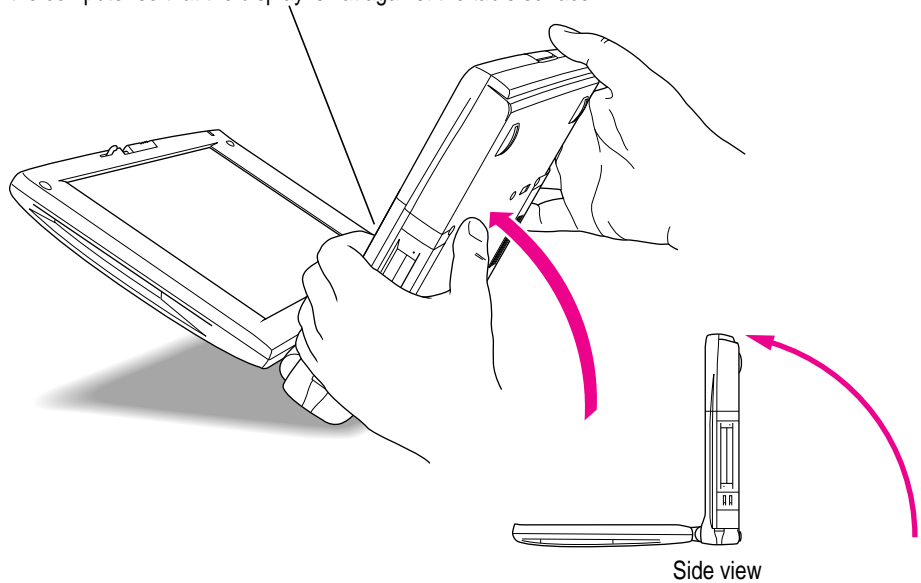

- 21** While continuing to hold the keyboard in place, replace the three screws on the bottom of the Macintosh PowerBook.

1 Gently but firmly squeeze the keyboard and the other parts of the computer together.

2 While squeezing the parts together, reinstall the three screws into the bottom of the computer.

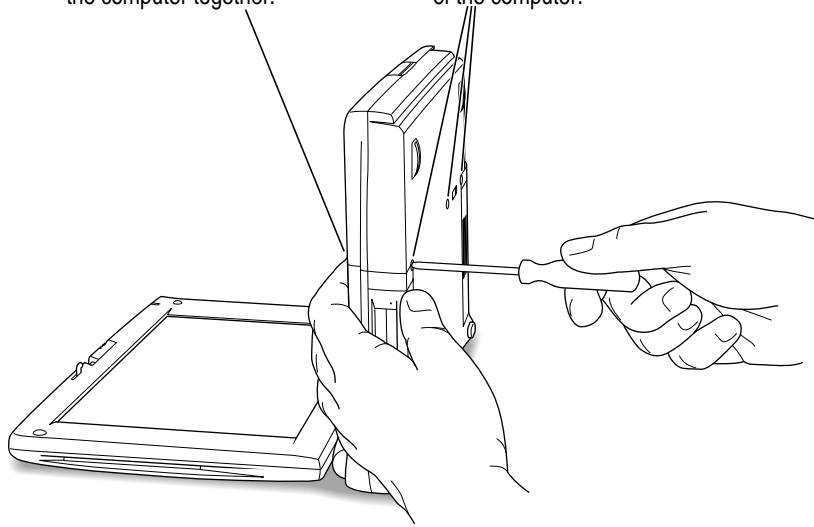

Not too tight: Take care not to overtighten the screws. Tighten them only until they are snug (when you feel resistance to your turning motion). It's better to leave them a bit loose than to make the screws too tight.

- 22** Turn over the computer and prepare to use it.

Replace the battery and reconnect the power adapter and any cables you removed before installing the RAM expansion card.

Making sure the card is properly installed

Once you have completed the process for installing a RAM expansion card, you can check to make sure the additional RAM is now available on your computer. Follow these steps:

- 1 Press the Power key to turn your computer on.**
- 2 Choose About This Computer from the Apple (🍏) menu.**
- 3 Look at the number of the total memory in your computer.**

Your total memory should be the built-in memory plus the amount of memory in the RAM expansion card that you just installed.

If the total memory number does not include the amount of RAM you installed, review the steps in this appendix to make sure you installed the card correctly. If you need more help, see an Apple-authorized dealer.

If you hear a different sound (breaking glass) or see a message that a memory error was detected when the computer started up, there may be a problem with the RAM expansion card. You should remove the card.

If you installed the RAM expansion card in your computer yourself, review the steps in this appendix to make sure you installed the card correctly. If you purchased an expansion card from a third-party manufacturer, contact the manufacturer for help.

You should run a full memory diagnostic program (not supplied with the computer) to verify the operation of the RAM card. An Apple-authorized technician can advise you about this procedure.

Refer to this appendix for information on connecting Ethernet and telephone cables to an expansion card in your computer.

Appendix D Making Modem and Ethernet Connections to an Internal Expansion Card



Your Macintosh PowerBook computer came with a card installed in the PCI expansion slot. The card provides an Ethernet connection or modem and Ethernet connections.

You can easily determine which type of card your computer has. Open the cover on the computer's back panel. On the computer you'll see a modular telephone-style connection (a socket) and on the cover is a label that shows the Ethernet icon (<=>) or a combined Ethernet and modem icon (<=>/☎).

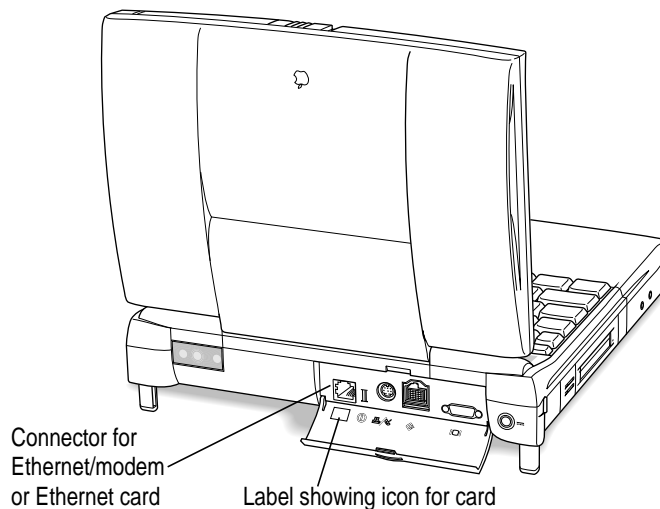

The cable or cables you need to use with the card are also supplied with the computer.



Connecting an Ethernet cable to the expansion card

Follow these steps to connect an Ethernet cable to the card in your PowerBook:

- 1 Open the cover on the computer's back panel and verify that your computer has a card with a modular connector.**

You can connect a modular (twisted-pair or 10Base-T) Ethernet cable to an Ethernet-only card or to the combination Ethernet/modem card. (A shielded Ethernet cable is supplied with your computer.)

- 2 Locate a modular Ethernet cable and connect one end of the cable to the network.**

Consult a network administrator or other expert if you need help making the network connection.

- 3 Connect the free end of the Ethernet cable to the modular connector on the card.**

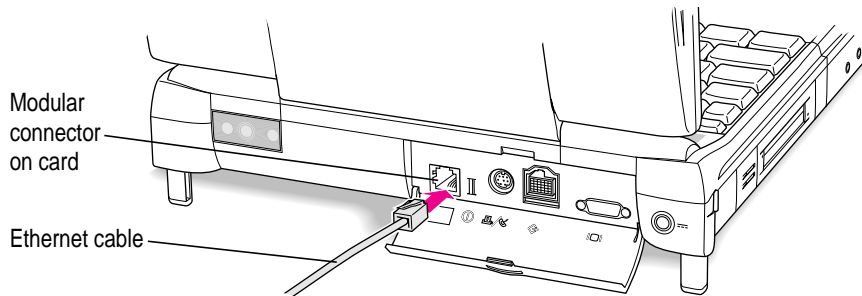

- 4 Start up the PowerBook, if it is not already on.**
- 5 To use your Ethernet connection, open the AppleTalk control panel and choose Ethernet from the "Connect via" pop-up menu.**

If you want to use a TCP/IP-based application, you may want to make sure that the TCP/IP control panel is configured appropriately.

For more detailed instructions on using the network control panels, see the Networks topic area of Mac OS Help, available in the Help menu.

Connecting a telephone line to the expansion card

If your card provides both modem and Ethernet connections, follow these steps to connect a standard telephone line to the card in your PowerBook:

- 1 With the PowerBook shut down, open the cover on the computer's back panel and verify that your computer has a card with a modular connector.

You can check the label on the inside of the cover to determine that the card provides a modem.

- 2 Connect one end of a modular telephone cord that came with your computer to the wall socket for a residential phone line.

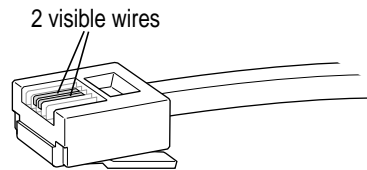

Single-line telephone cord

WARNING Make certain that the phone line is the standard (analog) residential line, not a digital line. Connecting a digital line to your modem card could damage it. Also, you must use a single-line telephone cord (supplied with your computer) to connect to the telephone line. A single-line phone cord has only two wires visible in the plastic connector (as opposed to the commonly used four-wire cord).

- 3 Connect the other end of the telephone cord to the modular connector on the card.

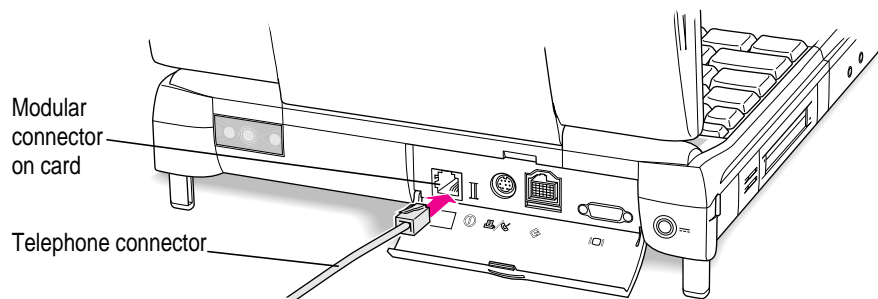

- 4 Start up the PowerBook, if it is not already on.
- 5 To use your modem, open the communications program you want to use and set up the program for the internal modem.

You also have fax software on your computer's hard disk. See the electronic manual located with the fax software for instructions.

In addition, your PowerBook has a collection of programs that give you access to the Internet. These programs are on the computer's hard disk. You can find out more about these programs in the Mac OS Info Center on the hard disk.

For more information about using a modem, see the "Connecting to the Internet" and Telecommunications topic areas of Mac OS Help, available in the Help menu.

IMPORTANT When you connect to the Internet or other service with your modem, you may see a message that reports a connection speed. The connection speed may vary, depending on the telephone line, the quality of the connection, and other factors that affect communications.

Using Ethernet and a modem at the same time

By using the adapter supplied with your computer if you have a combination Ethernet/modem card, you can connect both an Ethernet cable and a telephone line to the card. (In addition, you do not have to use the single-line (two-wire) phone cord when you use the adapter.)

To use both Ethernet and the modem, follow these steps:

- 1 Open the cover on the computer's back panel and verify that your computer has a card with a modular connector.

You can check the label on the inside of the cover to determine if you have the combination card.



Ethernet/modem card label

- 2 Locate the adapter that came with your computer and connect the single end of it to the card in your computer.

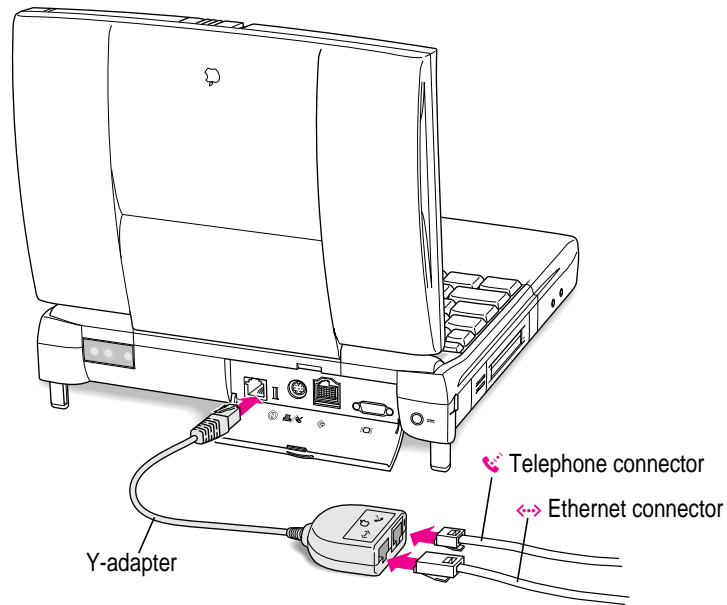

- 3 Prepare the Ethernet cable and telephone line as you would for a single connection of either type.
- 4 Plug the modular connector from the Ethernet cable and the telephone cord into the two sockets in the Y-adaptor.
- 5 Start up the computer (if it is not already on) and set up your software to use the modem and Ethernet connections.

If you can't find what you're looking for in this index, look in Mac OS Help—available in the Help menu on your computer.



Index

• • • • •

A

- About This Computer
 - (Apple menu) 66, 139
- AC adapter. *See* power adapter
- accent marks, typing 117–118
- access privileges to shared disks or files 79, 80, 81
- acute accent (´), typing 118
- adapters. *See also* power adapter
 - Ethernet/modem card 144–145
 - monitor 42, 43, 44
 - plug 112–113
 - video 73
- ADB devices, connecting 47
- ADB port 2, 31, 47
- airline regulations for portable computers 112
- analog phone lines 30, 83, 143
- Apple Assistance Center 57, 59, 73
- Apple-authorized service
 - providers/dealers
 - battery repair or replacement 52
 - disposing of spent batteries 55, 111
 - flickering screen 73
 - installing a RAM expansion card 121, 139
 - liquid spills onto the computer 110
 - memory upgrades 48
 - obtaining Apple peripheral devices, cables, and connectors 23, 42
 - RAM or cache memory errors 70
 - recovering the hard disk 88
 - repair service 57, 59, 87, 109, 113
- Apple Desktop Bus. *See* ADB
- Apple menu
 - About This Computer 66, 139
 - Chooser 32, 33, 74–75, 79–81
 - Key Caps 72, 117–118
- Apple multiscan external monitors supported 41
- Apple Remote Access 82–83
- AppleTalk
 - connecting an Ethernet cable and 142
 - connecting an external modem and 33
 - connecting a printer and 32, 75
 - conserving battery power and 56
 - using a network or file sharing and 79–81
- AppleTalk control panel 79
- Application menu, Show All 67
- arm discomfort or pain from using computers 107
- arrow keys 116
- ATA hard disk, preventing ejection at startup 28–29
- automatic sleep 12, 51. *See also* sleep

B

- backlighting, conserving battery
 - power and 56
- backup cell 50
- battery
 - conserving power 10, 12, 50–51, 56
 - disposal of 55, 111
 - expected work time from 49, 56
 - handling 110–111
 - illustration 2, 5
 - inserting 55
 - locking 23
 - monitoring the charge level 50–52
 - recharging 5–6, 49, 51, 53, 63
 - removing/replacing 54–55
 - safety instructions for 5, 51, 109, 110–111, 112
 - SCSI disk mode and 35, 38
 - transporting 109
 - troubleshooting 58
 - unwrapping 4–5
- battery cap 54, 55, 109, 110
- battery icons, interpreting 51
- battery level indicator button 52
- battery level indicator lights 50, 52
- battery release button 5, 54
- brightness control
 - adjusting 8, 58, 60, 73
 - illustration 2, 8

C

- cables
 - for Ethernet connections 141, 142, 144
 - for external monitors 42, 43, 44
 - HDI-30 SCSI Disk Adapter Cable 34–35, 36–37, 38, 77–78
 - HDI-30 SCSI System Cable 34–35, 37, 77–78
 - keyboard 128, 130, 133–135
 - safety instructions for 36, 109
 - SCSI Peripheral Interface Cable 34–35

- Caps Lock key 116
- carpal tunnel syndrome 104
- CD-ROM drive
 - opening 19, 21, 90
 - switching with another module 15–18
 - using CDs in 19–21
 - vibrations and noise in 20
- CDs
 - care of 20
 - conserving battery power and 56
 - ejecting 21–22
 - inserting 19–20, 90
 - starting up the computer with 59, 87, 90, 97
- cedilla (ç), typing 118
- chair, adjusting for optimal support and comfort 105
- charge level of battery, monitoring 50–52
- charging the battery 5–6, 49, 51, 53, 63
- Chooser (Apple menu)
 - connecting an external modem 33
 - connecting a printer 32, 74–75
 - network troubleshooting 79–81
- circumflex (^), typing 118
- cleaning the computer 110
- clean installation of system software 92, 99–101
- colors, decreasing number to display 73
- color support on external monitors 40–41
- Command (⌘)-Control-Power keys, to restart the computer 10, 13, 58, 59, 62, 63, 119
- Command (⌘)-E keys, to eject a CD 21
- Command (⌘) key 116
- Command (⌘)-Option-Esc keys, to force a program to quit 62, 63, 119
- Command (⌘)-Option keys, to rebuild the desktop 67, 68, 119
- Command (⌘)-Option-P-R keys, to reset PRAM 59, 86
- Command (⌘)-Power keys, to start a debugging application 119

- compact discs. *See* CDs
 - compatibility issues, programs and system software extensions 65, 85–86
 - connecting
 - ADB devices 47
 - to another computer 35–38
 - an Ethernet cable to an expansion card 141, 142
 - an external modem 33
 - an external monitor 39, 42–44
 - a mouse or keyboard 47
 - to a network 79–81
 - a printer 32
 - SCSI devices 34–38
 - sound input and output devices 45–47
 - a telephone line to an expansion card 30, 82–83, 143–145
 - connection speed of modem 144
 - connectors
 - Ethernet/modem or Ethernet card 2, 31, 141–145
 - RAM expansion card 122, 133–134
 - safety instructions for 109
 - telephone 143–145
 - conserving battery power 10, 12, 50–51, 56
 - Control key 116
 - control panels
 - AppleTalk 79
 - Easy Access 69
 - Extensions Manager 62, 86
 - File Sharing 80, 81
 - Infrared 48
 - Memory 61–62, 66, 69
 - Monitors & Sound 46, 47, 73
 - Password Security 23, 37, 76, 77, 90
 - PowerBook 67, 73, 74
 - PowerBook Setup 36
 - Remote Access Setup 82–83
 - resetting PRAM and 59
 - Sound 69
 - Startup Disk 28–29, 71, 97
 - TCP/IP 79, 142
 - Control Panels folder 86
 - Control Strip
 - adjusting display of colors 73
 - adjusting sound volume 47
 - changing external monitor resolution 43, 73
 - monitoring the battery charge 50, 53
 - cumulative trauma disorders (CTDs) 104
 - customer assistance 114.
 - See also* Apple-authorized service providers/dealers
 - custom installation of system software 93, 95–97
 - custom settings and special software, restoring 89
- D**
- data transfer, with infrared communications 48
 - Delete key 116
 - Desktop PrintMonitor 75
 - diacritical marks, typing 117–118
 - diagnostic techniques. *See also* error messages; troubleshooting
 - checking system software extensions 85–86
 - reinstalling system software 88–101
 - testing your hard disk 87–88
 - digital phone lines 30, 83, 143
 - dimming of the screen.
 - See* screen-dimming feature
 - discharging static electricity 131
 - disk cache 62, 66, 69, 86
 - Disk First Aid program 91
 - disk-security software 90
 - display
 - electromagnetic emissions from 108
 - minimizing glare and reflections 107, 108
 - opening 3–4
 - positioning 3, 107
 - troubleshooting 72–73
 - disposal of spent batteries 55, 111
 - docking mode 40
 - Drive Setup program 87–88, 92, 98
 - dual speakers 2

E

- Easy Access control panel 69
- Eject CD command (File menu) 21
- ejecting
 - CDs 21–22
 - floppy disks 70
 - PC Cards (PCMCIA cards) 26–28
 - shared disks 80
- Eject PC Card command,
 - Special menu 26
- electrical outlet types for most countries 113
- electromagnetic emissions from monitors 108
- elevation feet 2, 4, 107
- elevation foot release button 2, 4, 107
- Empty Trash command (Special menu) 98
- Enter key 116
- equipment, arranging to prevent discomfort 105–108
- error messages. *See also* diagnostic techniques; troubleshooting
 - about font files 68
 - about system errors 63
 - about system software 60, 61
 - “Apple Remote Access is not installed correctly” 83
 - “a problem was detected with RAM or cache memory” 70
 - “disk can’t be ejected because it’s being shared” 80
 - “file sharing can’t be turned on” 80
 - “item can’t be shared” 80
 - “not enough disk space” 98
 - “not enough memory” 61–62, 66
 - number codes in 61, 64
 - “program can’t be found” 67
 - “program has quit” 65
 - “sad Macintosh” icon 59
 - “System file cannot be modified” 99
 - when trying to print 75
- Escape key 116
- Ethernet cable, connecting to an expansion card 141, 142, 144
- Ethernet/modem or Ethernet card 141–145
- Ethernet/modem or Ethernet connector 2, 31, 141–145
- expansion bay drive in-use light 2
- expansion bay module
 - inserting 18
 - locking 23
 - purchased from an independent supplier 15
 - removing 15, 16–17
 - unlocking 16
 - using narrow modules 18
- expansion card
 - connecting an Ethernet cable to 141, 142
 - connecting a telephone line to 30, 82–83, 143–145
 - label for 2, 31, 141, 144
- extensions. *See* system software extensions
- Extensions folder 75, 82, 86
- Extensions Manager control panel 62, 86
- external disk drive, using the PowerBook as 35–38, 76–78
- external modems 33, 78
- external monitor
 - changing resolution of 43, 73
 - connecting 42–44
 - disconnecting 44
 - electromagnetic emissions from 108
 - minimizing glare and reflections 108
 - positioning 42, 108
 - PowerBook support for 39–41
 - selection considerations 39–40
 - troubleshooting 43–44, 72, 73–74, 78
 - video adapter 73
- external monitor port 2, 31, 39, 43, 44
- eye fatigue from computer use 103, 105, 108

F

fatigue from computer use 103, 105, 108

File menu

- Eject CD 21
- Get Info 64, 66, 68, 75, 99
- Open 67
- Put Away 15, 16, 17, 21, 26
- Sharing 69

files

- infrared transfer of 48
- locked 68, 99
- troubleshooting 68–69
- unlocking 68, 99

file sharing

- troubleshooting 79–81, 86
- turning off 69

File Sharing control panel 80, 81

File Sharing folder 80

Finder 10, 12

Find File command 63, 64

flashing question mark on screen

- 9, 61, 77

floppy disk drive

- illustration 2
- switching with another module 15–18
- troubleshooting 70–71

floppy disks

- ejecting 70
- handling 111
- troubleshooting 70–71
- unlocking 65, 69, 71

folders

- Control Panels 86
- Extensions 75, 82, 86
- File Sharing 80
- Fonts 68
- Modem Scripts 82
- Preferences 80
- Previous System Folder 99, 101
- shared 69
- System Folder 64, 86, 99–101
- Utilities 87, 98

font files, troubleshooting 68

Fonts folder 68

Force Quit 62, 63

Function keys 116

furniture, arranging to prevent discomfort 105–106

G

Get Info command (File menu) 64, 66, 68, 75, 99

graphics tablet, connecting 47

grave accent (`), typing 118

gripping surface on the expansion bay module 17, 18

grounding the computer 6

H

hand discomfort or pain from using computers 107

hard disk

- avoiding damage to 11
- making space available 98
- protecting with a password 23
- reinitializing 88, 98
- repairing 98
- testing 87–88
- troubleshooting 71, 87, 98
- using the PowerBook as 35–38, 76–78

HDI-30 SCSI Disk Adapter Cable 34–35, 36–37, 38, 77–78

HDI-30 SCSI System Cable 34–35, 37, 77–78

health-related information about computer use 103–108

heat sink inside the computer 131

Help menu 13, 14, 57

I, J

- icons
 - battery 51
 - blinking in the menu bar 69
 - dragging to the Trash 15, 16, 17, 21, 26
 - look different from usual 68
 - “sad Macintosh” 59
 - SCSI 37, 76
- ID numbers for SCSI devices 34, 36, 37, 78
- Infrared control panel 48
- Infrared Data Association Standard specifications 48
- infrared file transfer 48
- infrared window 2, 31
- initializing the hard disk 88, 98
- inserting
 - a battery 55
 - CDs 19–20, 90
 - an expansion bay module 18
 - PC Cards (PCMCIA Cards) 25–26
- installing
 - RAM expansion card 121–139
 - system software 88–101
- interference
 - on an external monitor 74
- international symbols and characters, typing 117–118
- Internet 144
- IR. *See* infrared
- IRTalk transfer protocol 48

K

- keyboard
 - adjusting 107
 - cables 128, 130, 134–135
 - connecting 47
 - positioning your hands on 106–107
 - raising and loosening 127–128
 - replacing 135–136
 - special keys on 116
 - troubleshooting 72, 78
- Key Caps (Apple menu) 72, 117–118

L

- label for expansion card 2, 31, 141, 144
- liquid spills on the computer 110
- lithium ion (LiIon) battery.
 - See also* battery
 - disposal of 55, 111
 - overview 49
 - using battery level indicator lights 50, 52
- location for computer, choosing 1, 105
- locked disks 65, 69, 71
- locked files 68, 99
- locking the expansion bay module and battery 23
- low-power messages 38, 50–51
- low-profile memory chips 122, 133

M

- Macintosh Easy Open, rebuilding the desktop and 67, 68
- Mac OS 8, installing 89–101
- Mac OS Help 13, 57
- Mac OS Info Center 14, 144
- Mac OS Install program 91–101
- Mac OS Setup Assistant 13, 14
- memory. *See also* RAM
 - adding 48, 121–139
 - checking amount of 139
 - freeing/reassigning 66
 - troubleshooting 60, 61–62, 65, 66, 69
 - virtual 48, 61, 66, 86
- Memory control panel 61–62, 66, 69
- memory diagnostic program 139
- microphone
 - built-in 2, 45, 46
 - PlainTalk 45
- mirroring 39
- modem/printer port. *See* printer/external modem port
- modems
 - external 33
 - PC Card 29–30, 143–145
 - troubleshooting 82–83
- Modem Scripts folder 82

- module release latch 16, 17, 18
- monitor. *See* external monitor
- monitor adapter 42, 43, 44
- monitor cable 42, 43, 44
- Monitors & Sound control panel
 - 46, 47, 73
- monochrome external monitors supported
 - 40, 41
- mouse
 - connecting 47
 - positioning 107
 - troubleshooting 78
- moving the computer 109, 112–113
- musculoskeletal discomfort from
 - computer use 103, 104, 108

N

- network problems, troubleshooting
 - 79–81
- nickel-metal-hydride (NiMH) battery.
 - See also* battery
 - disposal of 55, 111
 - overview 49
- NTSC Display external monitors
 - supported 41

O

- office furniture, arranging to prevent
 - discomfort 105–106
- online information/help 13–14, 57
- Open command (File menu) 67
- opening
 - the CD-ROM drive 19, 21, 90
 - the display 3–4
 - shared disks or files 79–81
- Option key 116, 117–118, 119

P

- PAL Display external monitors
 - supported 41
- paper wrapper covering the battery 4–5
- parameter RAM. *See* PRAM
- part numbers
 - for monitor adapter 42
 - for power adapter 5, 49
 - for SCSI cables 34
- password protection
 - SCSI disk mode and 37, 76, 77
 - turning off 37, 76, 77, 90
 - turning on 23
- Password Security control panel 23, 90
 - SCSI disk mode and 37, 76, 77
- PC Card eject buttons 2
- PC Card modems 29–30, 143–145
- PC Cards (PCMCIA cards)
 - compatibility issues 24
 - conserving battery power and 56
 - ejecting 26–28
 - inserting 25–26
 - preventing ejection at startup 28–29
 - slots for 2, 24, 25
 - storage case 15, 18
 - troubleshooting 27–28
 - types of 24
- Personal Web Sharing 93
- plug adapters for overseas travel
 - 112–113
- ports
 - ADB 2, 31, 47
 - external monitor 2, 31, 39, 43, 44
 - power adapter 2, 6, 31, 53
 - printer/external modem 2, 31, 32
 - safety instructions for 109, 110
 - SCSI (HDI-30) 2, 31, 36, 37
 - sound input 2, 31, 45, 46
 - sound output 2, 31, 46
- positioning
 - the display 3, 107
 - an external monitor 42, 108
 - the keyboard and trackpad 106–107
 - a mouse 107

- power, conserving 10, 12, 50–51, 56
- power adapter
 - charging the backup cell 50
 - overseas travel and 112
 - part number 5, 49
 - plugging in 5–6
 - recharging the battery with 49, 53, 63
 - SCSI disk mode and 38
 - troubleshooting 8, 58
- power adapter port 2, 6, 31, 53
- PowerBook CD, starting up the computer with 59, 87, 90, 97
- PowerBook control panel 67, 73, 74
- PowerBook Setup control panel,
 - assigning a SCSI ID number 36
- power conservation settings,
 - changing 71
- power cord 6
 - for an external monitor 42
- Power key
 - illustration 2, 7, 116
 - putting the computer to sleep 11
 - restarting the computer 12, 13, 119
 - turning on the computer 7, 8, 116
 - turning off the computer 9, 10, 113, 116
 - waking the computer 9, 10
- power sources 49
- PRAM, resetting 59–60, 86
- Preferences folder 80
- Previous System Folder 99, 101
- printer
 - connecting 32
 - troubleshooting 74–75, 78
- printer/external modem port 2, 31, 32
- programs
 - compatibility issues 65
 - quitting before removing expansion bay modules 15, 16, 17
 - troubleshooting 63–67
- Put Away command (File menu) 15, 16, 17, 21, 26
- putting the computer to sleep 10–12, 17, 56

Q

- question mark flashes on screen 9, 61, 77
- QuickDraw 3D 93
- quitting programs, removing expansion bay modules and 15, 16, 17
- quitting SCSI disk mode 38

R

- RAM. *See also* memory; PRAM
 - retaining contents of following low-battery messages 51
 - testing 59
- RAM disk
 - memory problems and 62, 66, 69
 - resetting PRAM and 59
 - restarting the computer and 12
- RAM expansion card
 - connectors 122, 133–134
 - installing 121–139
 - troubleshooting 60
 - verifying operation of 139
- Read Me file 89
- rebuilding the desktop 62, 67, 68
- recharging
 - the backup cell 50
 - the battery 5–6, 49, 51, 53, 63
- recording sound 45–46
- refresh rate on external monitors 40–41
- reinitializing the hard disk 88, 98
- reinstalling system software 88–101
- release button
 - on battery 5
 - for elevation feet 2
- release latch for expansion bay module 16, 17, 18
- Remote Access Setup control panel 82–83

- removing
 - the battery 54–55
 - CDs 21–22
 - an expansion bay module 15, 16–17
 - paper wrapper on the battery 4–5
 - PC Cards (PCMCIA cards) 26–28
 - a RAM expansion card 123–132
 - system software components 93, 95–97
 - repetitive stress injuries (RSIs) 104
 - replacing
 - the battery 54–55
 - a RAM expansion card 123–139
 - reset button
 - illustration 2, 31
 - when the battery is drained 8
 - when the computer won't restart 13, 58–59, 62, 63
 - when the computer won't shut down 10, 37
 - resetting PRAM 59–60, 86
 - resolution on external monitors 39–41, 74
 - Restart command (Special menu) 12, 13, 90
 - restarting the computer 12–13, 58–59, 62, 63, 119. *See also* starting up the computer; turning on the computer
 - restoring custom settings and special software 89
 - Return key 116
 - RGB external monitors supported 40, 41
 - ribbon cables for keyboard 128, 130, 133–135
- S**
- “sad Macintosh” icon, troubleshooting 59
 - safety instructions
 - batteries 5, 51, 109, 110–111, 112
 - cables 36, 109
 - cleaning the computer 110
 - connecting SCSI devices 34
 - connecting a telephone line to a modem card 30, 83, 143
 - connectors 109
 - ejecting PC Cards (PCMCIA cards) 26
 - floppy disks 111
 - grounding the computer 6
 - keyboard and trackpad 110
 - liquid spills onto the computer 110
 - moving the computer 11, 109, 112
 - ports 109, 110
 - power adapter 53
 - removing expansion bay modules 15, 16, 17
 - temperature ranges for the computer 110, 113
 - saving settings 7
 - saving your work
 - determining battery charge level and 52
 - low-power messages and 50
 - removing/replacing the battery and 54, 55
 - restarting the computer and 62, 63
 - screen. *See* display; external monitor
 - screen-dimming feature
 - adjusting onset of 67, 74
 - external monitors and 44, 73–74
 - low-power messages and 51
 - restoring brightness 67, 72
 - turning off 73, 74
 - screwdriver, type needed to install a
 - RAM expansion card 122, 124
 - SCSI cables 34–35, 36–37, 38, 77–78
 - SCSI chains 34, 36–37, 38
 - SCSI devices
 - connecting 34–38
 - troubleshooting 76, 78
 - SCSI disk mode 35–38, 76–78
 - SCSI (HDI-30) port 2, 31, 36, 37
 - SCSI icon 37, 76
 - SCSI ID numbers, setting 34, 36, 37, 78
 - SCSI Peripheral Interface Cable 34–35

- SCSI terminators 34, 35, 77, 78
- security cable and lock 23
- security slot 2, 23
- service and support 114. *See also*
 - Apple-authorized service providers/dealers
- settings, saving 7
- setting up the computer 1–6
- Setup Assistant. *See* Mac OS
 - Setup Assistant
- shared disks 79–81, 83
- shared folders 69
- Sharing command (File menu) 69
- Shift key 116
 - Key Caps program and 117
- Show All command
 - (Application menu) 67
- Shut Down command (Special menu)
 - 10, 13, 113
- shutting down the computer 9–10, 113
- side panels of computer, lifting 127
- SimpleSound program 46
- simulscan 39, 44
- single-line telephone cord 143, 145
- sleep. *See also* waking the computer
 - automatic 12, 51
 - following low-power messages 51
 - preventing 90
 - putting the computer to sleep 10–12, 17, 56
- Sleep button 11
- Sleep command (Special menu) 11
- sleep indicator 2, 11, 59
- Small Computer System Interface. *See* SCSI
- sound
 - adjusting volume 47
 - recording 45–46
 - unusual sound coming from the computer 69
- Sound control panel 69
- sound input/output devices, connecting 45–47
- sound input port 2, 31, 45, 46
- sound output port 2, 31, 46
- speakers 2
- Special menu
 - Eject PC Card 26
 - Empty Trash 98
 - Restart 12, 13, 90
 - Shut Down 10, 13, 113
 - Sleep 11
- speed variations of CDs 20
- SRAM card, preventing ejection at
 - startup 28–29
- standard installation of system software
 - 93, 94
- starting up the computer. *See also* restarting the computer; turning on the computer
 - with extensions off 60, 61, 85–86
 - switching expansion bay modules and 15
 - with the system software CD 59, 87, 90, 97
 - troubleshooting 58–62, 71
- Startup Disk control panel
 - preventing ejection of storage PC Cards at startup 28–29
 - selecting a startup disk 71, 97
- static electricity, discharging 131
- stereo miniplug 46
- stereo speakers 2, 46
- storage PC Cards, preventing ejection at
 - startup 28–29
- storing the computer 113
- SVGA external monitors, connecting
 - 39, 42, 43
- symbols and international characters, typing 117–118
- system failures 64
- System Folder
 - creating new 99–101
 - discarding extra 64
 - locating problem extensions in 86
- system software
 - installing 89–101
 - troubleshooting 9, 60, 61, 87, 97–99
- system software CD, starting up with
 - 59, 87, 90, 97
- system software extensions
 - turning off 60, 61, 62, 85–86
 - turning on 86

T

- Tab key 116
- TCP/IP control panel 79, 142
- telephone cord, type to use 143, 145
- telephone line, connecting to a modem
 - card 30, 82–83, 143–145
- temperature ranges
 - for the computer 110, 113
 - for floppy disks 111
- terminators, SCSI 34, 35, 77, 78
- testing
 - the hard disk 87–88
 - RAM 59, 139
- three-wire grounding plug 6
- tilde (~), typing 118
- Torx T-8 screwdriver 122, 124
- trackpad
 - correct position for your hands 106–107
 - illustration 2, 106
 - troubleshooting 71–72
- trackpad button 2
- transferring information between computers 35–38
 - using infrared file transfer 48
- transporting the computer 109, 112–113
- Trash, dragging icons to 15, 16, 17, 21, 26
- tray of CD-ROM drive, opening/closing 20, 21–22
- troubleshooting. *See also* diagnostic techniques; error messages
 - battery problems 52, 58, 63
 - computer “freezes”
 - at restart 13, 62
 - at shutdown 10
 - at startup 61, 86
 - when screen dimming takes effect 73, 74
 - when you’re working in a program 63–64
 - display problems
 - flickering screen 73
 - screen dimming 67, 72, 73
 - screen went blank 67, 72
 - external monitor problems 43–44, 72, 73–74, 78
 - floppy disk problems 70–71
 - hard disk problems
 - in SCSI disk mode 37, 76–78
 - at startup 71
 - while installing software 98
 - hardware problems
 - ejecting CDs 22
 - ejecting PC Cards (PCMCIA cards) 27–28
 - keyboard 72, 78
 - modem 82–83
 - mouse 78
 - pointer sticks or jumps 72
 - power adapter 8, 58
 - printer 74–75, 78
 - SCSI equipment 76, 78
 - trackpad 71–72
 - typing produces nothing on screen 72
 - memory problems
 - can’t access memory 69
 - not enough memory 61–62, 65, 66
 - PRAM 59–60
 - RAM or cache memory errors detected 70
 - RAM expansion card 60
 - modem problems, Apple Remote Access 82–83
 - network/file sharing problems 79–81, 83, 86
 - shutting down the computer 10
 - sleep indicator light glows steady green 59

- startup problems
 - computer doesn't start up 58
 - computer makes unusual sounds 59–60, 69
 - computer shuts down right after startup 63
 - desktop doesn't appear at startup 60
 - desktop rebuilds at startup 63
 - flashing question mark on screen 9, 61, 77
 - nothing happens when you press the Power key 8
 - restarting the computer 13, 58–62
 - “sad Macintosh” icon 59
 - starting up the computer 58–62, 71
 - turning on the computer 8–9
 - system software problems
 - computer can't find the software 9, 61
 - during installation 97–99
 - with extensions 86
 - wrong or damaged version of 60
 - waking the computer 63
 - working with programs/files
 - can't open documents 67
 - damaged font files 68
 - file can't be thrown away 68–69
 - icons are blinking in the menu bar 69
 - icons look different from usual 68
 - program quits or disappears 65–66
 - program won't open 65
 - system errors 63
 - system failures 64
 - a window has disappeared 67
 - turning on the computer 7–9. *See also* restarting the computer; starting up the computer
 - turning off the computer 9–10. *See also* Shut Down command; shutting down the computer
 - Type I, II, or III PC Cards 24, 25
 - typing, international characters and symbols 117–118
- U**
- umlaut (¨), typing 118
 - unlocking
 - the expansion bay module 16
 - a file 68, 99
 - a floppy disk 65, 69, 71
 - unwrapping the battery 4–5
 - Utilities folder 87, 98
- V**
- VGA external monitors
 - connecting 39, 42, 43
 - types supported 40
 - vibration in CD-ROM drive 20
 - virtual memory 48, 61, 66, 86
 - virus-detection programs 64, 90, 99
 - voltage transformer 112
 - volume control 2
- W, X**
- waking the computer 9, 10, 12.
 - See also* sleep
 - following low-power messages 51
 - troubleshooting 63
 - warranty on your computer 109, 113, 121
 - work space, arranging to prevent discomfort 105–106
 - wrist discomfort or pain from using computers 107
- Y**
- Y-adaptor for Ethernet/modem card 144–145
- Z**
- Zoomed Video PC Card 24, 25, 29



Macintosh PowerBook User's Manual

.....
*Includes setup, troubleshooting, and important health-related
information for Macintosh PowerBook G3 computers*

 Apple Computer, Inc.

© 1997 Apple Computer, Inc. All rights reserved.

Under the copyright laws, this manual may not be copied, in whole or in part, without the written consent of Apple. Your rights to the software are governed by the accompanying software license agreement.

The Apple logo is a trademark of Apple Computer, Inc., registered in the U.S. and other countries. Use of the “keyboard” Apple logo (Option-Shift-K) for commercial purposes without the prior written consent of Apple may constitute trademark infringement and unfair competition in violation of federal and state laws.

Every effort has been made to ensure that the information in this manual is accurate. Apple is not responsible for printing or clerical errors.

Apple Computer, Inc.
1 Infinite Loop
Cupertino, CA 95014-2084
408-996-1010
<http://www.apple.com>

Apple, the Apple logo, AppleShare, AppleTalk, Chicago, GeoPort, LaserWriter, LocalTalk, Mac, Macintosh, the Mac OS logo, PlainTalk, PowerBook, QuickDraw, and StyleWriter are trademarks of Apple Computer, Inc., registered in the U.S. and other countries.

Disk First Aid, Extensions Manager, and Finder are trademarks of Apple Computer, Inc.

Adobe, Adobe Illustrator, Adobe Photoshop, and PostScript are trademarks of Adobe Systems Incorporated, which may be registered in certain jurisdictions.

IrDA is a U.S.-registered trademark of the Infrared Data Association.

Linotype and Times are registered trademarks of Linotype-Hell AG.

PowerPC and the PowerPC logo are trademarks of International Business Machines Corporation, used under license therefrom.

Simultaneously published in the United States and Canada.

Other company and product names mentioned herein are trademarks of their respective companies. Mention of third-party products is for informational purposes only and constitutes neither an endorsement nor a recommendation. Apple assumes no responsibility with regard to the performance or use of these products.

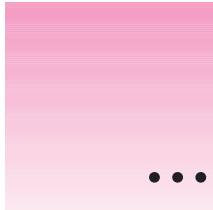

Contents



Communications regulation information vi

Laser information vii

Preface Welcome to PowerPC ix

1 Getting Started 1

Opening the display 3

Removing the battery's paper wrapper 4

Plugging in the computer 5

Turning the computer on 7

Problems turning the computer on? 8

Turning the computer off 9

Putting the computer to sleep 10

Restarting a computer that's already on 12

What's next? 13

2 Using Expansion Bay Modules and PC Cards 15

Using expansion bay modules 15

Using a CD in the CD-ROM drive 19

Locking an expansion bay module 23

Using PC Cards (PCMCIA cards) 24

| | | |
|----------|--|-----------|
| 3 | Connecting Additional Equipment | 31 |
| | Connecting a printer | 32 |
| | Connecting an external modem | 33 |
| | Connecting SCSI devices | 34 |
| | Using an external monitor | 39 |
| | Connecting sound input and output devices | 45 |
| | Connecting a mouse, keyboard, or other ADB device | 47 |
| | Connecting other devices | 47 |
| | Adding memory to your computer | 48 |
| | Using infrared file transfer | 48 |
| 4 | Power Management | 49 |
| | Power sources | 49 |
| | Monitoring the battery charge | 50 |
| | Recharging the battery | 53 |
| | Removing or replacing the battery | 54 |
| | Maximizing work time | 56 |
| 5 | Tips and Troubleshooting | 57 |
| | When you have questions | 57 |
| | When you run into trouble | 57 |
| | Problems starting up the computer | 58 |
| | Problems working with programs | 63 |
| | Other problems while working | 67 |
| | Problems with hardware | 70 |
| | Problems with equipment connected to your computer | 78 |
| | Problems with networks and file sharing | 79 |
| | Problems with Apple Remote Access | 82 |
| 6 | Diagnostic Techniques | 85 |
| | Checking your system software extensions | 85 |
| | Testing your hard disk | 87 |

| | | |
|-------------------|--|------------|
| | Reinstalling system software | 88 |
| | Restoring custom settings and special software | 89 |
| | Using a CD to start up your computer | 90 |
| | Installing Mac OS 8 | 91 |
| | Problems during installation | 97 |
| | Performing a clean installation | 99 |
| Appendix A | Health, Safety, and Maintenance Tips | 103 |
| | Health-related information about computer use | 103 |
| | Important care and safety instructions | 109 |
| | Caring for batteries | 110 |
| | Handling floppy disks | 111 |
| | Traveling with the Macintosh PowerBook | 112 |
| | Storing the Macintosh PowerBook | 113 |
| | Service and support | 114 |
| Appendix B | Using Your Keyboard | 115 |
| | Typing special characters and symbols | 117 |
| | Special key combinations | 119 |
| Appendix C | Installing a Macintosh PowerBook RAM Expansion Card | 121 |
| | Getting ready | 122 |
| | Installing the card | 123 |
| | Making sure the card is properly installed | 139 |
| Appendix D | Making Modem and Ethernet Connections to an Internal Expansion Card | 141 |
| | Connecting an Ethernet cable to the expansion card | 142 |
| | Connecting a telephone line to the expansion card | 143 |
| | Using Ethernet and a modem at the same time | 144 |
| | Index | 147 |

Communications regulation information

FCC declaration of conformity

This device complies with part 15 of the FCC rules. Operation is subject to the following two conditions: (1) This device may not cause harmful interference, and (2) this device must accept any interference received, including interference that may cause undesired operation. See instructions if interference to radio or television reception is suspected.

Radio and television interference

The equipment described in this manual generates, uses, and can radiate radio-frequency energy. If it is not installed and used properly—that is, in strict accordance with Apple’s instructions—it may cause interference with radio and television reception.

This equipment has been tested and found to comply with the limits for a Class B digital device in accordance with the specifications in Part 15 of FCC rules. These specifications are designed to provide reasonable protection against such interference in a residential installation. However, there is no guarantee that interference will not occur in a particular installation.

You can determine whether your computer system is causing interference by turning it off. If the interference stops, it was probably caused by the computer or one of the peripheral devices.

If your computer system does cause interference to radio or television reception, try to correct the interference by using one or more of the following measures:

- Turn the television or radio antenna until the interference stops.
- Move the computer to one side or the other of the television or radio.
- Move the computer farther away from the television or radio.
- Plug the computer into an outlet that is on a different circuit from the television or radio.
(That is, make certain the computer and the television or radio are on circuits controlled by different circuit breakers or fuses.)

If necessary, consult an Apple-authorized service provider or Apple. See the service and support information that came with your Apple product. Or, consult an experienced radio/television technician for additional suggestions.

IMPORTANT Changes or modifications to this product not authorized by Apple Computer, Inc., could void the FCC Certification and negate your authority to operate the product.

This product was tested for FCC compliance under conditions that included the use of Apple peripheral devices and Apple shielded cables and connectors between system components. It is important that you use Apple peripheral devices and shielded cables and connectors between system components to reduce the possibility of causing interference to radios, television sets, and other electronic devices. You can obtain Apple peripheral devices and the proper shielded cables and connectors through an Apple-authorized dealer. For non-Apple peripheral devices, contact the manufacturer or dealer for assistance.

Responsible party: Robert Steinfeld, Apple Computer, Inc., 1 Infinite Loop, Cupertino, CA 95014-2084, 408-974-2618.



Industry Canada statement

This Class B device meets all requirements of the Canadian interference-causing equipment regulations.

Cet appareil numérique de la Class B respecte toutes les exigences du Règlement sur le matériel brouilleur du Canada.

VCCI Class 2 statement

情報処理装置等電波障害自主規制について

この装置は、情報処理装置等電波障害自主規制協議会 (VCCI) の基準に基づく第二種情報技術装置です。この装置は、家庭環境で使用することを目的としていますが、この装置がラジオやテレビジョン受信機に近接して使用されると、受信障害を引き起こすことがあります。

取扱説明書に従って正しい取り扱いをしてください。

Laser information

WARNING Making adjustments or performing procedures other than those specified in your equipment's manual may result in hazardous radiation exposure.

WARNING Do not attempt to disassemble the cabinet containing the laser. The laser beam used in this product is harmful to the eyes. The use of optical instruments, such as magnifying lenses, with this product increases the potential hazard to your eyes. For your safety, have this equipment serviced only by an Apple-authorized service provider.

Your Power Macintosh computer is a Class 1 laser product. The Class 1 label, located in a user-accessible area, indicates that the computer meets minimum safety requirements. A service warning label is located in a service-accessible area. The labels on your product may differ slightly from the ones shown here.

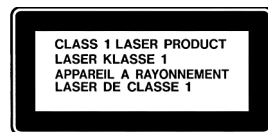

Class 1 label

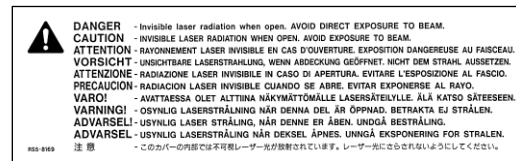

Service warning label

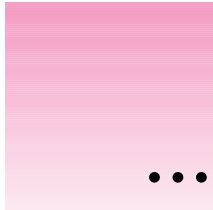

Welcome to PowerPC



Congratulations on the purchase of your new Macintosh PowerBook computer. Your computer is designed to give you the highest performance combined with real ease of use—it's easy to set up, easy to use, and easy to expand. This book will guide you through the setup procedure, tell you how to expand your computer, and provide many tips on using your new system.

Your computer is powered by the new **PowerPC**[™] microprocessor (or “chip”). This microprocessor was designed by Apple Computer, Inc., Motorola, Inc., and IBM Corporation. The **PowerPC** microprocessor uses Reduced Instruction Set Computing (RISC) technology to deliver very high performance at the lowest possible cost. The **PowerPC** RISC microprocessor represents the state of the art in microprocessor design.

Your new computer will run almost all your existing Mac OS software, but for best performance and greatest speed, look for the new software programs designed especially for computers with PowerPC microprocessors. You'll find these programs at any software store that carries Mac OS products.