

CHAPTER

1

# Setting Up Your Computer

The illustration on the next page shows all the equipment you need to set up your computer and begin using it. (Your monitor and keyboard may look slightly different.)

Before following the setup instructions in this chapter, Apple suggests that you read “Arranging Your Office” in the appendix for tips on adjusting your work furniture so that you’re comfortable when using the computer.

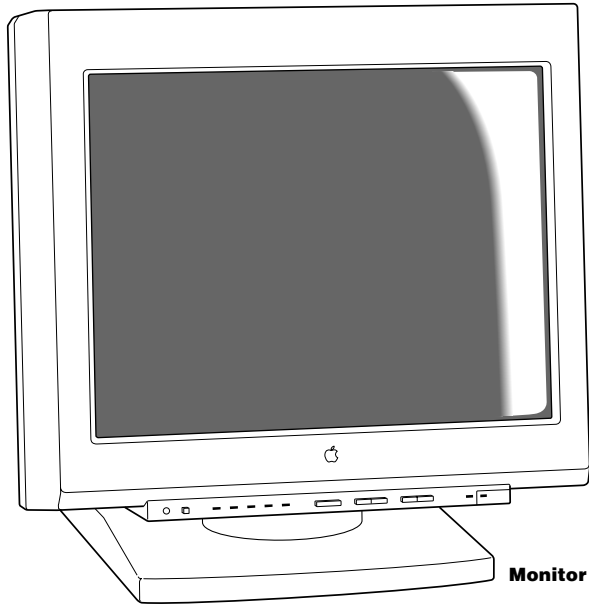

**Monitor**

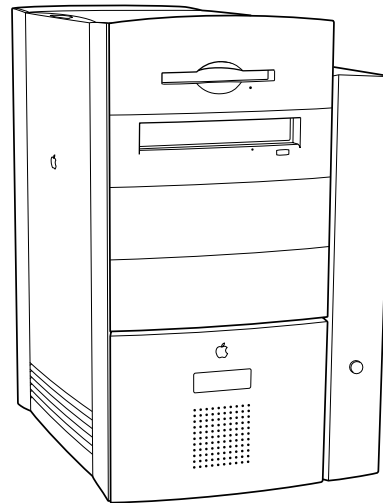

**Power Macintosh computer**

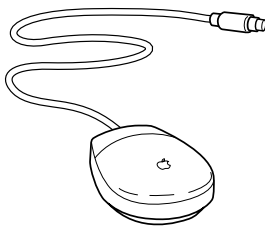

**Mouse**

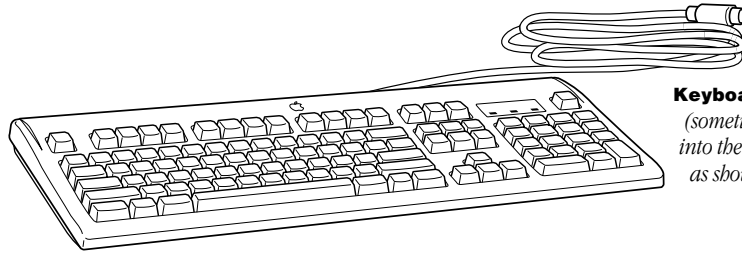

**Keyboard**

**Keyboard cable**  
*(sometimes built into the keyboard as shown here)*

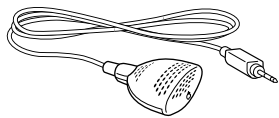

**Apple PlainTalk Microphone** *(optional)*

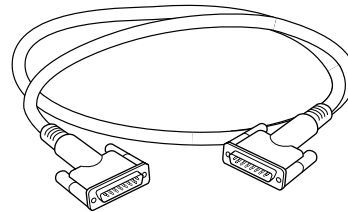

**Monitor cable**  
*(sometimes built into the monitor)*

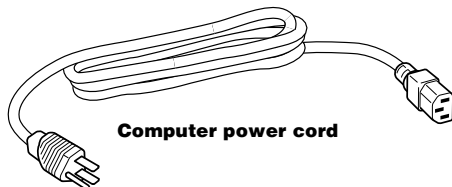

**Computer power cord**

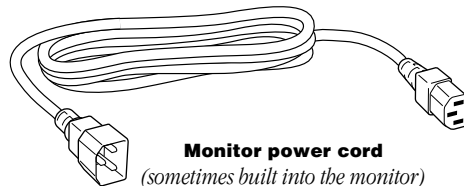

**Monitor power cord**  
*(sometimes built into the monitor)*

## Positioning and Plugging In the Computer

Place your computer on a sturdy, flat surface near a grounded wall outlet. Your computer is designed to be placed on the floor to conserve desk space, but you can place it on any stable, flat surface.

Before you plug your Macintosh into a wall socket, carefully read all the setup instructions in this chapter. Then, before you connect any other equipment to your Macintosh, follow the instructions in this section to plug it in. The plug grounds the computer and protects it from electrical damage while you set up. When you are ready to begin setting up, follow these steps:

- 1 Make sure the voltage switch on the back of the computer is set for the kind of voltage system to which you will be connecting.

The voltage switch must be set correctly to avoid damaging your computer. An adhesive label showing how to set the voltage may partly cover the voltage switch and power socket. Remove the label. If you don't know the voltage used in the country you're in, look at the table "Voltage Switch Settings for Different Locations" on the next page.

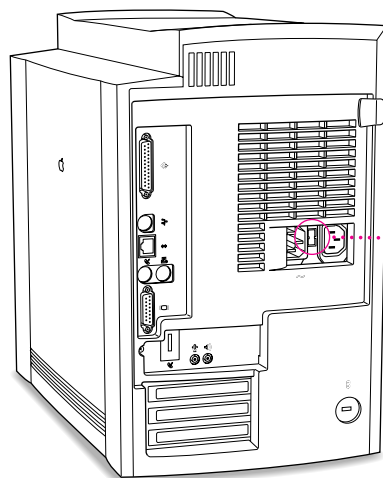

*Check to see that the voltage switch on the back of your computer is properly set before you plug it in. If you need to change the setting, insert a small screwdriver in this slot and slide the switch.*

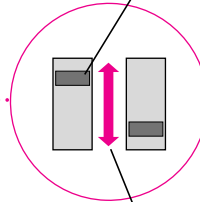

*Set the switch to show "115" for AC voltages in the 100–120V range. Set the switch to show "230" for AC voltages in the 200–240V range.*

### Voltage switch settings for different locations

Country	Switch setting
Bermuda, Canada, Jamaica, Japan, Mexico, Philippines, Puerto Rico, Saudi Arabia, Taiwan, United States, Venezuela	115
Bahrain, Brazil, France, Indonesia, Italy, Lebanon, Peru, South Korea, Spain <sup>1</sup>	115 or 230
Australia, Austria, Belgium, Chile, China (People's Republic), Czechoslovakia, Denmark, Egypt, Finland, Germany, Greece, Greenland, Hong Kong, Hungary, Iceland, India, Iran, Israel, Jordan, Kuwait, Liechtenstein, Luxembourg, Malta, Nepal, the Netherlands, New Zealand, Northern Ireland, Norway, Oman, Pakistan, Papua New Guinea, Paraguay, Poland, Portugal, Qatar, Romania, Russia and the Commonwealth of Independent States (CIS), Singapore, South Africa, Sweden, Switzerland, United Arab Emirates, United Kingdom, Yemen, Yugoslavia	230

<sup>1</sup> These countries employ more than one type of power source voltage. Ask your local power provider which switch setting to use for your city or region.

- 2 Plug the socket end of the computer's power cord into the recessed power socket (marked with the symbol  $\sim$ ) on the back of the computer.

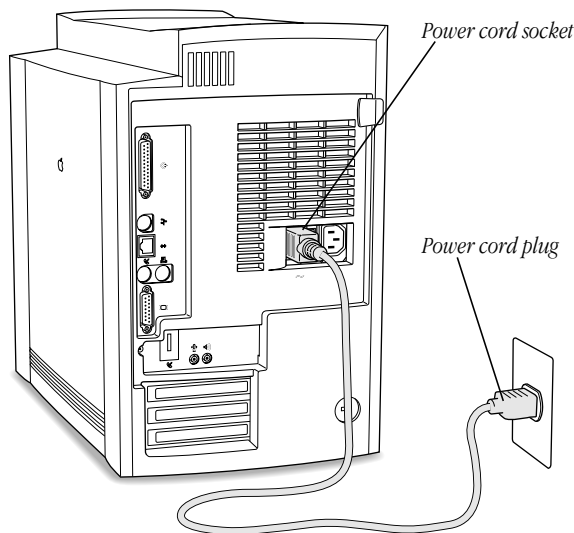

- 3 Plug the other end of the power cord into a three-hole grounded outlet or power strip.

**Important** Make sure you can easily reach the plug to disconnect the computer in an emergency. The only way to completely disconnect power from the computer is by unplugging one end of the power cord from the outlet or power strip or from the back of the computer.

**Warning** Be sure to set the voltage switch on the back of your computer for the voltage system to which you're connecting.

This equipment is intended to be electrically grounded. Your Macintosh is equipped with a three-wire grounding plug—a plug that has a third (grounding) pin. This plug will fit only a grounded AC outlet. This is a safety feature. If you are unable to insert the plug into the outlet, contact a licensed electrician to replace the outlet with a properly grounded outlet. Do not defeat the purpose of the grounding plug!

## Connecting a Monitor

You can connect many types of monitors to your Macintosh computer. This section contains instructions for connecting most monitor types. (Also look at the instructions that came with the monitor.)

**Note:** If you are connecting an Apple monitor that has built-in speakers or a microphone, you may need to install monitor software after you have set up and turned on your computer. Otherwise, you may not be able to use all the monitor's features. See the instructions that came with the monitor for more information. Also check the Read Me file on the computer's hard disk for any additional instructions regarding the installation of monitor software.

To connect the monitor, follow these steps:

- 1 Place the monitor near the computer.

For more detailed information about positioning and handling your computer equipment, consult "Arranging Your Office" in the appendix.

- 2 Connect the monitor power cord to the monitor.

Some monitors already have the cord attached.

- 3 Plug the power cord into a grounded electrical socket or the back of the computer.

Check the information that came with the monitor to find out if it must be plugged into the back of your computer or into a grounded wall outlet.

**Warning** The monitor power socket on the back of the computer uses the same voltage level as the electrical outlet to which the computer is connected. To protect your monitor, be sure to use the appropriate adapter or voltage converter, if one is necessary.

- 4 Attach the monitor cable to the monitor; then attach the monitor cable to the monitor port on the back panel of the computer.

Some monitors already have the cable attached.

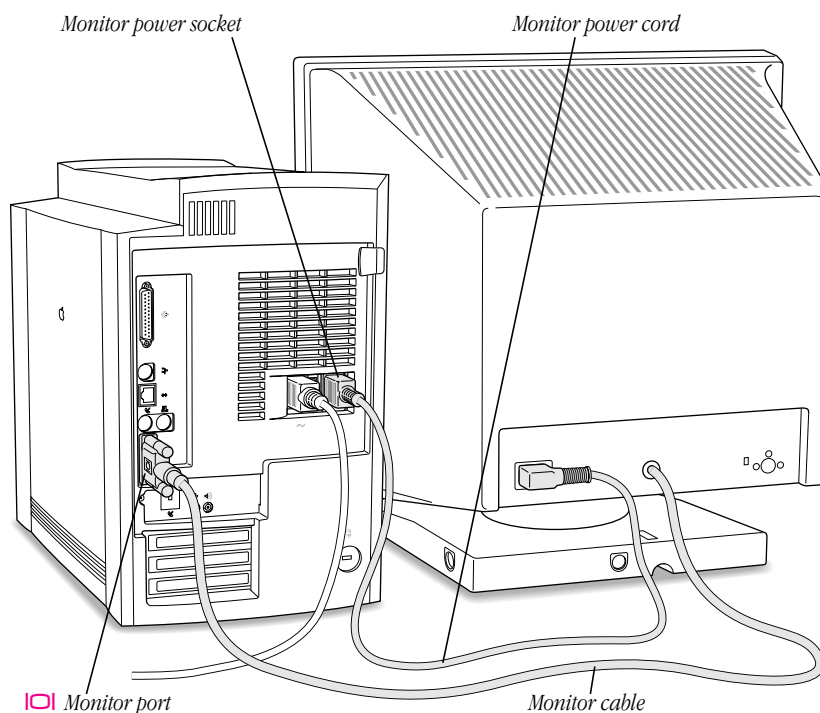

## Connecting the Mouse and the Keyboard to the Computer

- 1 Plug the mouse cable into the keyboard.

The mouse and keyboard cables connect via ADB ports, which are marked with the icon . The plugs at the ends of the cables also have the icons. Align the icons on the port and the plug before you insert the plug.

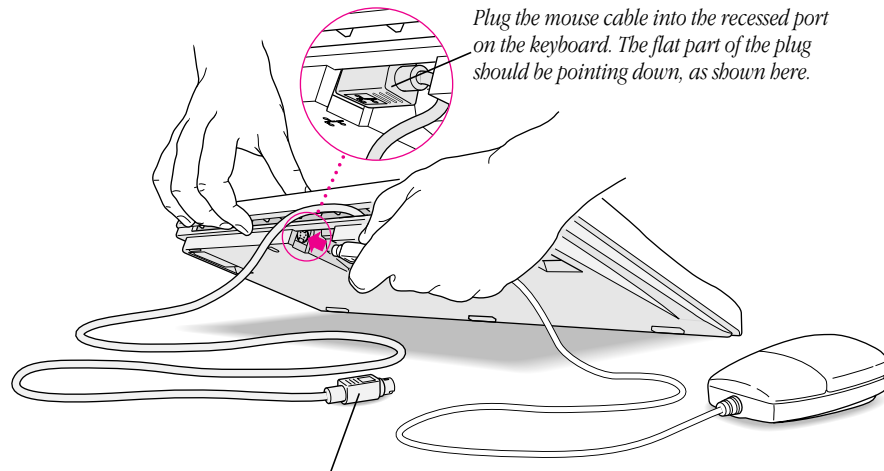

*Plug the mouse cable into the recessed port on the keyboard. The flat part of the plug should be pointing down, as shown here.*





*This cable plugs into the Apple Desktop Bus (ADB) port, marked with the  icon, on the back of the computer. You may also be able to connect the cable to an ADB port on the monitor.*

The position of the port and the icon on your keyboard may be different from those pictured here. Some keyboards, like the one shown here, have only one ADB port, which is recessed on the back. Other keyboards have two ADB ports: one on each side of the keyboard. If you have the second kind of keyboard, plug in the mouse on the side that makes it most comfortable for you to use. Most right-handed people prefer to use the mouse with their right hand and plug the mouse into the right ADB port.

- 2 If your keyboard has a second ADB port, plug the keyboard cable into it.

The keyboard cable has ADB plugs at both ends. Plug either end of the cable into the free ADB port.

If your keyboard has a built-in cable (like the one pictured above), skip this step.

- 3** If the front or side of your monitor has a port marked with the  icon, plug the keyboard cable into this port. Otherwise, plug the keyboard cable into the port marked with the  icon on the back of the computer.
- 4** If you plugged your keyboard into the monitor in step 3, connect an ADB cable between the monitor and the computer. (Otherwise, skip to step 5.) Monitors may include one of two types of ADB cables:
  - A separate ADB cable that you connect between the ports marked with the  icon on the back of the monitor and on the computer.
  - An ADB connector on the monitor cable that you connect to the port marked with the  icon on the back of the computer.

For more information about ADB connections between the monitor and the computer, see the manual that came with your monitor.

- 5** Adjust the keyboard for your comfort.

Some keyboards, like the one pictured here, have feet underneath that you can snap into position. Other keyboards have a bar on the back that slides to change the angle.

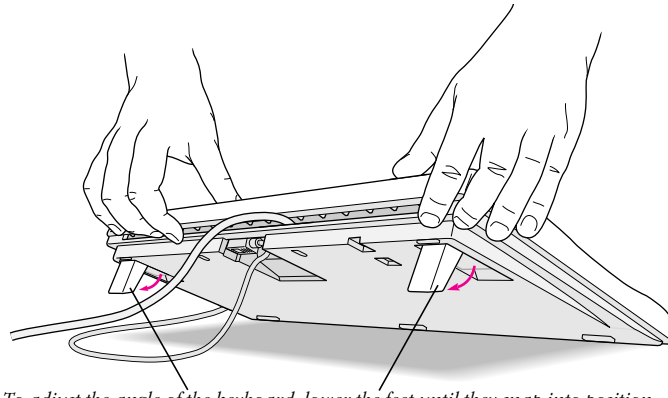

*To adjust the angle of the keyboard, lower the feet until they snap into position.*



## Connecting a Modem

Some Macintosh models come with an internal modem already installed in the computer. If your computer did not come with an internal modem, you can attach an external modem.

**Important** When connecting a modem, make sure you connect the modem to an analog phone line—the kind used typically in homes.

If your computer came with an internal modem, you only need a telephone cable to connect it to a phone line. Plug one end of the telephone cable into the internal modem port (☎) provided on the back of the computer by the modem and the other end into the telephone jack in the wall.

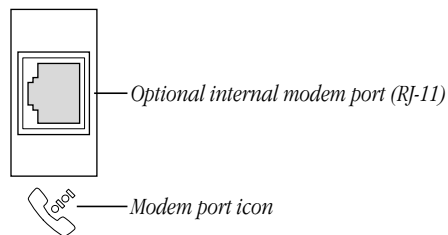

You connect an external modem to the modem (☎) port on the back of the computer.

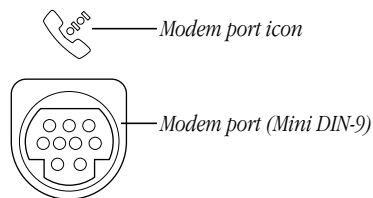

Before you attach an external modem, read any instructions that came with it. These may include instructions for installing the modem's software.

**Important** Disconnect your modem from the phone jack during lightning storms. This will prevent a destructive voltage overload from damaging the modem.

## Turning the Computer On

To turn on the computer for the first time, follow these steps:

- 1 Turn on your monitor.

See the information that came with your monitor for the location of the power switch. On newer Apple monitors, the power switch is located on the front.

You may not see the monitor power come on until you turn on the computer in the next step.

**By the way:** Depending on the type of monitor you have, you may only need to turn it on once. Some monitors turn off automatically when you shut down the computer and turn on automatically when you start up the computer. You turn other monitors on or off separately.

- 2 Turn on your computer by pressing the Power key.

The Power key is marked with a triangle on your keyboard.

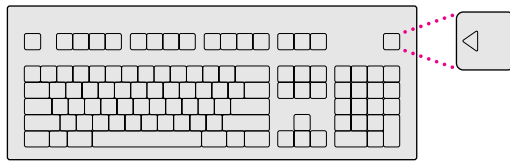

You should hear a tone from the computer as it starts up. If you don't, press the Power key again and hold down the key a little longer.

As the computer starts up, a series of messages appear on the screen.

When the computer starts up, go to the section "What's Next?" for more instructions.

If the computer does not start up, go to the next section, "Problems Turning Your Computer On?"

## Problems Turning Your Computer On?

If you don't see anything on your screen or you think your computer did not start up properly, check these items to see if you can identify the problem:

- Is the computer plugged into a power source? If it is plugged into a power strip, is the power strip turned on?
- Are the keyboard and mouse cables connected correctly? If your keyboard is attached to the monitor, does an ADB cable connect the monitor to the computer?

**Warning** Don't connect or disconnect this cable while the computer is on. You could damage your equipment. To turn off your computer, press the power button on the front of the computer.

- Is the computer turned on? The power-on light on the front panel of the computer should be on.
- Is the monitor power cord plugged in?
- Is the monitor cable—the one connected to the monitor port (IO) on your computer—attached firmly to both the monitor and computer?
- Is the monitor turned on? (Check the power-on light on the front of the monitor.)
- Is the brightness control on the monitor adjusted correctly? (On most monitors, the brightness control is marked with the symbol ☼.)
- Is the computer asleep? A blinking green light on the computer's front panel means that it has gone into "sleep," a low-power mode designed to save energy. To wake the computer, press the Power key (marked with a <img alt="power key symbol" data-bbox="245 535 255 545"/>) on the keyboard. It may take a moment or two for the computer to wake up. (Unless you change the settings, the computer goes to sleep if it is not used for 30 minutes.)
- If you see a blinking question mark on the monitor screen or hear an unusual "breaking glass" sound when you turn on the computer, see the *Emergency Handbook* for help.

## What's Next?

For more information about working with your computer's hardware, refer to the following chapters in this manual.

- To learn more about the basics of your computer's hardware, such as how to use your built-in CD-ROM and floppy disk drives, how to connect external devices such as a printer, and how to attach a security device to protect against theft, go to Chapter 2.
- To learn how to connect your computer to a computer network, see Chapter 2.
- To learn how to install expansion cards or add memory to your computer, see Chapter 3.

If you want to turn off your computer for now, go to the next section, "Turning the Computer Off."

## Turning the Computer Off

To turn your computer off, follow these instructions:

- 1 Press the Power key (⏻) on your keyboard.

The following dialog box appears on the screen:

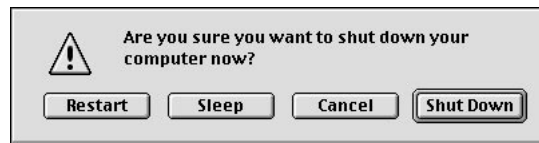

- 2 Press the Return key on the keyboard (or click the Shut Down button in the dialog box).

If any applications are still open, a message asks if you want to save your work before the computer shuts down.

To turn the computer on again, just press the Power key on the keyboard.

**Note:** You can also turn off the computer by choosing Shut Down from the Special menu.

**Important** Do not use the power button on the front of the computer to turn the computer off unless there is a problem that prevents it from being turned off with the Power key or the Shut Down command. (You could lose unsaved work.) To make sure your work is saved, use the Power key.

## Using Your Macintosh and Connecting Additional Equipment

This chapter tells you about the disk drives built into your computer and how you can expand your computer system by connecting other equipment to it or by connecting it to a computer network. The illustrations on the next two pages show the built-in drives and connectors for additional equipment.

This chapter describes how to connect the following types of additional equipment:

- audio devices, such as a microphone, headphones, or speakers
- video devices, such as a video camera or videocassette recorder (VCR)
- external SCSI devices, such as a hard disk or a removable media drive
- a printer
- a second monitor
- additional ADB input devices, such as a trackball or a graphics tablet
- network cables and adapters
- security equipment to protect your Macintosh

**Important** Each device you add should be compatible with your computer and must not exceed the maximum power allowance for that device. Turn off the computer before connecting a SCSI or ADB device. For more information, consult an Apple-authorized dealer, the manufacturer of the equipment you add, or the *Technical Information* booklet that came with your computer.

For instructions on installing internal equipment, see Chapter 3, “Installing PCI Cards, Memory, and Internal Storage Devices.”

## Your Computer's Components and Front Panel Controls

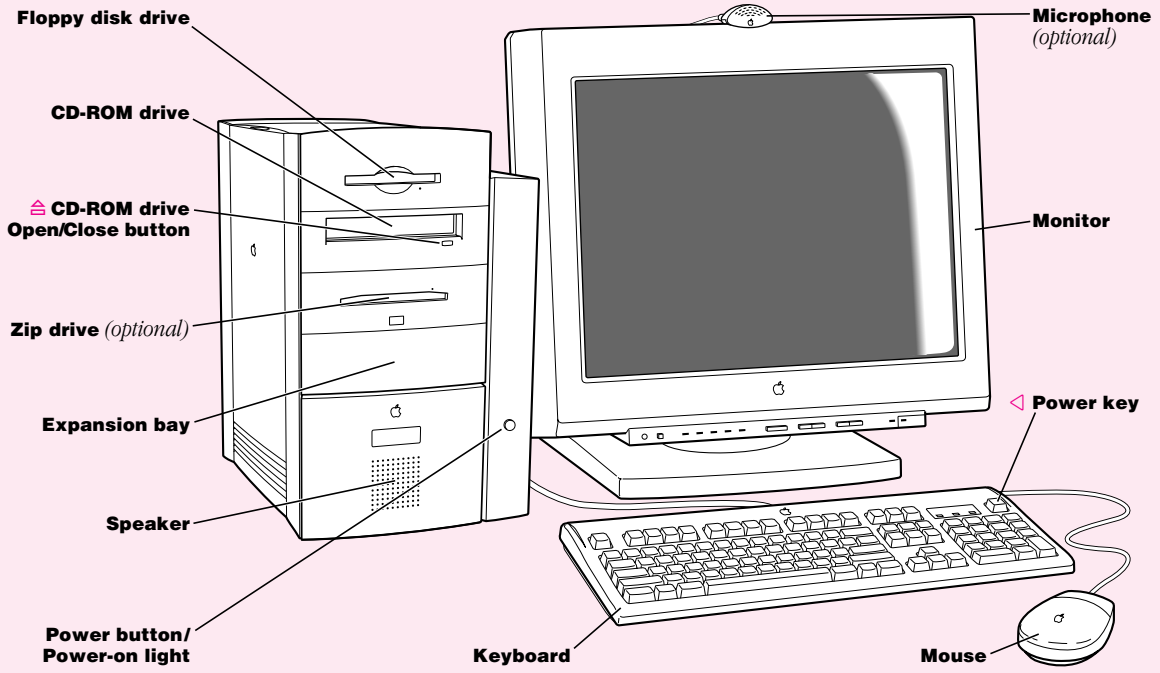

---

**Floppy disk drive**

Works with high-density and double-sided 3.5" floppy disks

**CD-ROM drive**

Works with CD-ROM discs and plays standard audio and Photo CDs

 **CD-ROM drive Open/Close button**

Opens and closes the CD-ROM drive tray

**Zip drive (optional) or expansion bay 1**

Works with Zip disks. If a Zip drive is not present, then this is an expansion bay for an additional 3.5" or 5.25" internal storage device that is up to 1.625" (41.3 mm) high.

**Expansion bay 2**

Behind the front panel there is an expansion bay for an additional 3.5" or 5.25" internal storage device that is up to 1.625" (41.3 mm) high.

**Power button/Power-on light**

Turns your computer off in emergencies when you can't use the Power key on the keyboard or the Shut Down command in the Special menu. A green light indicates that the computer is on. The light blinks when the computer is asleep.

**Monitor**

Your monitor may look different. An Apple display is shown here.

 **Power key**

Turns your computer on and off

---

## Your Computer's Ports and Connectors

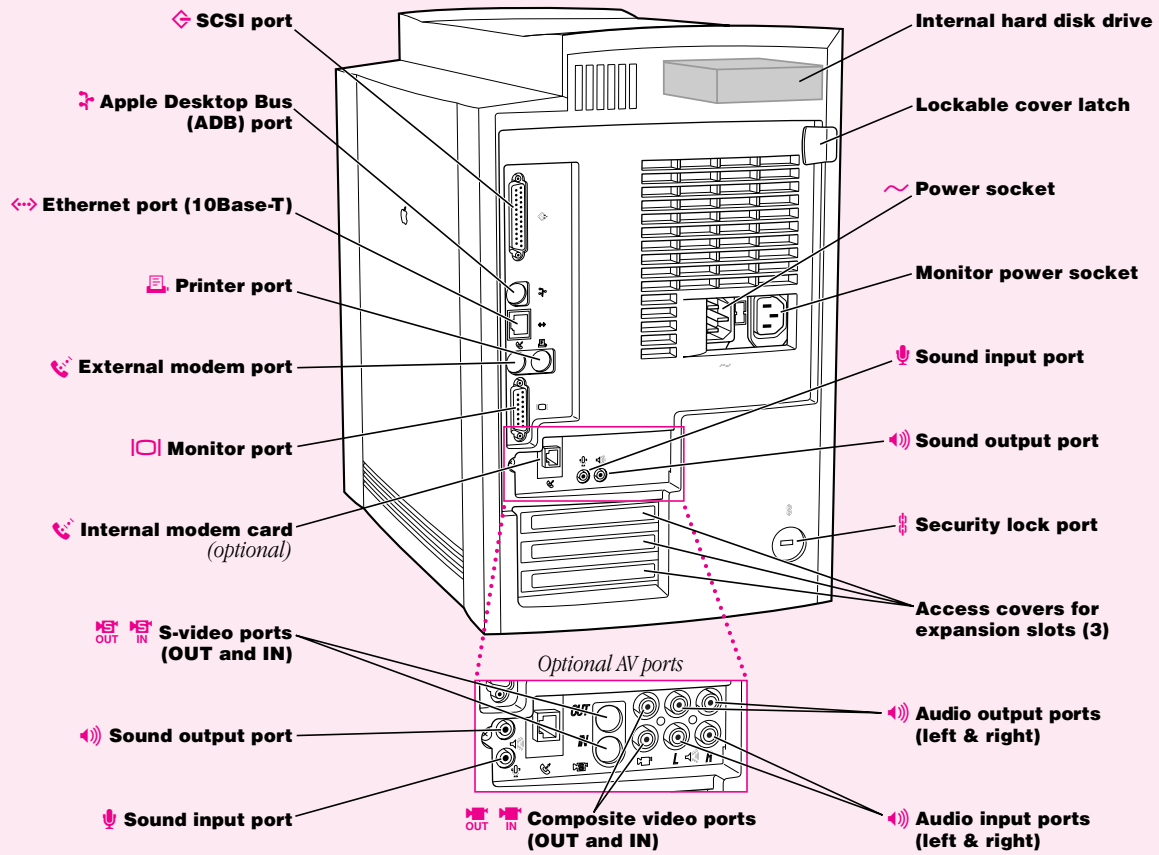



---

**Standard ports and connectors (available on all models)****SCSI port**

Connects your Macintosh to SCSI equipment such as external hard disk drives and scanners

**Apple Desktop Bus (ADB) port**

Connects your Macintosh to an input device, such as a keyboard or a trackball

**Ethernet port (10Base-T)**

Connects your Macintosh to a high-speed 10Base-T Ethernet network

**Printer port**

Connects your Macintosh to a printer or LocalTalk network

**External modem port**

Connects an external modem cable or LocalTalk cable to your Macintosh

**Monitor port**

Connects your Macintosh to a monitor

**Access covers for expansion slots (3)**

Your Macintosh supports up to three peripheral component interconnect (PCI) cards.

**Internal hard disk drive**

Large-capacity permanent device for storing software, documents, and other files

**Security lock port and lockable cover latch**

You can attach a security lock to your Macintosh and to its cover to secure the internal components. See your computer products retailer for security lock devices that work with your computer.

**Sound output port**

Connects your Macintosh to headphones, externally powered (amplified) speakers, or other audio output equipment

**Sound input port**

Connects your Macintosh to an Apple PlainTalk microphone or other audio input equipment

---

**Optional ports and connectors (available on some models)****S-video ports (IN and OUT)**

Connects your Macintosh to VCRs, video cameras, or other video equipment that uses an S-video connector

**Audio input ports (left & right)**

Connects your Macintosh to the RCA-type audio output ports of video or audio equipment, such as VCRs and tape decks

**Composite video ports (IN and OUT)**

Connects your Macintosh to most VCRs, laserdisc players, video cameras, and other video equipment

**Audio output ports (left & right)**

Connects your Macintosh to the RCA-type audio input ports of video or audio equipment, such as VCRs and tape decks

**Internal modem port**

Connects a telephone cable to the optional internal modem

---

## Using the Computer's Built-in Drives

Follow these instructions to work with the computer's built-in CD-ROM drive, floppy disk drive, and optional Zip drive.

### Using the CD-ROM Drive

To use your CD-ROM drive, follow these instructions.

#### Inserting a CD-ROM Disc

- 1 Press the Open/Close button next to the CD-ROM drive.
- 2 Place a CD-ROM disc in the tray, with the disc label facing up.  
Make sure that the disc lies flat in the tray.  
If you are using a small (8 cm) disc, center the disc in the tray's inner ring.
- 3 Gently push the tray in, or press the Open/Close button, to close the tray.  
In a moment an icon for the CD-ROM disc appears on your screen.

#### Ejecting a CD-ROM Disc

Apple recommends that you eject your CD-ROM disc before you shut down the computer.

To eject a CD, follow these instructions.

- 1 Quit all the application programs running from the CD.
- 2 Select the disc's icon and drag it to the Trash.  
The CD tray opens.
- 3 Remove the disc and gently close the tray.

You can also eject a CD-ROM disc from the drive by selecting the CD's icon, opening the File menu, and choosing the Put Away command or by opening the Special menu and choosing the Eject command.

If these methods don't work, see Mac OS Help, available in the Help menu.

If problems arise while using your CD-ROM drive, the *Emergency Handbook* that came with your computer contains solutions.

## Using the Floppy Disk Drive and Optional Zip Drive

You can use the floppy disk drive and the optional Zip drive to back up important data and to transfer files between computers. The floppy disk drive accepts only 3.5-inch floppy disks. Although the floppy disks and Zip disks are different, you work with them in the same way. Be sure to use the right kind of disk in each drive.

**Important** Never force a Zip disk into or out of the drive. Never use ordinary 3.5-inch floppy disks or floppy disk cleaning disks in the Zip drive. They will damage the drive.

For information on using the floppy disk drive, see Mac OS Help (available in the Help menu). The appendix of this manual has information on handling floppy disks and Zip disks. If you are unable to eject a disk, see the *Emergency Handbook* that came with the computer.

For more information on using the optional Zip drive and disks, see the Iomega folder in the Apple Extras folder on your computer's hard disk.

## Connecting Audio Equipment

Your Macintosh can play and record stereo sound from a variety of sources. Your computer has sound input and output ports (also known as “jacks”) like those found on most Macintosh models. Some models also have RCA-type audio input and output ports.

### The Sound Input and Output Ports

Your Macintosh can receive stereo sound from a sound input device—also called a sound source—such as a microphone, tape deck, or audio CD player.

You attach sound input devices to the sound input port, which is marked with an icon of a microphone (🎤).

Your computer comes with a built-in speaker. You can attach another sound output device, such as amplified speakers or headphones.

You attach sound output devices to the sound output port, which is marked with an icon of headphones (🎧) or a speaker (🔊).

The illustration of the back of the computer in the beginning of this chapter shows where these ports are.

**Note:** Depending on the computer configuration you purchased, your computer's back panel may have additional ports alongside the sound input and sound output ports.

The sound input and output ports accept 3.5-mm connectors. There are two types:

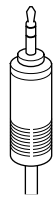

*Stereo miniplug*



*Extended miniplug*

- The stereo miniplug is found most often on stereo equipment; it works in both the sound input and sound output ports.
- The extended miniplug, which is slightly longer and is found on voice-quality microphones (such as the Apple PlainTalk Microphone), works only in the computer's sound input port (🎤). (Even though it will fit into the sound output port, it won't work there.)

If your equipment has a different connector from those shown here, you can purchase an adapter at an electronics supply store.

### The Optional Left and Right RCA-Type Audio Ports

Some models of this Macintosh also have ports that accept left and right input and output through RCA-type connectors. These connectors are found on devices like videocassette recorders (VCRs) and tape decks. The RCA-type ports are color-coded: red for right, and white for left. (The yellow ports are for connecting video equipment.)

#### 🔊 Sound output port

Connect your Macintosh to headphones, externally powered (amplified) speakers or other audio equipment using a 3.5-mm miniplug connector

#### 🔊 Audio output ports (left & right)

Connect your Macintosh to the RCA-type Audio In ports of video or audio equipment such as VCRs and tape decks

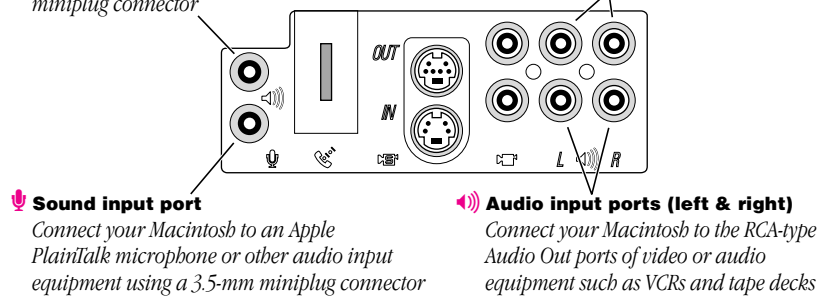

#### 🎤 Sound input port

Connect your Macintosh to an Apple PlainTalk microphone or other audio input equipment using a 3.5-mm miniplug connector

#### 🔊 Audio input ports (left & right)

Connect your Macintosh to the RCA-type Audio Out ports of video or audio equipment such as VCRs and tape decks

The left and right RCA-type ports accept this type of connector:

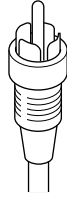

*RCA-type plug*

If your equipment has a different type of connector, you can purchase an adapter at an electronics supply store.

### Connecting Most Audio Equipment

To connect most audio equipment, follow the steps below. For specific instructions on connecting a microphone, skip to the next section, “Connecting and Using a Microphone.”

- 1 Make sure that the audio equipment has a cable with a stereo miniplug connector.

You can use a cable that looks like one of these:



If your computer has the optional RCA-type audio ports, you can also use a cable like this one that has two RCA plugs at each end:

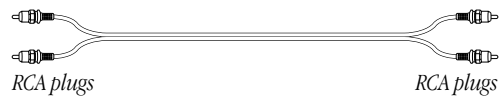

- 2 Shut down the computer, turn off the audio equipment, and place the equipment near the computer.
- 3 Attach cables to the audio equipment following the instructions that came with the equipment. Some equipment (such as most headphones) comes with cables already attached.

- 4 If your audio equipment is a sound input device, such as a tape deck, audio CD player, or VCR, attach it to the sound input port (🔊) or to the optional RCA-type left and right audio input ports (🔊).
- 5 If your audio equipment is a sound output device, such as headphones or amplified speakers, attach it to the sound output port (🔊) or to the optional RCA-type left and right audio output ports (🔊).

The illustration below shows two typical cable arrangements, one for amplified speakers connected with stereo miniplug connectors, and one for a tape deck connected with RCA-type connectors.

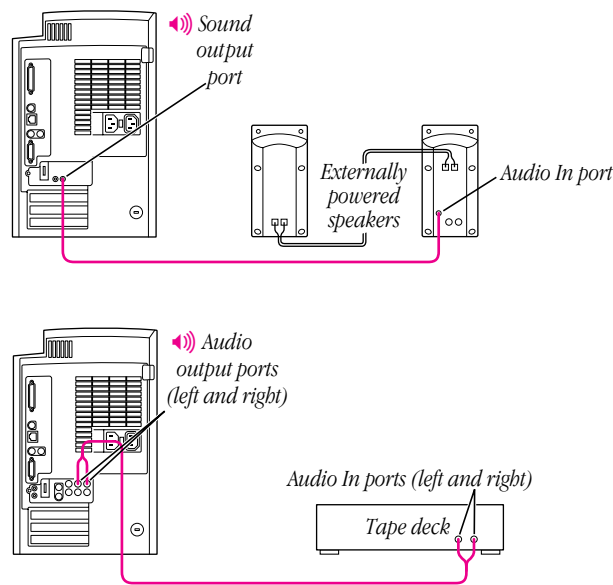

In the first example, the two speakers are joined to each other by standard speaker wires. Some speaker pairs have two cables (one per speaker), which must be joined by a dual-plug adapter before they can be attached to the computer's sound output port.

- 6 Turn on the computer and the audio equipment.

If your monitor has sound controls, use them to adjust the sound. You may also need to adjust the settings in the Monitors & Sound control panel. Open the Monitors & Sound control panel and click the Sound button.

## Connecting and Using a Microphone

You can use the Apple PlainTalk Microphone that comes with some Macintosh computers (or a compatible line-level microphone) to give spoken commands to your Macintosh and to record your voice or other sounds. (The illustration of your computer in Chapter 1 shows the Apple PlainTalk microphone.)

**Note:** Do not use the Apple Omni microphone (the round microphone supplied with some older Macintosh models) or the attenuated RCA adapter provided with some Macintosh computers.

If your monitor has a built-in microphone that you want to use, see the information that came with the monitor to connect the microphone.

To connect and position an external microphone, follow these steps:

- 1** Shut down the computer and plug the microphone's connector into the sound input port (🎧) on the back of the computer.
- 2** Place an Apple PlainTalk Microphone at the top center of the monitor, so that the microphone's Apple (🍏) icon faces you.

If you're using a different microphone, position it according to these guidelines:





- The microphone should be between 1 and 3 feet away from you.
  - The microphone should be directly in front of you to minimize the effect of background noises.
- 3** Turn on the computer.
  - 4** Open the Monitors & Sound control panel, click the Sound button, and make sure that the microphone is the selected sound input source.

Click the button labeled ? for help.

## Connecting Video Equipment

Some models of this Macintosh have ports for connecting video equipment so that you can view TV and other video images on your computer monitor and store the images on your hard disk. You can also view the Macintosh desktop on a television screen attached to the computer and record images from the desktop to a videocassette recorder (VCR).

Your Macintosh can work with two major video formats:

- Composite video, which is used by most televisions, most VCRs, and laserdisc players. Composite video devices plug into the computer's RCA-type video ports ( **OUT** and  **IN**).
- S-video, which is a high-quality video format used by many video cameras, VCRs, and televisions. S-video devices plug into the computer's S-video ports ( **OUT** and  **IN**).

The illustration below shows the computer's video input and output ports. (The RCA-type ports are color-coded: yellow for composite video, red for right audio, and white for left audio.)

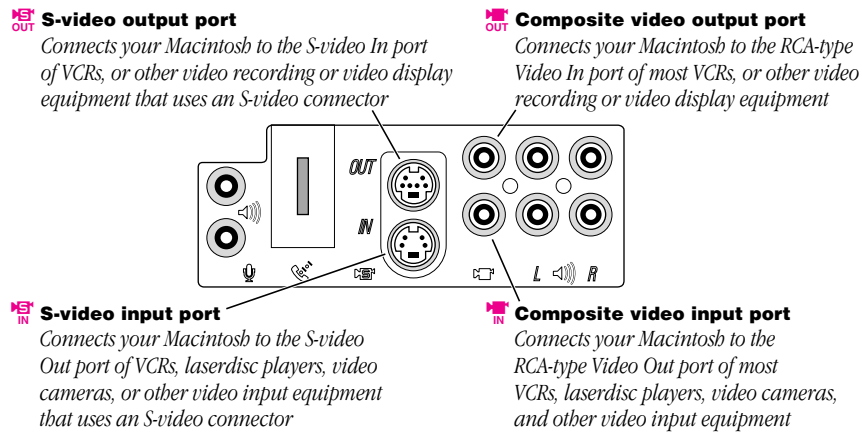

The S-video input and output ports accept S-video connectors, and the composite video input and output ports accept RCA-type connectors.

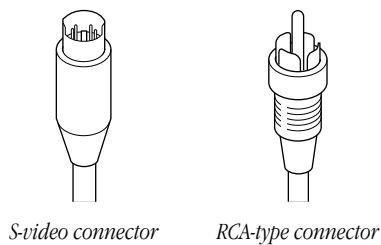

**Note:** The S-video input port is compatible with both seven-pin and four-pin S-video connectors.



**Important** The S-video connector is a round plug with several small metal pins, which resembles other Macintosh connectors, such as those for a printer, modem, mouse, or keyboard. Don't confuse the connectors; they're not interchangeable.

Depending on what kind of ports are available on your video equipment, you'll need different cables (available at an electronics supply store).

- If your equipment has an S-video Out port, you'll need a video cable with S-video connectors at each end, and two audio cables with RCA-type connectors at each end. (The audio cables can be separate, or joined like the one in the illustration.)

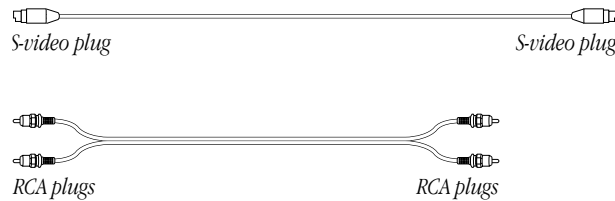

- If your equipment has an RCA Video Out port, you'll need one video cable with RCA-type connectors (plugs) at each end, and two audio cables with RCA-type connectors at each end. (The cables can be separate, or joined like the one in the illustration.)

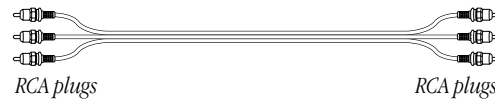

### Connecting Video Equipment for Input to the Computer

When you connect video equipment to the video input port on your computer, you can view video on your monitor, capture video images, and hear the sound from the video equipment through the computer's speaker. The instructions that follow are for connecting a stereo VCR and video camera, but you can use them as a model for connecting your computer to any video equipment.

To connect a VCR or video camera for input, do the following:

- 1** Shut down the Macintosh and turn off the VCR or video camera.
- 2** Attach one end of the video cable to the Video Out port on the video equipment.

Follow the directions that came with the VCR or camera.

- 3 Plug the other end of the video cable into either the S-video input port (Ⓜ) or the yellow RCA Video input port (Ⓜ) on the Macintosh.

If the S-video connector doesn't slide easily into the port, check the pin alignment and try again. Don't use force, which could damage the computer or cable.

- 4 Plug the RCA-type connectors on the audio cables into the left and right RCA Audio Out ports on the VCR or camera.
- 5 Plug the RCA-type connectors on the audio cables into the left and right RCA input ports (Ⓜ) on the computer.

If the cable is color-coded, the red connector is for the right port, and the black or white connector is for the left port.

The next four illustrations show S-video connections and composite video connections for both a VCR and a camera. Your finished connections should look like one of the following:

#### S-video connection for input from a VCR

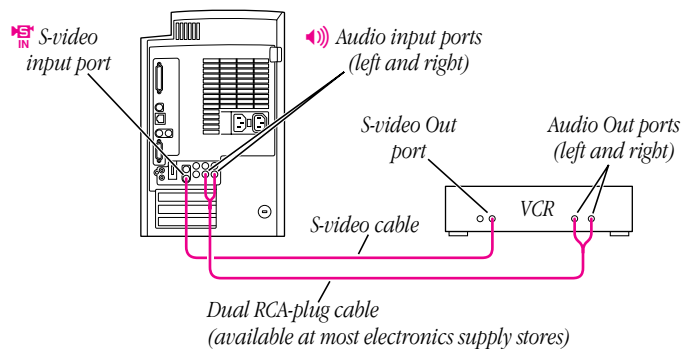

#### Composite video connection for input from a VCR

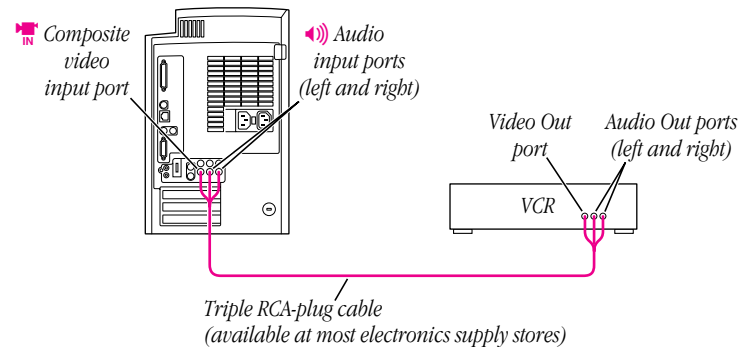

### S-video connection for input from a camera

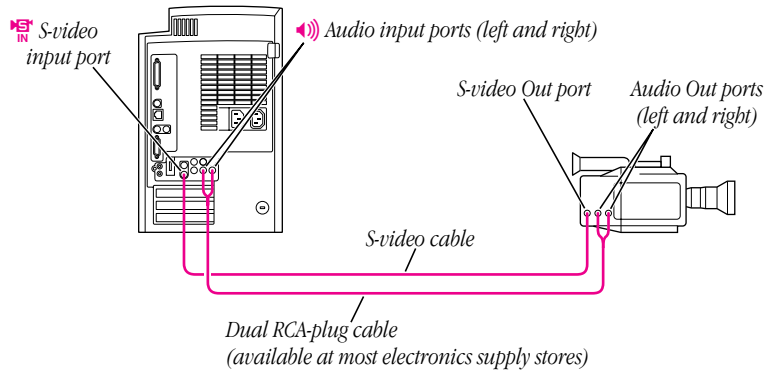

### Composite video connection for input from a camera

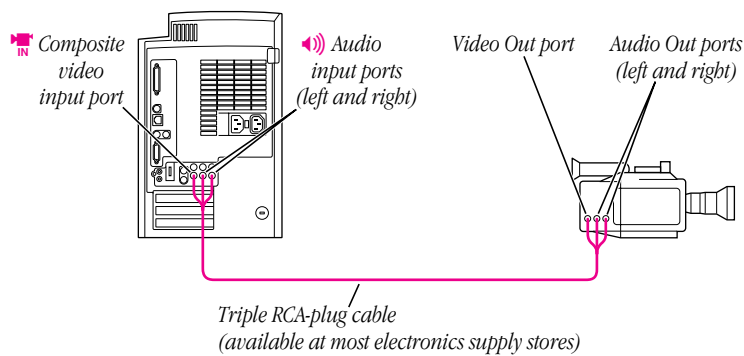

- 6** Turn on the computer and the VCR or camera.
- 7** To hear or capture on your computer the audio coming into the RCA input ports, open the Monitors & Sound control panel, click the Sound button, and make sure that the RCA input ports are the selected sound input source.

Click the button labeled  for help.

You can now begin working with the video equipment connected to your computer. To learn more about using the AV features of your computer to play or capture video on your computer, open Mac OS Help (available in the Help menu) and look up "video" in the index.

## Connecting Video Equipment for Output From the Computer

You can connect a VCR to record computer images and audio on videotape. The VCR records what is happening on the computer's monitor, sounds generated by the computer, and speech spoken into a microphone if one is connected. This capability is useful for creating video presentations or software demonstrations.

**Note:** The video out ports are primarily intended for recording what is happening on the computer's monitor. You can use video-editing software to save captured and edited video on a VCR if the video-editing software supports the use of a single monitor. However, to get full video-editing support with independent monitor and video (or TV) output, you need to purchase and install a third-party video capture PCI card.

To connect a VCR for output from the computer, do the following:

- 1 Shut down the Macintosh and turn off the VCR.
- 2 Attach one end of the video cable to the Video In port on the VCR.  
Follow the directions that came with the VCR.
- 3 Plug the other end of the video cable into either the S-video output port (S) or the yellow composite video output port (Y) on the Macintosh.

If the S-video connector doesn't slide easily into the port, check the pin alignment and try again. Don't use force, which could damage the computer or cable.

- 4 Plug the RCA-type connectors on the audio cables into the left and right Audio In ports on the VCR.
- 5 Plug the RCA-type connectors on the audio cables into the left and right audio output ports (L and R) on the Macintosh.

If the cable is color-coded, the red connector is for the right port, and the black or white connector is for the left port.

Depending on whether your equipment has S-video or composite video (RCA-type) ports, your finished connections should look like one of the following:

**S-video connection for output from the computer**

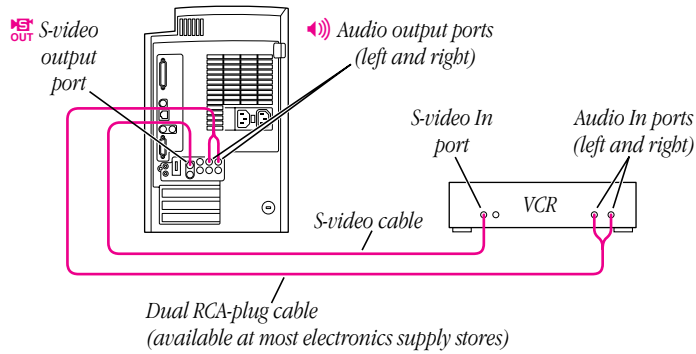

**Composite video connection for output from the computer**

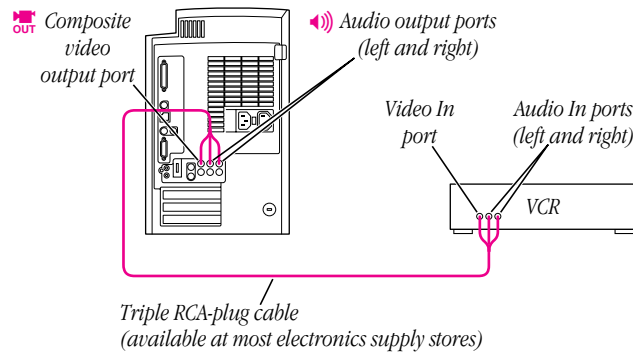

- 6** Turn on the computer and the VCR.
- 7** Select “line input” on your VCR.

See the manual that came with your VCR for instructions on how to select the line input source.

For further instructions on how to record the computer’s output on videotape and add voice annotation, open Mac OS Help (available in the Help menu) and look for the information on saving computer images to videotape in the “monitors” topic area.

## Connecting a Television

You can connect to your computer any television that has either an S-video or composite video input port and Audio In ports. The television displays a mirror image of the computer monitor display, and (if the television has speakers) plays the sounds generated by the computer. This capability is especially useful for giving presentations if you have a large-screen television.

To connect a television for TV mirroring, first you turn off the computer and connect the television to it. Then you use the Control Strip to turn on TV mirroring. (If you need to learn more about the Control Strip, see Mac OS Help, available in the Help menu.)

Because TV mirroring uses a limited number of resolutions supported by televisions, it works best with multisynchronous monitors that support many resolutions. If you are using a fixed-frequency monitor, the monitor display will be disabled when you turn on TV mirroring. (Most newer monitors are multisynchronous; refer to the manual that came with your monitor if you are not sure.)

To connect a television and turn on TV mirroring, do the following:

- 1 Turn off your computer and connect the television according to the instructions in the previous section, “Connecting Video Equipment for Output From the Computer.”

Depending on the type of connectors your equipment has (S-video or composite video), your connection should look similar to one of the following illustrations.

### Television used as a monitor with an S-video connection

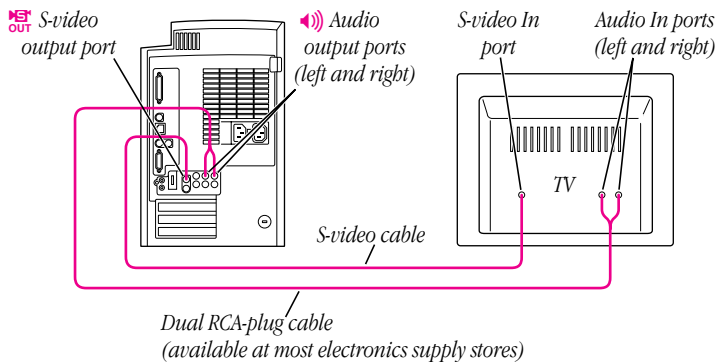

### Television used as a monitor with a composite video connection

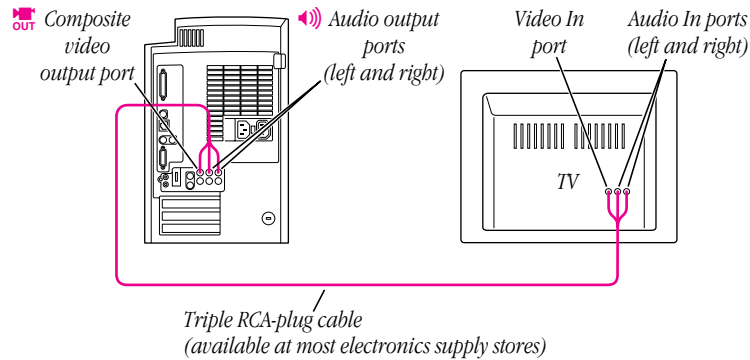

- 2 Turn on the television and the computer.
- 3 Click the TV Mirroring icon in the Control Strip, and choose Turn TV Mirroring On from the menu that appears.

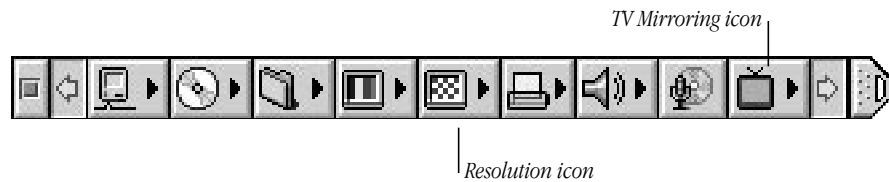

An alert box warns you to make sure a television is connected before continuing.

- 4 Click OK to close the alert box.  
The screen resolution changes to one that is compatible with the television.
- 5 To improve the screen display of the monitor and the television, do one or more of the following:
  - Choose a different resolution from the Resolution icon in the Control Strip.
  - Choose a different Overscan setting from the TV Mirroring icon in the Control Strip.  
When Overscan is turned on, the computer image fills the whole television screen, but the edges may not be visible. Turning off Overscan adds a black border around the computer image so that the entire computer image is visible on the television.
  - Choose the television standard supported by your television (either NTSC or PAL) from the TV Mirroring icon in the Control Strip.
  - Adjust the image controls such as brightness and contrast on the television.
  - To rearrange desktop icons that are no longer on the screen, click anywhere on the Finder desktop and choose Clean Up from the View menu.

To turn off TV Mirroring, click the TV Mirroring icon in the Control Strip, and choose Turn TV Mirroring Off from the menu that appears.

## Connecting External SCSI Devices

Your computer has a port for connecting devices that use the Small Computer System Interface (SCSI, pronounced “skuh-zee”). SCSI is a standard method for connecting disk and cartridge drives, CD-ROM drives, scanners, and other devices. The SCSI port permits high-speed communication between the computer and the device.

The SCSI icon appears above the port on the computer’s back panel.

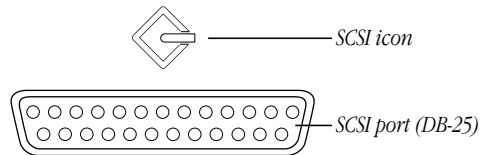

**Note:** An authorized Apple dealer or service provider can also install SCSI devices inside your computer. For more information about the internal SCSI expansion options, see Chapter 3 and the *Technical Information* booklet that came with your computer.

The SCSI interface supports up to seven internal and external SCSI devices.

You can connect external SCSI devices to the SCSI port in a chain. The first device in the chain plugs into the SCSI port; the second device plugs into the first device, and so on.

## Before You Connect a SCSI Device

Before you connect a SCSI device to your Macintosh, follow the instructions in this section.

**Important** This section contains general instructions for attaching SCSI devices to your computer. Also follow the specific instructions that came with your external hard disk drive or other SCSI device when connecting the device to your Macintosh. The specific instructions that came with the device tell how to change a device’s ID number and attach a SCSI cable or terminator to it.

## Make Sure Each Device Has a Unique ID Number

Each external SCSI device connected to your computer must have its own unique ID number from 0 to 6. The SCSI ID number helps the computer keep track of the devices when several devices in the SCSI chain are communicating with the computer simultaneously.

The SCSI devices can be in any physical order in the chain; it is not necessary to arrange them in numerical order.



See the instructions that came with each SCSI device for information on checking and setting its SCSI ID number.

**Important** If you use two or more devices attached to the SCSI interface with the same ID number, your computer will not start up properly, your equipment may malfunction, and you may lose data as a result.

### Use the Right Type and Length of Cable

To attach a SCSI device to your computer or to another device in the chain, always use SCSI cables that are double-shielded, such as Apple SCSI cables. Never use printer-type RS-232 cables (commonly used with DOS and Windows computers).

Poor-quality SCSI cables are often the cause of SCSI problems. Avoid mixing brands and types of SCSI cables.

If the device is the first or only one you're connecting, use a SCSI system cable to connect it to the computer's SCSI port. If the device is not the first one, use a SCSI peripheral interface cable to connect it to the last device in the chain.

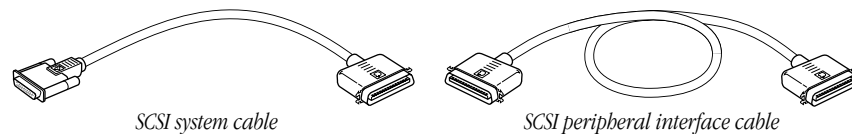

Keep the cables between SCSI devices as short as possible. Cables 18 to 24 inches long are best. PowerBooks and some SCSI devices (particularly scanners) may not be able to handle cables longer than 24 inches.

**Important** The total length of the cables in a SCSI chain should not exceed 6 meters (about 20 feet). SCSI cables must have a 110-ohm impedance. For best results, use SCSI cables manufactured by Apple Computer.

### Terminate the SCSI Chain Properly

To ensure accurate transmission of information, a terminator must be present at each end of a SCSI chain. When you connect external SCSI devices, make sure that only the last external device in the chain has a terminator. (The second terminator at the beginning of the SCSI chain is inside your computer.)

**Important** In almost all cases, only the first and last devices in the SCSI chain should be terminated, with one exception noted later in this section. Make sure that no external SCSI device but the last one has a terminator.

To terminate the last device in the chain, do one of the following:

- Use a device that has a built-in terminator as the last device in the chain.  
If you wish to attach two or more SCSI devices that have built-in terminators, an Apple-authorized service provider can remove the extra built-in terminators.
- If the device at the end of the SCSI chain does not have a built-in terminator, attach an external terminator. You can attach or remove external terminators yourself. (Do not use a black terminator; the black terminators are for Macintosh IIx computers and certain LaserWriter printers only.) Terminators are available at authorized Apple dealers.

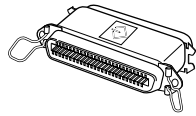

*External SCSI terminator*

**Important** Do not attach a terminator to a device that already has a built-in terminator. If you do, your computer may not start up properly.

*Exception to the “first and last” rule:* If the total cable length in the chain is greater than 10 feet, the chain may need a third terminator at the 10-foot point. Do not add the third terminator unless you are experiencing a SCSI problem, and check all other possible causes of the problem before adding the third terminator.

### Connecting a SCSI Device

After you read “Before You Connect a SCSI Device” earlier in this chapter, follow the instructions below. Use these general instructions in conjunction with the more specific instructions that came with your SCSI device.

- 1 Shut down your Macintosh and make sure the SCSI device is switched off.

**Warning** Do not connect or disconnect any device while the device or your Macintosh is turned on. Doing so could damage the device, your computer, or both. Do not attach or remove a terminator while the computer or any device is turned on.

- 2 Use a SCSI cable to connect the device either to the computer’s SCSI port or to the last SCSI device already in the chain.

Use the thumbscrews and metal clips on the connectors to make a tight, reliable connection. Do not overtighten the thumbscrews.

- 3 Turn on all devices in your SCSI chain. Then turn on your computer.

**Important** Always turn on all external SCSI devices connected to your Macintosh before turning on the computer itself. Otherwise, your computer won't recognize that the SCSI devices are connected to it and your computer may not be able to start up.

- 4 Install any necessary device drivers (software that makes a device work with your computer).

Drivers needed for a SCSI device usually come on a floppy disk with the device. (If no drivers come with the device, contact the device's manufacturer.) Some older SCSI devices may require updated drivers to work with your computer.

**Note:** If you experience problems after connecting a SCSI device, see the troubleshooting information in the *Emergency Handbook* for possible solutions.

## Connecting a Printer

Your computer has a printer port, which you use to connect a printer.

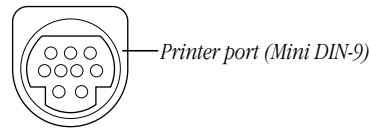
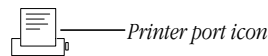

The printer port accepts either a direct cable connection (to printers such as most StyleWriter models) or a network cable connection (to printers such as most LaserWriter models). A printer can also be connected to the modem port.

See the manual that came with your printer for more detailed information and instructions on setting up and using the printer. Your computer comes with most Apple printer software (called "printer drivers") already installed. If you are using a printer from a manufacturer other than Apple, you may need to install a printer driver for the printer to work properly.

You use the Chooser to tell the computer which port you used to connect your printer. For instructions on choosing a printer, open Mac OS Help (available in the Help menu) and look up "printing" in the index.

## Connecting a Second Monitor

You can install an expansion card that provides a second monitor port, if one monitor doesn't provide enough screen space.

To connect a second monitor, purchase a video card and install it in one of the computer's PCI expansion slots, or have an Apple dealer install it for you. (If you are installing the expansion card yourself, follow the instructions that came with the card and the instructions in Chapter 3.) Then connect the second monitor to the port provided by the card.

Make sure that the ventilation openings on the monitors are clear and unobstructed. If there is interference on your screens or on a television or radio near your computer, separate or reposition the affected equipment. You may need to move the monitors farther apart so that they don't interfere with each other.

For additional instructions on using two monitors together, open Mac OS Help (available in the Help menu) after you have connected both monitors to your computer; click the Index button, and choose "monitors" from the index.

## Connecting an ADB Input Device

Your computer has an Apple Desktop Bus (ADB) port, which connects the mouse and the keyboard to your computer. You can add other input devices, such as a bar-code reader, graphics tablet, or joystick.

The ADB port is marked with the  icon. You can connect up to three ADB devices in a chain to a single ADB port. The exact number depends on how much power the devices require.

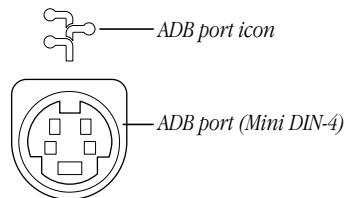

Before you attach or remove an ADB device, turn off the computer. Attaching or removing an ADB device while the computer is turned on could damage the ADB device or your computer.

**Important** The total current used by all ADB devices connected to your computer must not exceed 500 milliamperes (mA). Before attaching another ADB device, check the *Technical Information* booklet that came with your computer and the information that came with the ADB device for power requirements.

## Connecting to a Local Area Network

Connecting to a local area network extends the features of your Macintosh by giving you access to the services and resources provided on the network. For example, your computer alone lets you store, retrieve, and modify information on floppy disks, hard disks, and CD-ROM discs. On a network, however, you can also store and retrieve information on the hard disks and CD-ROM discs of other computers, access information that other people have stored for you, use electronic mail, share resources such as printers and modems or other network services, and access the Internet, if the network has a link to it. (Access to the Internet over a network may be noticeably faster than access with a modem.)

You can get information about the network you want to connect to from the specialist—referred to as the “network administrator”—who oversees its operation. Before you begin, identify your network administrator.

Your computer can be connected to several kinds of networks, including the following:

- *LocalTalk*: To connect to a LocalTalk network, you connect a LocalTalk cable to the printer port on your computer.
- *Ethernet*: To connect to a high-speed Ethernet network, you connect an Ethernet cable to the Ethernet port on the back of the computer or to a port provided by a PCI-based Ethernet card that you install in the computer.
- *Alternative networks such as 100Base-T, ISDN, or Fiber Distributed Data Interface (FDDI)*: To connect to any of these networks, you need a PCI card in one of the PCI slots in your computer. For instructions on installing PCI cards, see Chapter 3.

This section describes the process for connecting your computer to LocalTalk and Ethernet networks.

- If your computer is already connected to a network, see Mac OS Help for information about printing on a networked printer, accessing information on file servers, and sharing files on your computer with other users. Ask your network administrator for information about network software for services such as Internet access and electronic mail.
- If you want to set up a network at your location, a book on Macintosh networking will help you select and plan a network appropriate for your organization. Many books are available, such as *Planning and Managing AppleTalk Networks*, an Apple book published by Addison-Wesley and available at computer bookstores.

## Connecting to a LocalTalk Network

To connect your Macintosh to a LocalTalk network, you need LocalTalk cables and a LocalTalk adapter. In most cases, the Apple LocalTalk Locking Connector Kit DIN-8, available from your Apple-authorized dealer, contains the components you need to connect your Macintosh to an existing LocalTalk network. If your network uses standard telephone cables for your network wiring, obtain an Apple LocalTalk RJ-11 adapter and standard telephone cable instead.

### Apple LocalTalk Locking Connector Kit DIN-8

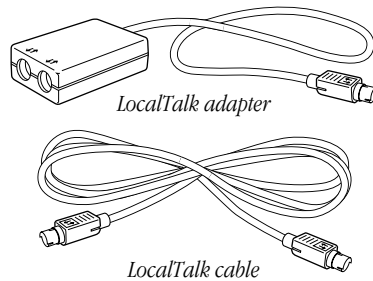

### Apple LocalTalk RJ-11 Adapter

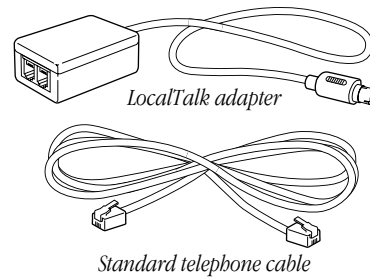

If a network administrator is responsible for network maintenance and upkeep at your location, ask for help connecting your computer to the network.

To connect your Macintosh to a LocalTalk network, do the following:

- 1 Shut down your Macintosh.
- 2 Attach the LocalTalk adapter to the printer port.

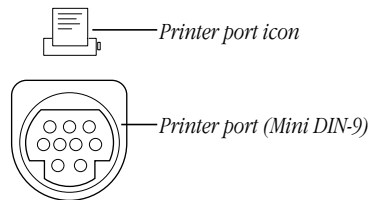

If another device is already connected to the printer port, you can connect the LocalTalk adapter to the modem port.

- 3 Attach a network cable between the LocalTalk adapter connected to your computer and the last LocalTalk adapter on your existing network.

Use the LocalTalk cable that comes with the Apple LocalTalk Locking Connector Kit DIN-8. Use a standard telephone cable with RJ-11 connectors if you are using the Apple LocalTalk RJ-11 Connector Kit.

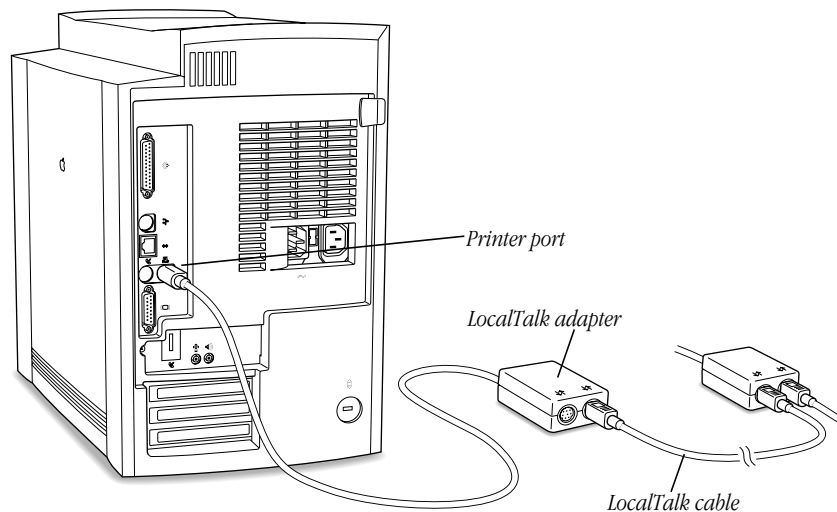

- 4 If you are using a LocalTalk adapter with RJ-11 (telephone) connectors, connect a terminator to the unused RJ-11 connector on the LocalTalk adapter.

For more information on terminators, see the instructions that came with the Apple LocalTalk RJ-11 Connector Kit.

**Note:** A LocalTalk adapter with DIN-8 connectors doesn't require an external terminator.

Next, see "Configuring Your Network Connection" later in this chapter for information on configuring your LocalTalk connection.

## Connecting to a 10Base-T Ethernet Network

The built-in Ethernet capabilities of your Macintosh allow you to connect to any standard Ethernet network using 10Base-T twisted-pair cables, thin or thick coaxial cables, fiberoptic media, or other standard Ethernet cables.

You can connect directly to an Ethernet network that uses 10Base-T twisted-pair cable. To connect your Macintosh to an Ethernet network that uses coaxial cables, you need an RJ-45 to Thin Coax repeater. The repeater is available from manufacturers other than Apple.

See your Apple-authorized dealer for more information on Apple Ethernet media adapters. Also see the following instructions to learn which items to purchase.

**Warning** Do not connect cables to the back of your computer when the computer is on or you may damage your system.

If a network administrator is responsible for network maintenance and upkeep at your location, ask for help connecting your computer to the network.

Follow this procedure to connect your Macintosh to an Ethernet network that uses twisted-pair cable. The hardware connection requires a twisted-pair patch cord with an RJ-45 connector, which looks like a wide version of a standard telephone connector. Take care to use the correct patch cord. You plug the patch cord into a standard wall plate that is connected to a centralized 10Base-T hub.

To connect your Macintosh to a twisted-pair network:

- 1 Shut down your Macintosh.
- 2 Plug one end of the RJ-45 twisted-pair patch cord into the 10Base-T Ethernet port on your Macintosh.

The Ethernet port on the back of your Macintosh is marked with the Ethernet icon:

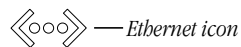



- 3 Plug the other end of the twisted-pair patch cord into an RJ-45 wall outlet that is connected to a twisted-pair Ethernet network.

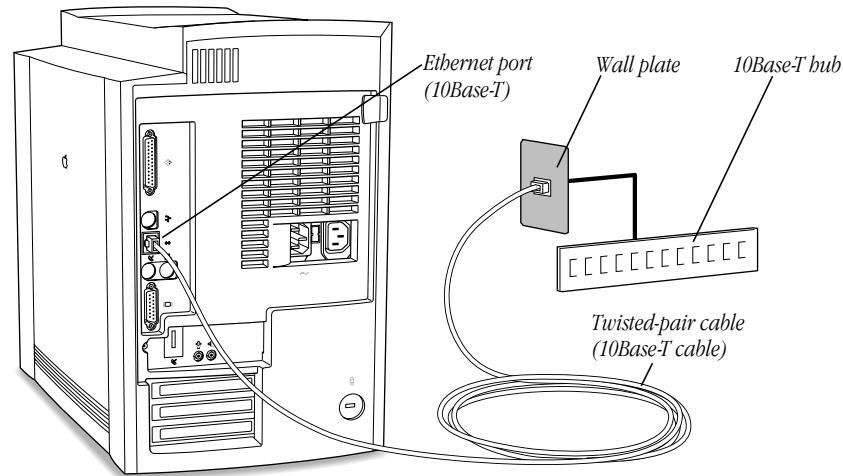

Next, see “Configuring Your Network Connection” later in this chapter for information on configuring your network connection.

### Connecting to Multiple Networks Simultaneously

Because your Macintosh has two networking ports—LocalTalk and 10Base-T Ethernet—it is possible to be physically connected to more than one kind of network at the same time. However, you can use only one of your connections at a time.

If you are connected to both a LocalTalk and an Ethernet network (either 10Base-T or PCI-based), your computer uses the Ethernet connection unless you specify LocalTalk in the AppleTalk control panel. For help in setting up the AppleTalk control panel and specifying the port you want to use, see Mac OS Help, available in the Help menu.

### Configuring Your Network Connection

After you physically connect your computer to a LocalTalk or Ethernet network, you need to configure the software for your network connection in either the AppleTalk control panel, the TCP/IP control panel, or both.

You use the AppleTalk control panel to set up your connection to an AppleTalk network (that is, a network using the AppleTalk protocol).

You use the TCP/IP control panel to set up your connection to the Internet and to a TCP/IP network. TCP/IP stands for *Transmission Control Protocol/Internet Protocol*, a standard system for connections between computers of different types.

You may need additional information about the network to which your computer is connected, or about the service through which your computer is connected to the Internet. To get this information, you may need to contact your network administrator or your Internet service provider.

For help with setting up and using your AppleTalk and TCP/IP control panels, see Mac OS Help.

## Securing Your Computer

To deter theft of your computer and the components inside it, you can purchase a locking cable and attach it to your computer. The back panel has a built-in port for a locking cable, and the computer cover has a lockable latch that prevents the computer from being opened.

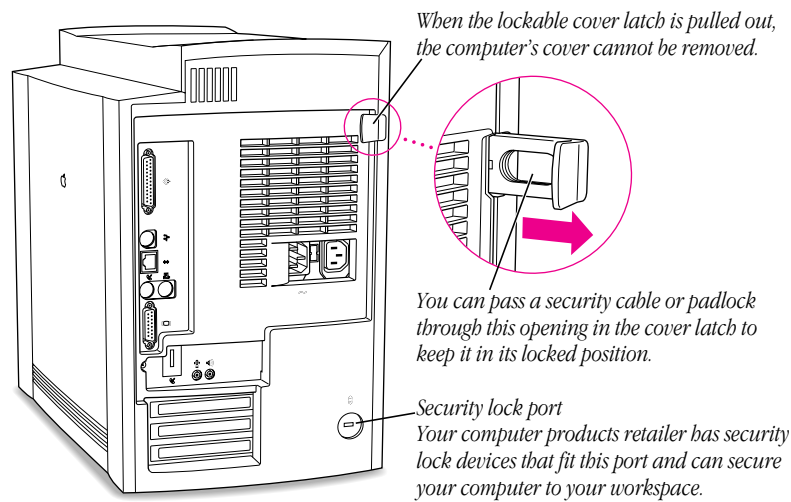

Follow the instructions supplied with the locking cable to secure it to your computer. When you install the locking cable, be sure to thread the cable through the lockable latch on the cover; this locks the computer cover and prevents memory, disk drives, and expansion cards from being removed.

## Installing PCI Cards, Memory, and Internal Storage Devices

This chapter provides information about peripheral component interconnect (PCI) expansion cards, memory, and internal storage devices, and explains how to install them.

Installing these items involves three procedures (detailed steps for each are provided later in this chapter):

- opening the computer
- inserting the card, memory module, or storage device into a specific slot or expansion bay
- closing the computer

**Warning** Apple Computer recommends that you have an Apple-certified technician install memory, PCI expansion cards, and internal storage devices. Consult the service and support information that came with your computer for instructions on how to contact an Apple-authorized service provider or Apple for service. If you install these items yourself, you risk damaging your equipment, and this damage is not covered by the limited warranty on your computer. See an Apple-authorized dealer or service provider for additional information about this or any other warranty question.

### About PCI Expansion Cards

You can install printed circuit boards (called “cards”) for video and graphics applications, networking and communications, additional processing power, or other purposes. The cards fit into connectors, called “expansion slots,” inside the computer.

Your Macintosh has three expansion slots, each designed to accept a 7-inch or 12-inch long PCI card. Install only expansion cards that come with Macintosh drivers and are compliant with the PCI 2.1 standard. NuBus™ cards cannot be used in these expansion slots.

## Expansion Card Power Requirements

The combined power consumption of expansion cards must not exceed the limits specified for your Macintosh model. For details, see the *Technical Information* booklet that came with your computer.

**Warning** To avoid damaging your computer and expansion card, do not attempt to install any expansion card without first checking the documentation for that card. If the documentation specifies that an Apple-certified technician must install the card (usually because the installation requires special training or tools), consult the service and support information that came with your computer for instructions on how to contact an Apple-authorized service provider for assistance. If you attempt to install the card yourself, any damage you may cause to the computer or card will not be covered by the limited warranty on your computer. If the card is not an Apple-labeled product, check with an Apple-authorized dealer or service provider to see if you can install it yourself.

## About Memory

You can add memory—dynamic random-access memory (DRAM) or video memory—to your computer in packages called Dual Inline Memory Modules, or DIMMs.

The following illustration shows the locations of memory slots on the logic board. See the sections that follow for important information about DRAM and video memory.

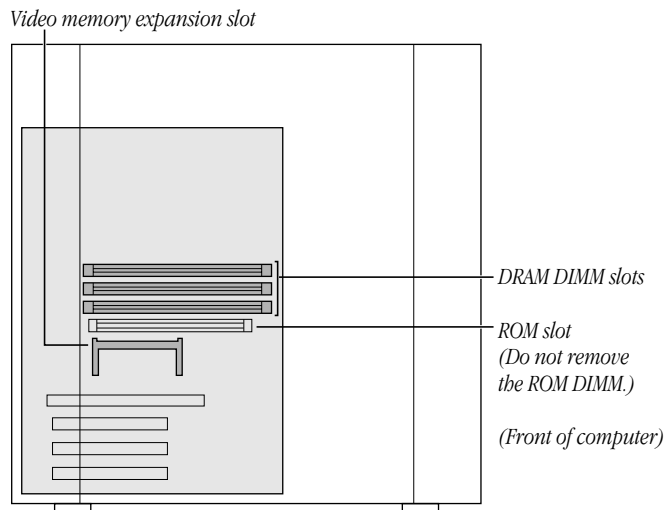

**Important** Do not remove the module installed in the ROM slot.

## DRAM Configurations

You can increase your computer's DRAM up to 384 megabytes (MB) by adding Dual Inline Memory Modules (DIMMs) to the three DRAM DIMM slots on the main logic board. See the *Technical Information* booklet that came with your computer for information about the type of DIMMs you must use.

**Important** This computer uses Synchronous Dynamic Random-Access Memory (SDRAM) DIMMs. DIMMs from older Macintosh computers are not compatible with your computer and should not be used even though they fit into the DRAM DIMM slots.

DIMMs can be installed one at a time in any order in any of the memory slots.

To increase DRAM to the maximum of 384 MB, fill all three slots with 128 MB DIMMs.

## Video Memory Configurations

Your computer comes with 2 MB of video memory built into the logic board and a video memory expansion slot that allows you to expand video memory up to 6 MB. The expansion slot accepts a 2 MB or 4 MB Synchronous Graphic RAM (SGRAM) Small Outline DIMM (SO-DIMM). See the *Technical Information* booklet that came with your computer for information about the type of DIMM you must use. (Your computer may already have an SO-DIMM installed.)

**Important** Use only SGRAM SO-DIMMS.

**Warning** If your computer came with an internal modem, an Apple-certified technician or authorized service provider must install video memory because the modem must be temporarily removed to allow access to the video memory expansion slot. Only an Apple-certified technician or authorized service provider can remove the modem. To avoid damaging your computer, do not attempt to install video memory if your computer came with an internal modem.

## About Internal Storage Options

There are two expansion bays inside your computer for connecting internal storage devices. The expansion bay directly below the CD-ROM drive accepts 5.25-inch (or smaller) ATA or SCSI devices. (Some models come with a Zip drive already installed in this expansion bay.) The bottom expansion bay can accept 5.25-inch (or smaller) SCSI devices. Additional options such as an Ultra Wide SCSI hard disk and PCI card combination can also be installed. See your Apple-authorized dealer for more information.

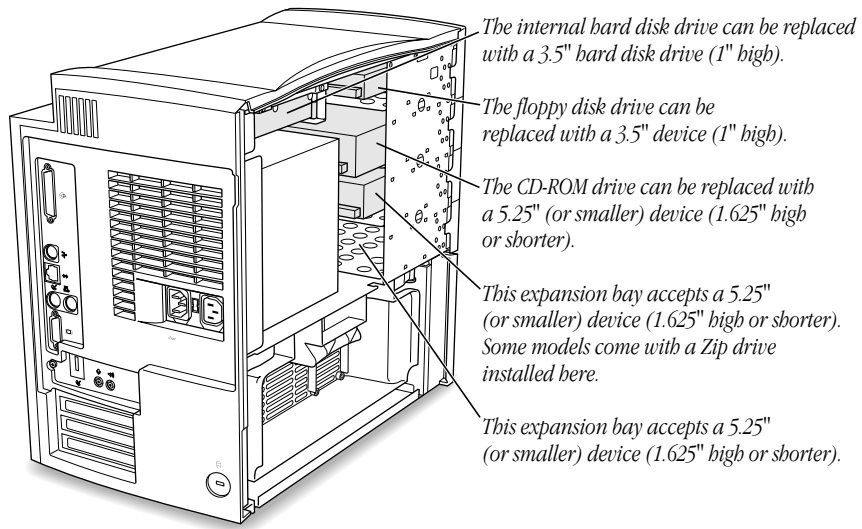

**Important** Hard disk drives and removable storage devices may require special software that the computer uses to recognize the device. Check the documentation that came with your device or contact the device's manufacturer for more information.

### Connecting an Additional ATA Device

If your computer did not come with a Zip drive or other device installed in the expansion bay below the CD-ROM drive, you can install an additional ATA storage device. You connect this second ATA device to the empty 40-pin connector on the end of the ATA ribbon cable that supports the internal CD-ROM drive.

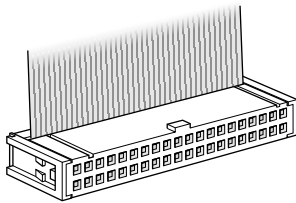

40-pin connector

**Note:** A second ATA device can only be installed in the expansion bay below the CD-ROM drive. If you want to install a storage device in the bottom expansion bay, you need to connect it to the logic board using an internal SCSI cable (not included with your computer) or to another internal device connector such as an Ultra Wide SCSI PCI card from another manufacturer. See your Apple-authorized dealer for more information.

**Important** Before installing a second ATA device, you need to set the device to be the “slave” device. The internal CD-ROM drive in your computer is set to function as the “master” device. See the documentation that came with your storage device for instructions on setting the device designation. (Your computer does not support ATA cable select mode.) If the two devices on the same ATA ribbon cable are set to the same designation, your computer will not function properly.

**Important** If the ATA device that you are installing comes with software to format the device, make sure that the software supports both “master” and “slave” devices. Formatting your device with incompatible software may cause problems during computer startup. See the documentation that came with the device or contact the device’s manufacturer for more information.

### Connecting an Internal SCSI Device

Your Apple-authorized service provider can install an internal SCSI ribbon cable with 50-pin connectors that you can use to connect a SCSI device installed in an empty expansion bay.

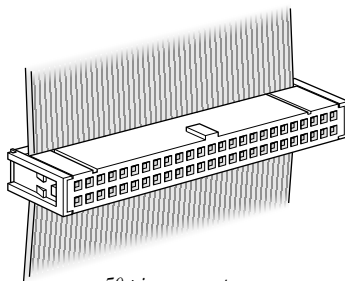

*50-pin connector*

All internal and external devices on the SCSI chain must have unique ID numbers. SCSI ID numbers 0 through 6 are available. (SCSI ID number 7 is reserved for the computer.) Always terminate the last internal and the last external SCSI device.

## Installing a PCI Expansion Card, Memory, or an Internal Storage Device

Follow these instructions to install a PCI expansion card, memory, or an internal storage device.

**Important** Before installing any of these items, carefully read “About PCI Expansion Cards,” “About Memory,” and “About Internal Storage Options” earlier in this chapter.

### Opening the Computer

- 1 If your computer is turned on, turn it off by choosing Shut Down from the Special menu. Then wait 5 minutes.

Before proceeding with these instructions, you need to allow the computer’s internal components to cool.

- 2 Unplug all the cables from the computer, including the power cord.

**Important** If your computer has an internal modem, unplug the phone cord from the modem.

- 3 If the cover is locked shut, unlock it by removing the security cable or padlock from the cover latch.

Do not remove the cover yet.

- 4 If you have never plugged in your computer, make sure the voltage switch is set correctly for the voltage system to which you will be connecting the computer.

If you don’t know the voltage used in the country you’re in, refer to “Voltage Switch Settings for Different Locations,” in Chapter 1, “Setting Up Your Computer.”

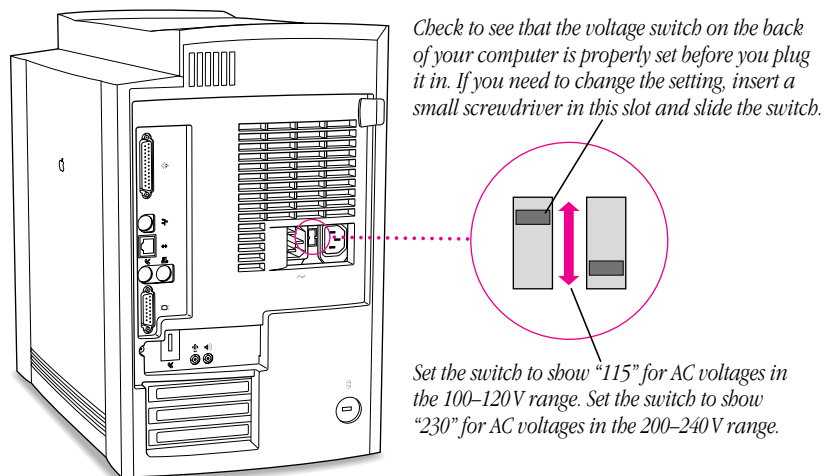



- 5 Carefully lay the computer on its side with the cover and button facing up.

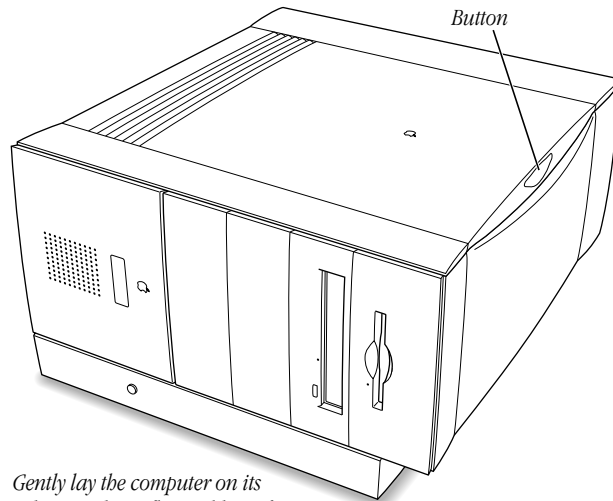

*Gently lay the computer on its side on a clean, flat, stable surface.*

- 6 Reconnect the power cord to the computer.  
Connect the power cord to your computer and to an AC outlet.

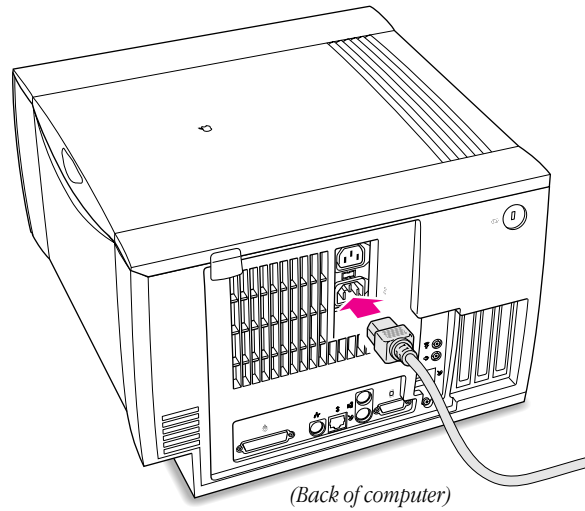

- 7 Touch the metal part of the chassis on the bottom of the computer.

This helps protect the computer from damage caused by electrostatic discharge.

**Important** Always do this before you touch any parts, or install any components, inside the computer. To avoid generating static electricity, do not walk around the room until you have completed the installation of the expansion card, memory, or internal storage device and closed the computer.

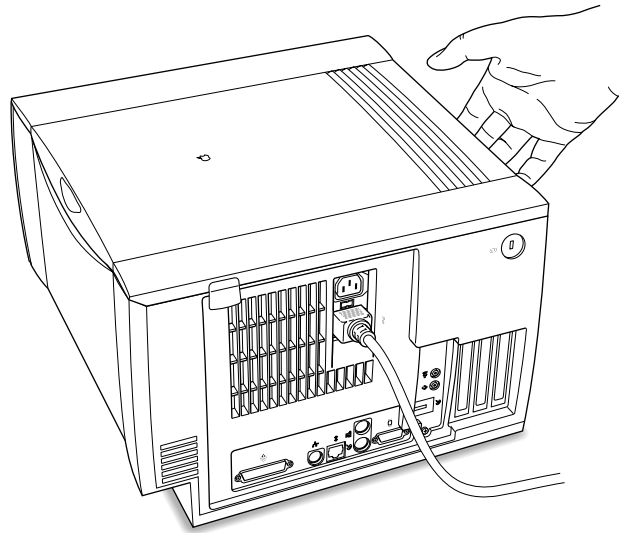

- 8 Disconnect the power cord from the back of the computer.

**9** Remove the cover.

*Press the button and lift the cover panel up a few inches.*

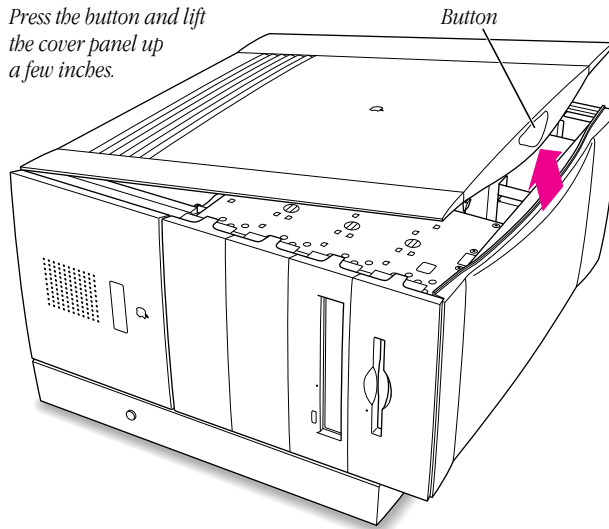

*Slide the cover panel to the right and lift it off.*

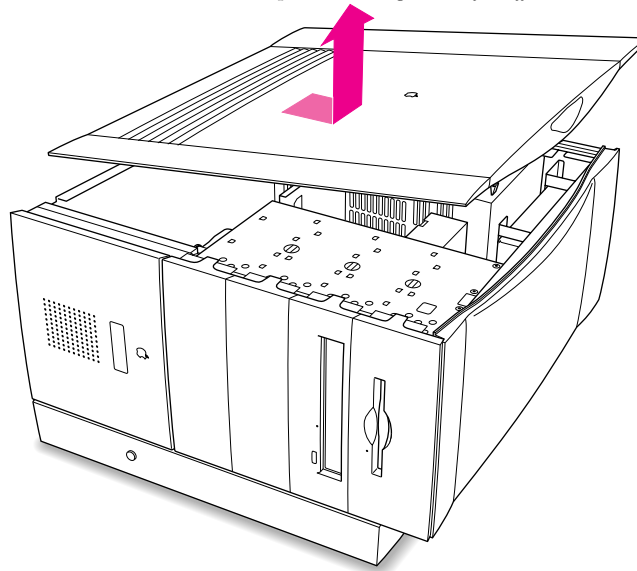

**10** Set the cover panel aside.

To protect the metal shielding on the inside of the cover, lay it down so that the metal shielding faces up.

- 11** If you are installing a PCI card or memory, open the chassis by following the illustrations below. (Skip this step if you are installing an internal storage device such as a hard disk.)

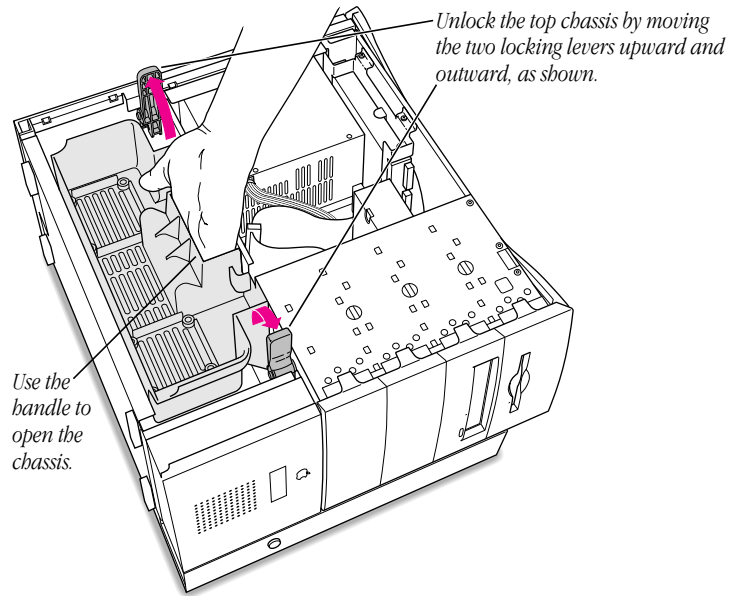

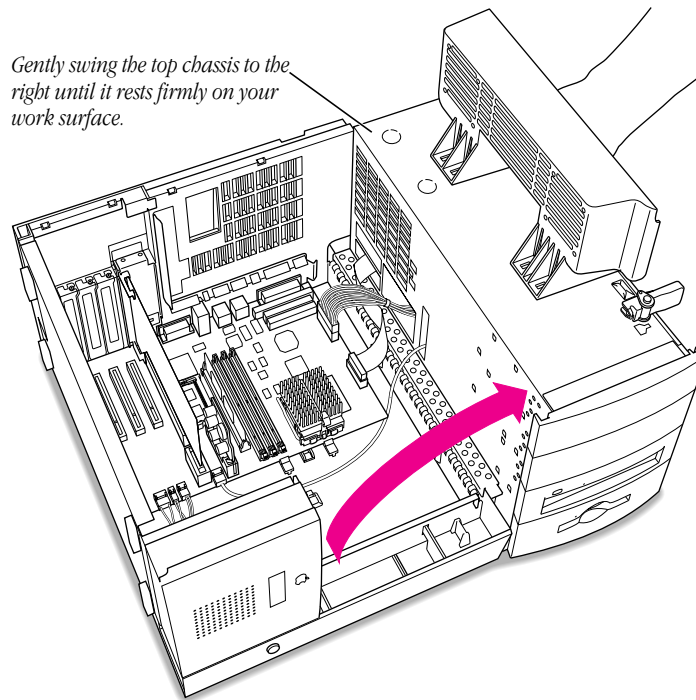

What you do next depends on whether you are installing a PCI expansion card, memory, or an internal storage device.

- 12** Go to the section that provides the instructions for the item that you want to install.

To install	Go to the section
PCI expansion card	“Installing a PCI Expansion Card,” next
Memory	“Installing DRAM or Video Memory” later in this chapter
Internal storage device	“Installing a Hard Disk or Other Storage Device” later in this chapter

### Installing a PCI Expansion Card

**Important** Before installing a PCI expansion card, read “About PCI Expansion Cards” at the beginning of this chapter. Also, follow the steps in “Opening the Computer” to open the computer safely.

- 1 Remove the screw that holds the port access cover in place, pull out the access cover, and set it aside.

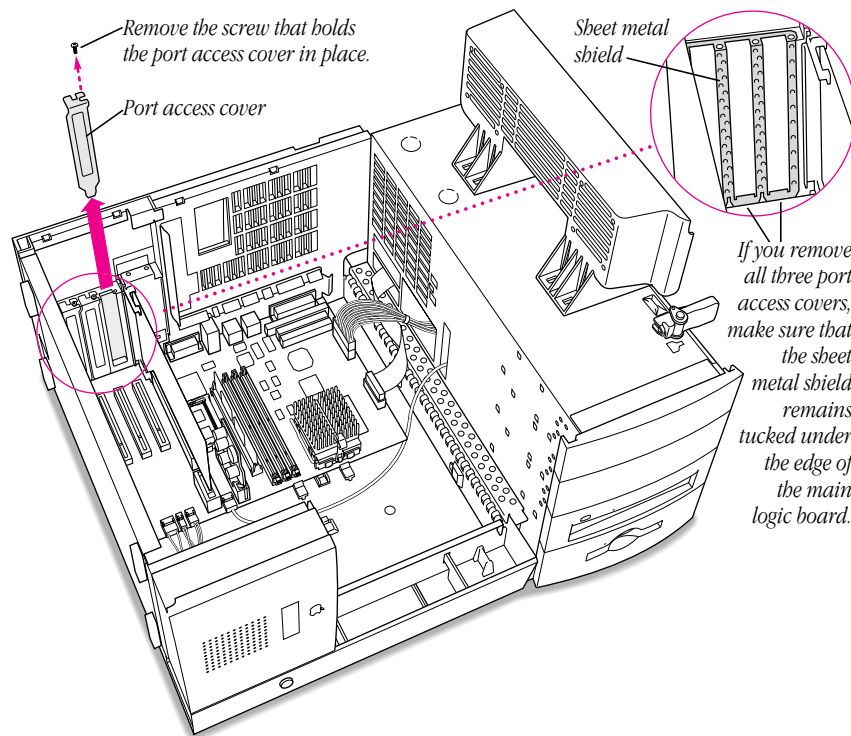

**Important** If you remove all three port access covers, do not disturb the foil shield lying against the back panel. If the shield slips out of the space between the back panel and the main logic board, tuck it back in before you close the computer. Damage could result if the foil touches the logic board while the computer is turned on.

- 2 Remove the PCI card from its static-proof bag and hold it by its corners, taking care not to touch the gold connector or any of the components on the card.

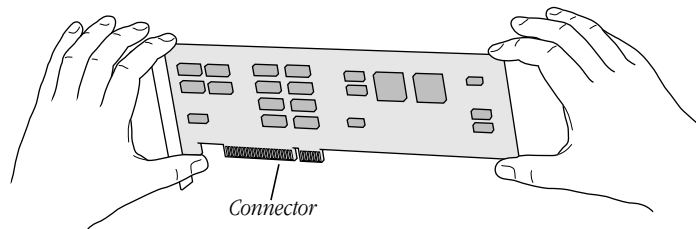

- 3** Align the card's connector with the expansion slot and press down until the connector is inserted all the way into the slot.

Press the card gently but firmly until the connector is fully inserted.

- Don't rock the card side to side; instead, press the card straight into the slot. (Rocking the card can damage the PCI slot.)
- Don't force the card. If you meet a lot of resistance, pull the card out and try again.
- To see if the card is properly connected, pull it gently. If it resists and stays in place, it's connected. (Make sure you don't pull the card so much that you accidentally disconnect it.)

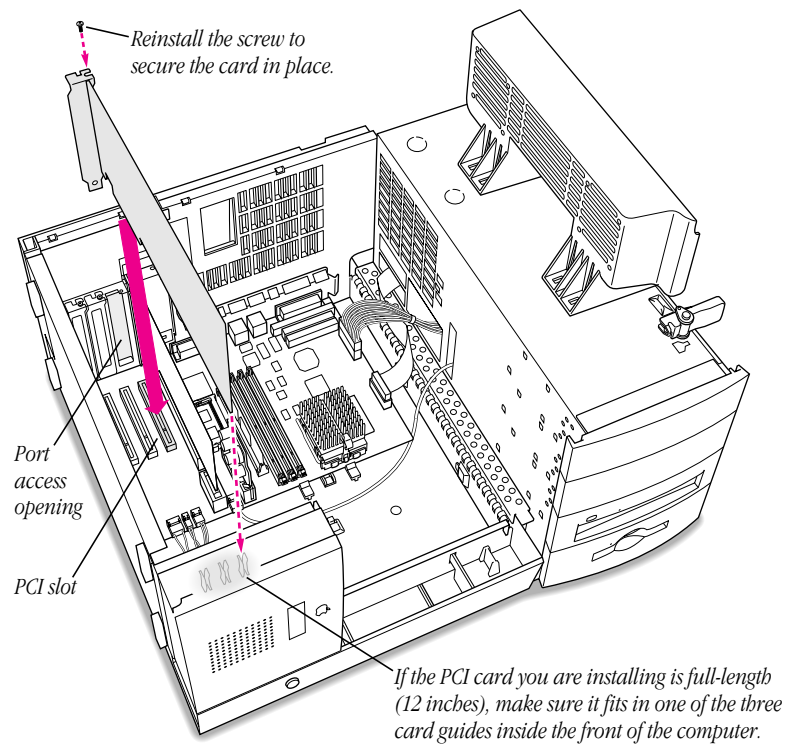

**Note:** In rare cases, some 12-inch PCI cards may be difficult to insert in the slot; the ports on the PCI card fence may stick out so far that it is not possible to install the card. If you have tried several times to insert a card and are still unsuccessful, skip now to “Installing an Unusually Long PCI Card,” next.

- 4** Reinsert the screw that you removed earlier and tighten it to hold the PCI card in place. If you have other cards to install, put them in now by repeating steps 1 through 4.

- 5 If you are finished installing items in your computer, skip ahead to “Closing the Computer” later in this chapter. To install additional items inside your computer, go to the section that provides the instructions you need.

To install	Go to the section
Memory	“Installing DRAM or Video Memory” later in this chapter
Internal storage device	“Installing a Hard Disk or Other Storage Device” later in this chapter

### Installing an Unusually Long PCI Card

If you are having difficulty inserting a 12-inch PCI card into the slot, it may be necessary to temporarily remove the speaker housing/card guide assembly to install the card. Follow these steps to remove the speaker housing/card guide assembly and install a PCI card.

- 1 Remove the speaker housing/card guide assembly as shown below.

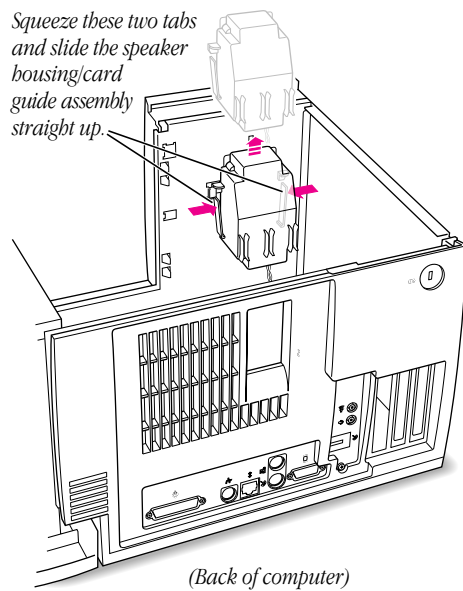

- 2 Move the speaker housing/card guide assembly to one side so that it does not block the slot you want to use.



- 3** Insert the PCI card into the slot. Press the card gently but firmly until the connector is fully inserted.
  - Don't rock the card side to side; instead, press the card straight into the slot. (Rocking the card can damage the PCI slot.)
  - Don't force the card. If you meet a lot of resistance, pull the card out and try again.
  - To see if the card is properly connected, pull it gently. If it resists and stays in place, it's connected. (Make sure you don't pull the card so much that you accidentally disconnect it.)
- 4** Slide the speaker housing/card guide assembly back into place.

*Slide the speaker housing/card guide assembly straight down and snap it back into place inside the computer. Be sure that the proper card guide engages the end of the card as you slide the assembly in place.*

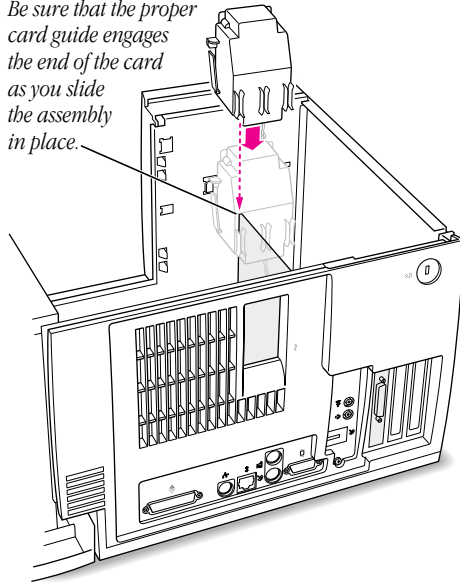

- 5** Reinsert the screw that you removed earlier and tighten it to hold the PCI card in place.
- 6** If you are finished installing items in your computer, skip ahead to “Closing the Computer” later in this chapter. To install additional items inside your computer, go to the section that provides the instructions you need.

To install	Go to the section
Memory	“Installing DRAM or Video Memory,” next
Internal storage device	“Installing a Hard Disk or Other Storage Device” later in this chapter

---

### Installing DRAM or Video Memory

**Important** Before installing memory, read “About Memory” at the beginning of this chapter. Also, follow the steps in “Opening the Computer” to open the computer safely.

**Warning** If you are installing video memory and an internal modem blocks access to the video memory slot, do not remove the modem yourself. Only an Apple-certified technician or authorized service provider can remove the modem. Close the computer by following the instructions in “Closing the Computer” later in this chapter. Then take the computer to an Apple-certified technician or authorized service provider, who can install the video memory for you. To avoid damaging your computer, do not attempt to install video memory if your computer came with an internal modem.

- 1 To install a DRAM DIMM, align it in the DRAM slot as pictured and push the DIMM down until the ejectors snap into place.

**Important** Do not touch the DIMM's connectors. Handle the DIMM only by the edges.

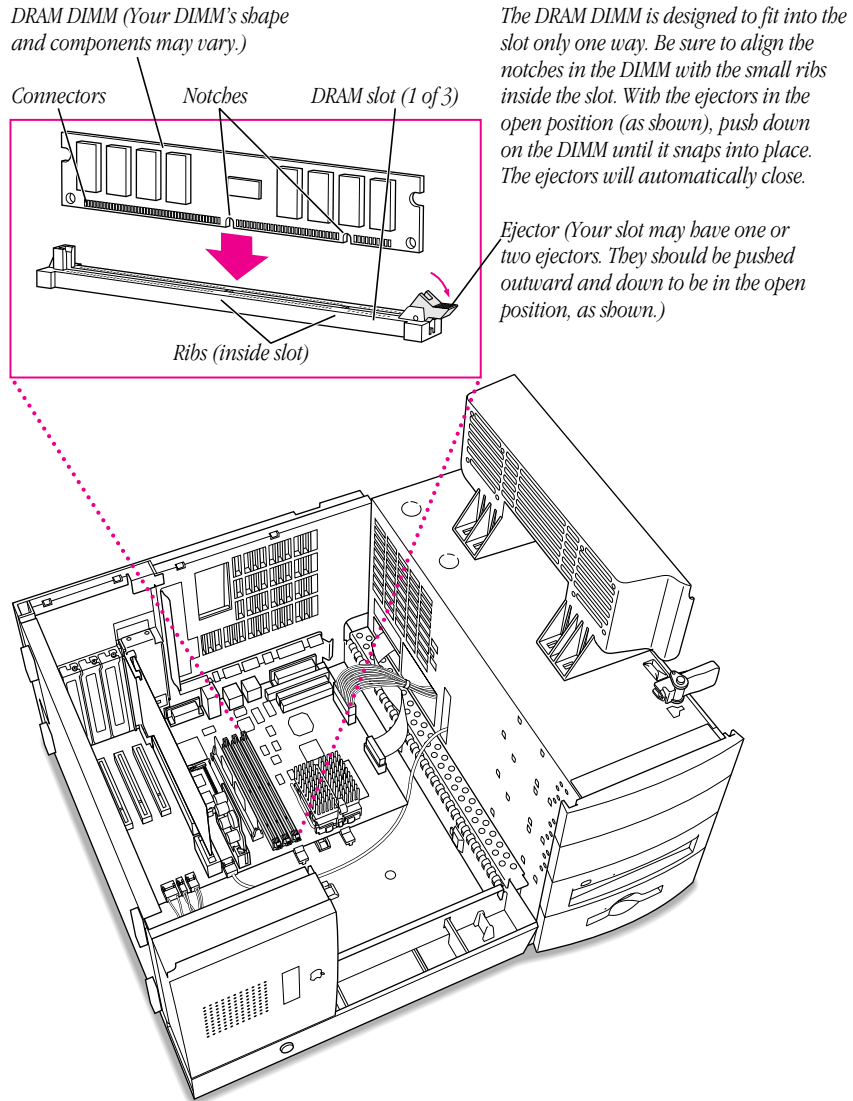

To remove a DIMM, push down on each of the slot's ejectors until they open and release the DIMM.

- 2 To install video memory, place the SO-DIMM in the slot as illustrated.

**Important** Do not touch the SO-DIMM's connectors. Handle the SO-DIMM only by the edges.

SGRAM SO-DIMM (Your DIMM's shape and components may vary.)

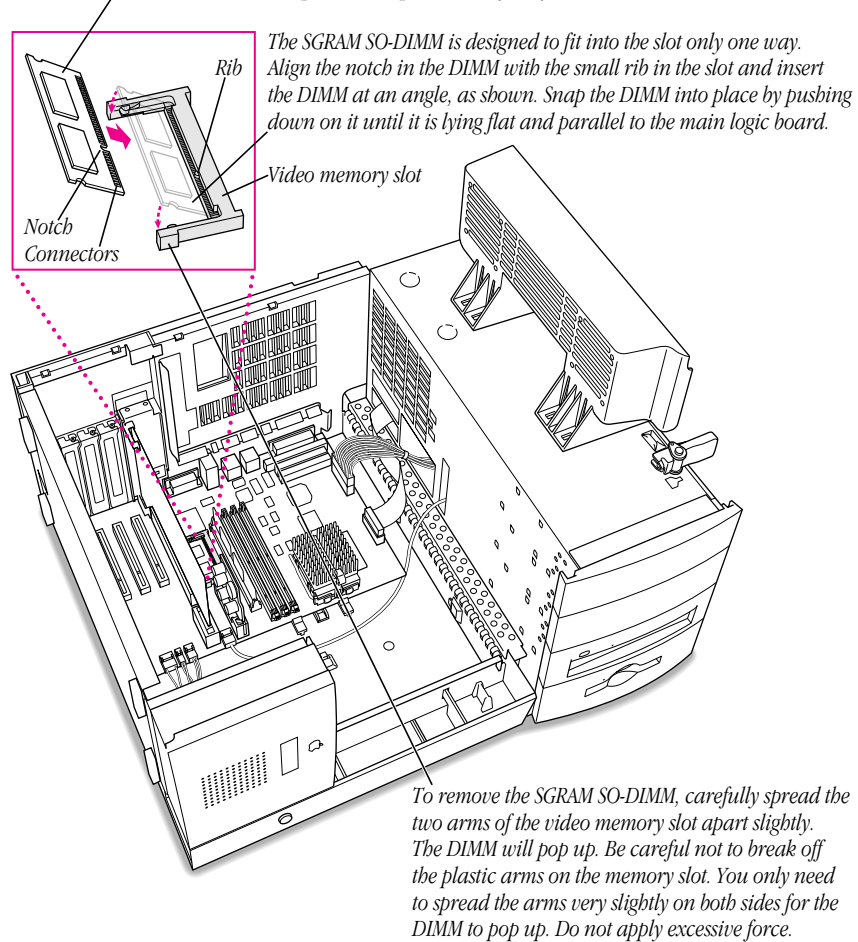

- 3 If you are installing an internal storage device, go to the section, "Installing a Hard Disk or Other Storage Device," next. If you are finished installing items in your computer, proceed to "Closing the Computer" later in this chapter.

## Installing a Hard Disk or Other Storage Device

**Important** Before installing an internal storage device, read “About Internal Storage Options” at the beginning of this chapter. Also, follow the steps in “Opening the Computer” to open the computer safely.

Follow these steps to install a hard disk or other storage device in one of the expansion bays below the floppy disk drive and CD-ROM drive.

- 1 If you just finished installing a PCI expansion card or memory, replace the chassis by swinging it back into place. Then lock the chassis by rotating the locking levers.

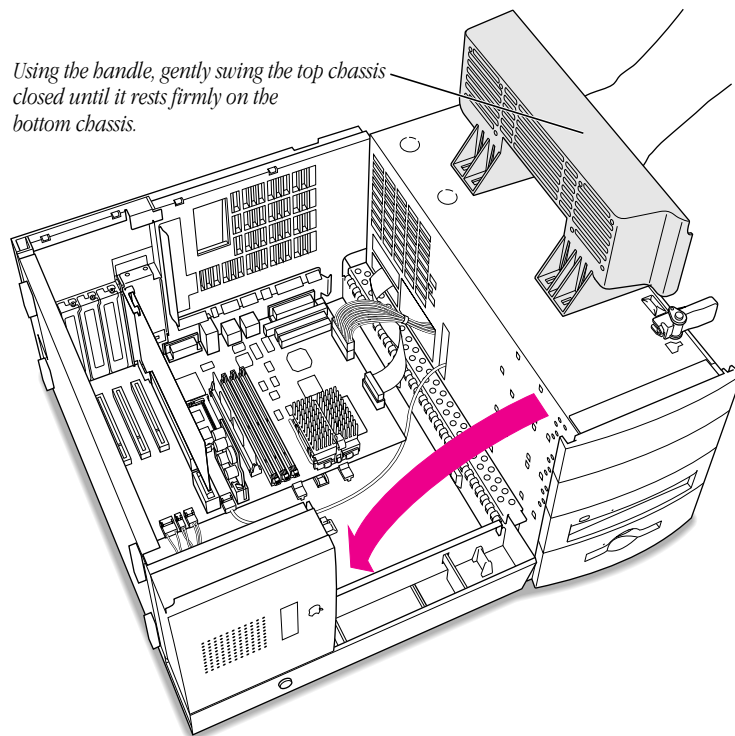

Lock the top chassis in place by moving the two locking levers inward and downward, as shown. Be sure that they snap underneath the raised catches on the chassis.

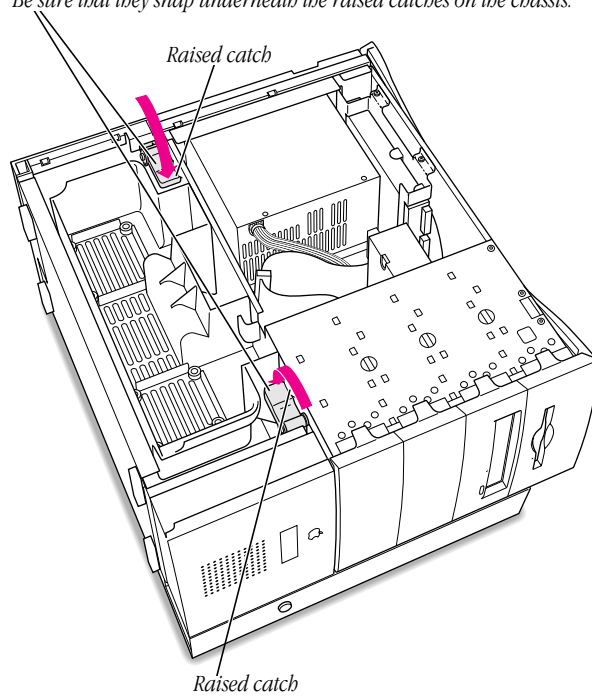

- 2** Carefully lift up the computer so that it sits upright.
- 3** If you are replacing an existing device with a new one, disconnect the ribbon cable and power cord from the device you want to remove.
- 4** Remove the plastic faceplate.

Gently lift this tab to release the plastic faceplate, and remove it completely.

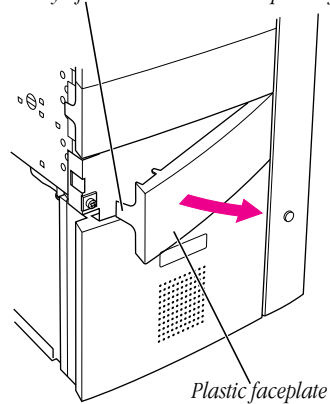

- 5** Remove the two screws from the sheet metal shield. Then carefully remove the shield and slide the drive carrier out of the expansion bay.

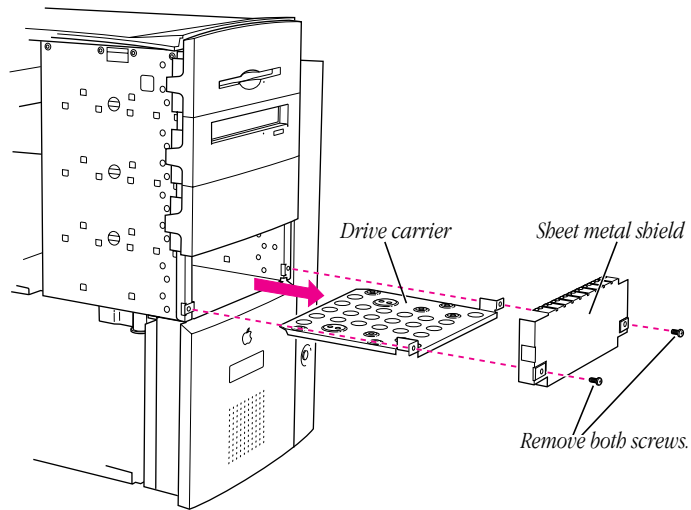

- 6** If you are replacing an existing storage device, remove the existing device from the drive carrier.

- 7** Using screws, attach the storage device to the drive carrier.

Make sure you attach the storage device to the correct side of the drive carrier, as shown in the illustration.

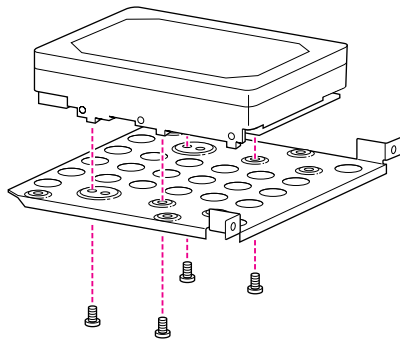

- 8** Slide the drive carrier back into the expansion bay.

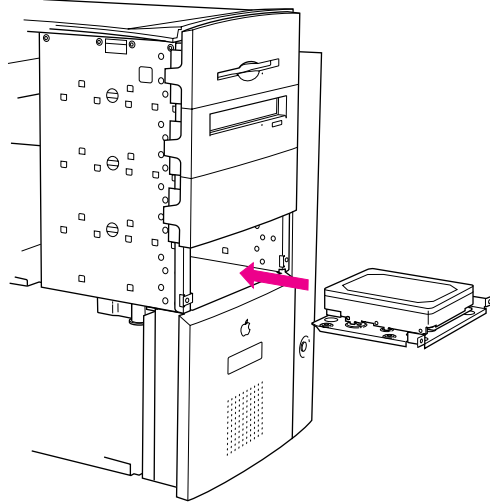

- 9** While holding the drive in place with one hand, connect a power cable and the connector cable to the back of the device.

You can temporarily slide the device slightly forward if you need more room to attach the cables to the back of the device.

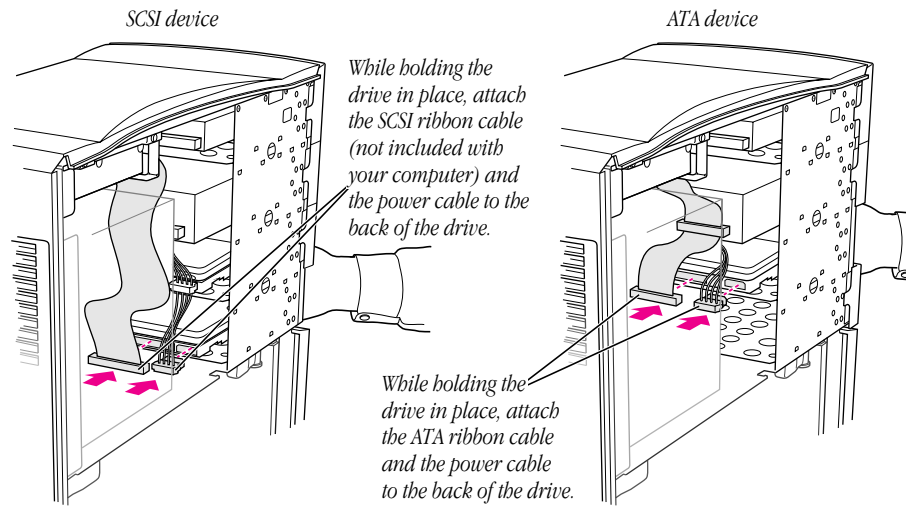



- 10** Replace the sheet metal shield you removed earlier. Then reinsert the screws and tighten them.  
**Note:** Do not replace the sheet metal shield if you're installing a removable storage device such as a tape drive. If a specialized sheet metal shield came with the device, install it instead and replace the screws. Otherwise, insert the screws into the drive carrier and tighten them.

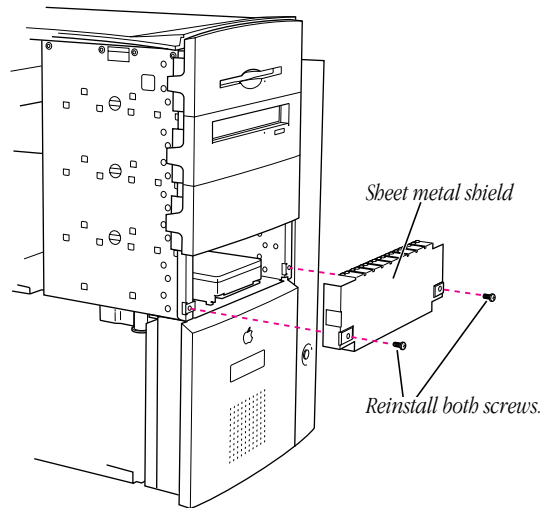

- 11** Replace the plastic faceplate.  
**Note:** If the device is a removable storage device such as a tape or cartridge drive, do not install the faceplate you removed earlier. If a new faceplate is included with the removable storage device, install it instead.

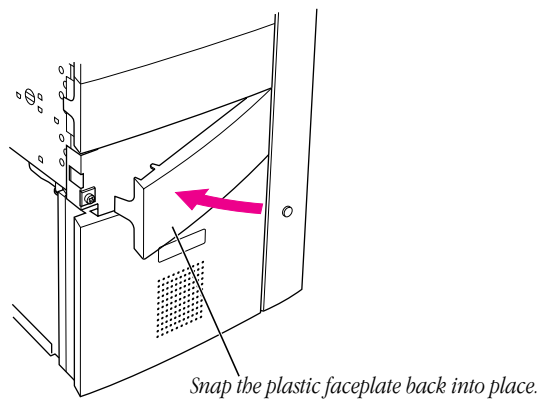

- 12** Carefully lay the computer on its side.  
**13** Proceed to “Closing the Computer,” next.

### Closing the Computer

- 1 If the chassis is open, close the chassis by swinging it back into place.

*Using the handle, gently swing the top chassis closed until it rests firmly on the bottom chassis.*

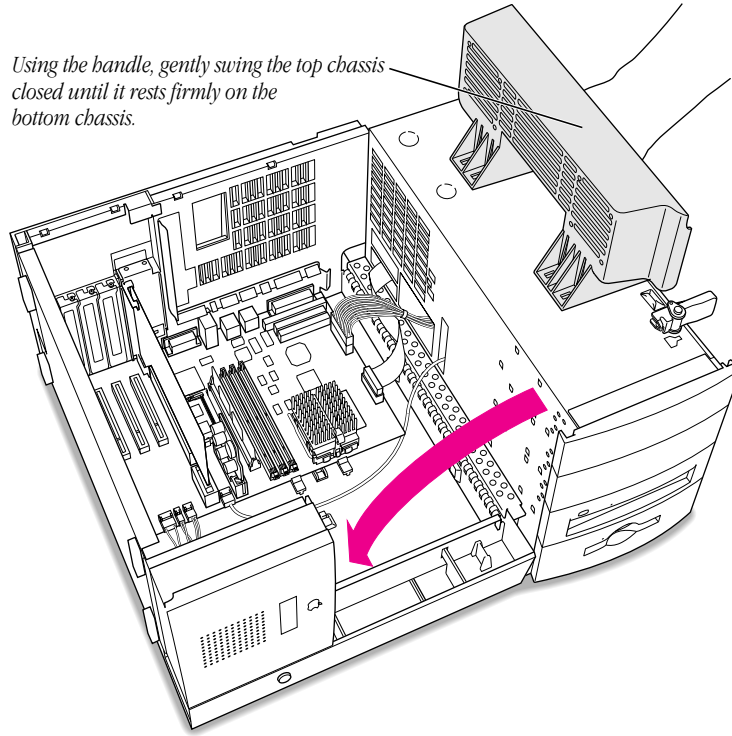

**2** Lock the chassis by rotating the locking levers.

*Lock the top chassis in place by moving the two locking levers inward and downward, as shown. Be sure that they snap underneath the raised catches on the chassis.*

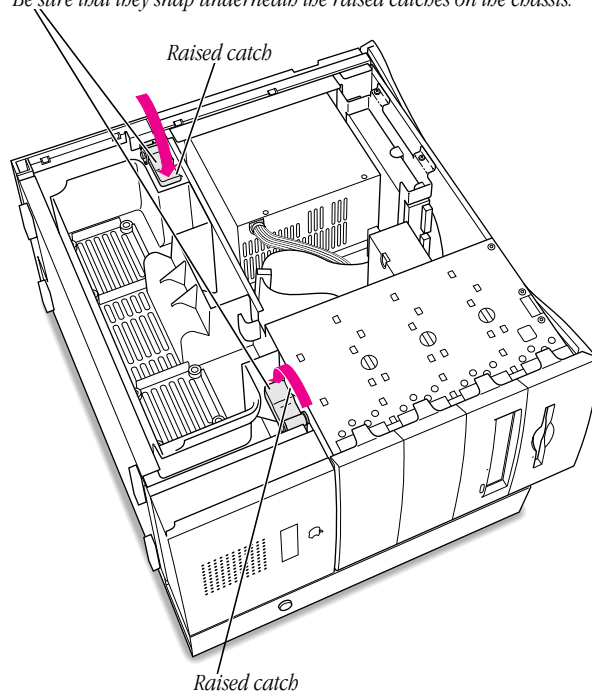

**3** Replace the computer cover panel.

Align the bottom edge of the cover panel with the computer chassis as shown below. Then press the cover panel onto the chassis until it snaps into place.

*Fit the bottom edge of the cover panel into the floor of the computer.*

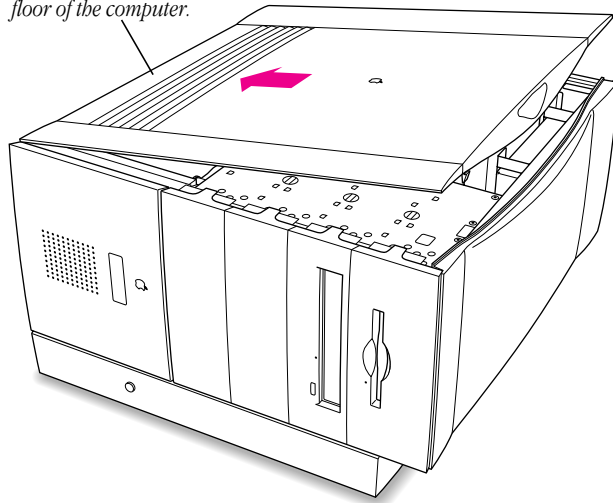

*Press down on the top edge of the cover panel until it snaps firmly into place.*

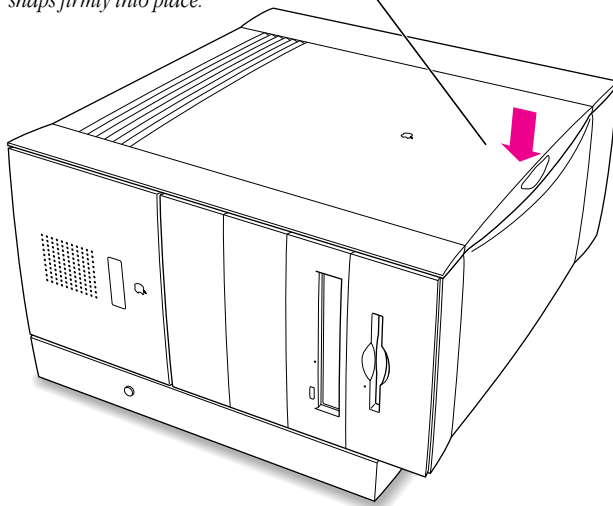

- 4 Lift up the computer so that it sits upright.

You are now finished with the installation. You can reconnect the cables and power cord you disconnected from your computer, turn on the computer, and start using the equipment you installed.

If you need help reconnecting your cables, see Chapter 1, “Setting Up Your Computer.”

**Warning** Never turn on your computer unless all of its internal and external parts are in place. Operating the computer when it is open or missing parts can be dangerous and damage your computer.

### What's Next?

Before you can start using the equipment you installed, you may have to install software that the equipment requires or configure the equipment. For example, PCI expansion cards usually require special software, and hard disks may need to be initialized with a disk-formatting utility. See the manuals that come with the equipment for additional installation or configuration instructions.

**Note:** Some older devices may require updated drivers to work with your computer. (A “driver” is special software that is installed in your System Folder.) Contact the device’s manufacturer for information on obtaining driver software.



## Health, Safety, and Maintenance Tips

For your own safety and that of your equipment, follow all the instructions in this chapter. Keep these instructions available for reference by you and others.

### Health-Related Information About Computer Use

Muscle soreness, eye fatigue, and other discomforts and injuries sometimes associated with using computers can occur from performing any number of activities. In fact, misuse of the same muscles during multiple activities can create a problem that might not otherwise exist. For example, if you engage in nonwork activities that involve repetitive wrist motions—such as bicycling—and also use your computer’s keyboard improperly, you may increase your likelihood of developing wrist problems. Some research indicates that certain individuals are at greater risk of developing these problems because of their health, physiology, lifestyle, and general exposure to stress.

Work organization and conditions, such as workstation setup and lighting, also play a part in your overall health and comfort. Preventing health problems is a multifaceted task that requires careful attention to the way you use your body every hour of every day.

The most common health effects associated with using a computer are musculoskeletal discomfort and eye fatigue. We’ll discuss each area of concern in this appendix.

### Musculoskeletal Discomfort

As with any activity that involves sitting for long periods of time, using a computer can contribute to making your muscles sore and stiff. To minimize these effects, set up your work environment carefully, using the guidelines that follow, and take frequent breaks to rest tired muscles. To make working with your computer more comfortable, allow enough space in your work area so that you can change position frequently and maintain a relaxed posture.

Another type of musculoskeletal concern is so-called repetitive stress injuries (RSIs), also known as cumulative trauma disorders (CTDs). These problems can occur when a certain muscle or tendon is repeatedly overused and forced into an unnatural position. The exact causes of RSIs are not totally understood, but in addition to awkward posture, such factors as the amount of repetition, the force used in the activity, the individual's physiology, workplace stress level, and lifestyle may affect the likelihood of developing an RSI.

RSIs did not suddenly arise when computers were invented; tennis elbow and writer's cramp, for example, are two RSIs that have been with us for a long time. Although less common than other RSIs, one serious RSI discussed more often today is a wrist problem called carpal tunnel syndrome, which may be aggravated by improper use of computer keyboards. This nerve disorder results from excessive pressure on the median nerve as it passes through the wrist to the hand.

This section offers advice on setting up your work area to enhance your comfort while you use your computer. Since the effects of repetitive movements associated with using a computer can be compounded by those of other work and leisure activities to produce or aggravate physical problems, proper use of your computer system must be considered as just one element of a healthy lifestyle.

No one, of course, can guarantee that you won't have problems even when you follow the most expert advice on using computer equipment. You should always check with a qualified health specialist if muscle, joint, or eye discomfort or problems occur.

### **Eye Fatigue**

Eye fatigue can occur whenever the eyes are focused on a nearby object for a long time. This problem occurs because the eye muscles must work harder to view an object that's closer than about 20 feet (6 meters). Improper lighting can hasten the development of eye fatigue. Although eye fatigue is annoying, there's no evidence that it leads to permanent damage.

Whenever you're engaged in an activity that involves close-up work—such as reading a magazine, doing craft work, or using a computer—be sure to have sufficient glare-free lighting and give your eyes frequent rest breaks by looking up and focusing on distant objects. Remember to have your eyes examined regularly.

To prevent discomfort and eye fatigue:

- Arrange your work space so that the furniture is properly adjusted for you and doesn't contribute to an awkward working posture.
- Take frequent short breaks to give your muscles and eyes a chance to rest.



## Arranging Your Office

Here are some guidelines for adjusting the furniture in your office to accommodate your physical size and shape.

- An adjustable chair that provides firm, comfortable support is best. Adjust the height of the chair so your thighs are horizontal and your feet flat on the floor.

The back of the chair should support your lower back (lumbar region). Follow the manufacturer's instructions for adjusting the backrest to fit your body properly.

- When you use the computer keyboard, your shoulders should be relaxed. Your upper arm and forearm should form an approximate right angle, with your wrist and hand in roughly a straight line.

You may have to raise your chair so your forearms and hands are at the proper angle to the keyboard. If this makes it impossible to rest your feet flat on the floor, you can use a footrest with adjustable height and tilt to make up for any gap between the floor and your feet. Or you may lower the desktop to eliminate the need for a footrest. Another option is to use a desk with a keyboard tray that's lower than the regular work surface.

- Position the mouse at the same height as your keyboard. Allow adequate space to use the mouse comfortably.
- Arrange the monitor so the top of the screen is slightly below your eye level when you're sitting at the keyboard. The best distance from your eyes to the screen is up to you, although most people seem to prefer 18 to 28 inches (45 to 70 cm).
- Position the computer to minimize glare and reflections on the screen from overhead lights and windows.

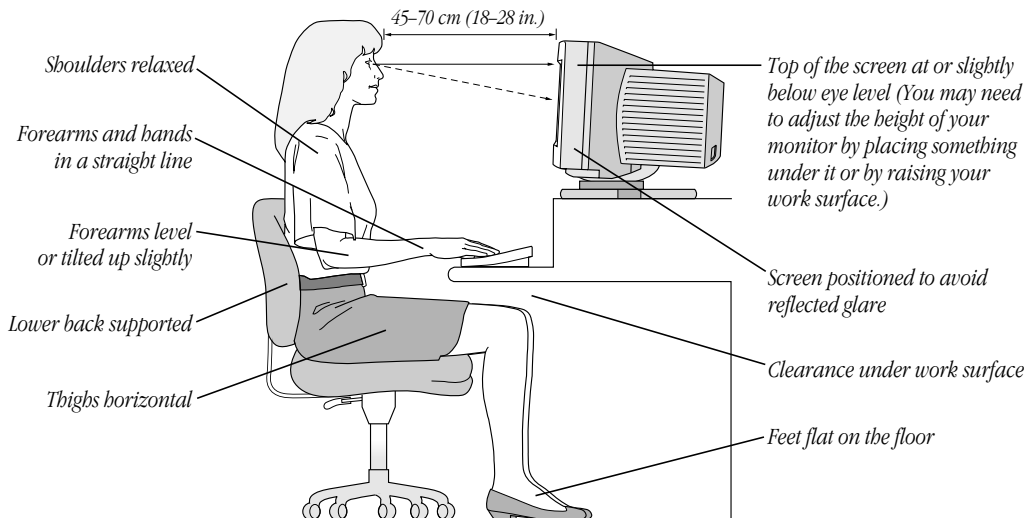

## Avoiding Fatigue

- Change your seated position, stand up, or stretch whenever you start to feel tired. Frequent short breaks are helpful in reducing fatigue.
- Use a light touch when typing or using a mouse and keep your hands and fingers relaxed.
- Some computer users may develop discomfort in their hands, wrists, or arms after periods of intensive work without breaks. If you begin to develop chronic pain or discomfort in your hands, wrists, or arms, consult a qualified health specialist immediately.
- Allow adequate workspace so that you can use your keyboard and mouse comfortably. Place papers or other items so you can view them easily while using your computer. A document stand may make reading papers more comfortable.
- Eye muscles must work harder to focus on nearby objects. Occasionally focus your eyes on a distant object, and blink often while you work.
- Clean your screen regularly. Keeping the screen clean helps reduce unwanted reflections.

## What About Electromagnetic Emissions?

There has been recent public discussion of the possible health effects of prolonged exposure to extremely low frequency (ELF) and very low frequency (VLF) electromagnetic fields. Such fields are associated with electromagnetic sources such as television sets, electrical wiring, and some household appliances—as well as computer monitors.

Apple has reviewed scientific reports and sought the counsel of government regulatory agencies and respected health organizations. Based on the prevailing evidence and opinions, Apple believes that the electric and magnetic fields produced by computer monitors do not pose a health risk.

In response to those customers who wish to reduce their exposure to electromagnetic fields, Apple has lowered the emission levels of our products. We have also promoted further scientific research so we can continue to promote the health and safety of our customers and employees.

## Safety Instructions

For your own safety and that of your equipment, always take the following precautions.

Turn off the computer completely and disconnect the power plug (by pulling the plug, not the cord) if any of the following conditions exist:

- the power cord or plug becomes frayed or otherwise damaged
- you spill something into the case
- your Macintosh is exposed to rain or any other excess moisture

- your Macintosh has been dropped or the case has been otherwise damaged
- you suspect that your Macintosh needs service or repair
- you want to clean the case (use only the recommended procedure described later in this chapter)

Be sure that you always do the following:

- Keep your Macintosh away from sources of liquids, such as wash basins, bathtubs, shower stalls, and so on.
- Protect your Macintosh from dampness or wet weather, such as rain, snow, and so on.
- Read all the installation instructions carefully before you plug your Macintosh into a wall socket.
- Keep these instructions handy for reference by you and others who may use your computer.
- Follow all instructions and warnings dealing with your system.

**Warning** Electrical equipment may be hazardous if misused. Operation of this product, or similar products, must always be supervised by an adult. Do not allow children access to the interior of any electrical product and do not permit them to handle any cables.

## Handling Your Computer Equipment

Follow these guidelines for handling your computer and its components:

- When setting up your computer, place components on a sturdy, flat surface, and carefully follow all setup instructions.
- When connecting or disconnecting a cable, always hold the cable by its connector (the plug, not the cord).
- Turn off your computer and all its components before connecting or disconnecting any cables to add or remove any component. Failure to do so could seriously damage your equipment.
- Never force a connector into a port. If the connector and port do not join with reasonable ease, they probably don't match. Make sure that the connector matches the port and that you have positioned the connector correctly in relation to the port.
- Take care not to spill any food or liquid on the computer, keyboard, mouse, or other components. If you do, turn your computer off immediately and unplug it before cleaning up the spill. Depending on what you spilled and how much of it got into your equipment, you may have to bring your equipment to an Apple-authorized service provider.

- Protect the computer and its components from direct sunlight and rain or other moisture.
- Keep all ventilation openings clear and unobstructed. Without proper air circulation, components can overheat, causing damage or unreliable operation.

**Warning** This equipment is intended to be electrically grounded. Your Macintosh is equipped with a three-wire grounding plug—a plug that has a third (grounding) pin. This plug will fit only a grounded AC outlet. This is a safety feature. If you are unable to insert the plug into the outlet, contact a licensed electrician to replace the outlet with a properly grounded outlet. Do not defeat the purpose of the grounding plug!

### Handling the Monitor

Follow these procedures for handling a monitor:

- Turn down the screen brightness control if you leave the computer turned on for extended periods. If the brightness is not turned down, the image on the screen could “burn in” and damage the screen.

You can also use a “screen saver” program, which dims or varies the image on the screen when the computer has been idle for a specified period of time. These programs are available from independent suppliers and user groups.

- Make sure the vents on the computer are clear and unobstructed.
- If there is interference on the monitor’s screen or on a television or radio near your computer, move the affected equipment farther away.

### Handling the Keyboard

Take care not to spill any liquid on the keyboard. If you do, turn off your computer immediately.

- If you spill liquid that is thin and clear, turn off your computer, unplug the keyboard, turn it upside down to let the liquid drain out, and let it dry for 24 hours at room temperature. If, after you take these steps, the keyboard doesn’t work, take it to your Apple-authorized service provider for repair.
- If you spill liquid that is greasy, sweet, or sticky, unplug the keyboard and take it to your Apple-authorized service provider for repair.

## Handling Floppy Disks

Store disks at temperatures between 50° F and 125° F.

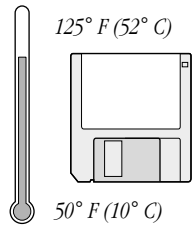

Do not use a pencil or an eraser on a disk or disk label.

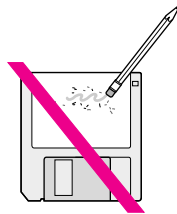

Keep disks dry.

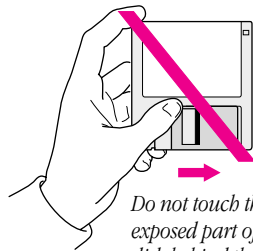

Do not touch the exposed part of the disk behind the metal shutter.

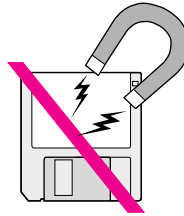

Keep disks away from magnets.

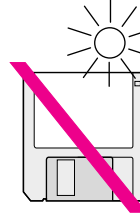

Avoid exposing disks to extremely hot temperatures.

## Handling Zip Disks

Store disks at temperatures between  $-8^{\circ}\text{F}$  and  $122^{\circ}\text{F}$ .

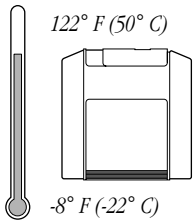

Do not use a pencil or an eraser on a disk or disk label.



Keep disks dry.

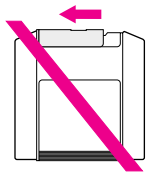
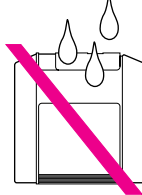

Do not touch the exposed part of the disk behind the metal shutter.

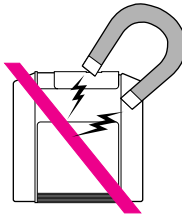

Keep disks away from magnets.

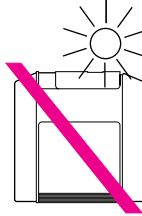

Avoid exposing disks to extremely hot temperatures.

## Handling CD-ROM Discs

Keep these important safety instructions in mind as you use CD-ROM discs:

- Hold a disc by the edges or by one edge and the center hole. Do not touch the disc surface.
- To clean discs, wipe the shiny surface with a soft damp cloth, working in straight lines from center to edge. Do not use any form of cleaning agent.
- To avoid damage to your discs, keep these points in mind:

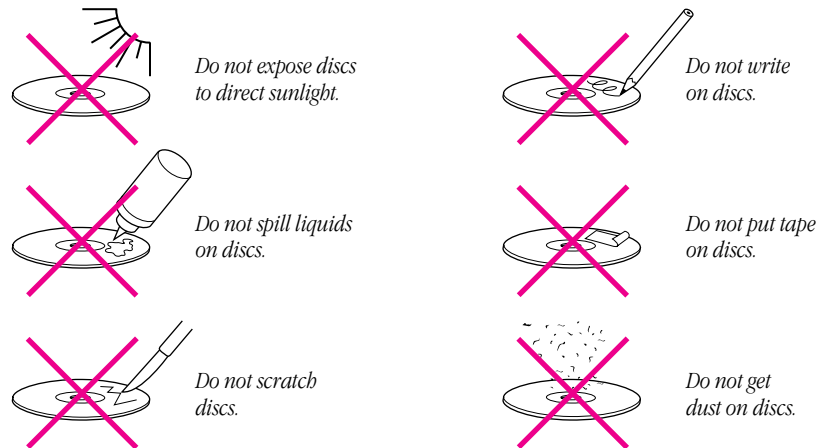

Other important safety instructions to keep in mind as you use your CD-ROM drive:

- Position your computer so that when the tray opens, it doesn't bump into anything.
- Do not leave the disc tray open. If dust gets on the lens of the CD-ROM drive, the drive may have problems reading your compact discs.
- Do not put anything (for instance, a cup) on top of the tray when it is open.
- Do not force the tray open by hand.
- Do not wipe the lens with a paper towel or other abrasive surface. If you need to clean the lens, see an Apple-authorized service provider for a lens cleaner.
- Never transport your computer with a disc inside the CD-ROM drive.
- Keep your computer equipment away from any source of liquid (such as wash basins, bathtubs, and shower stalls). If you drink coffee or other beverages while you're at your computer, take care not to spill.
- Avoid exposing your equipment to damp or wet weather. If your system is near a window, be sure the window is closed in rainy weather.

The tray on your CD-ROM drive automatically closes when you shut down your computer. You may want to open the tray and take out your CD-ROM disc before shutting down.

## Power Supply

The power supply in your computer is a high-voltage component and should not be opened for any reason, even when the computer is off. If the power supply needs service, contact your Apple-authorized dealer or service provider.

**Warning** To protect the power supply from damage, make sure the voltage switch on the back of the computer is set correctly before you plug the computer into a power outlet. See Chapter 1 for instructions on setting the voltage switch.

## Cleaning Your Equipment

Follow these general rules when cleaning the outside of your computer and its components:

- Use a damp, soft, lint-free cloth to clean the computer's exterior. Avoid getting moisture in any openings.
- Don't use aerosol sprays, solvents, or abrasives.

### Cleaning the Computer Case

To clean the case, do the following:

- 1 Turn off the computer completely and then disconnect the power plug. (Pull the plug, not the cord.)
- 2 Wipe the surfaces lightly with a clean, soft cloth dampened with water.

### Cleaning the Monitor

To clean the screen, put household glass cleaner on a soft cloth and wipe the screen.

### Cleaning the Mouse

The mouse contains a small ball that must roll smoothly for the mouse to work properly. You can keep this ball free of dirt and grease by using the mouse on a clean, lint-free surface and cleaning it occasionally.

You need a few cotton swabs and a clean, soft, lint-free cloth.

- 1 Turn off your computer.
- 2 Turn the mouse upside-down and turn the plastic ring on the bottom counterclockwise to disengage it.

See the following illustration.

If the mouse is locked, see the next section, "Locking and Unlocking the Mouse," for instructions on how to unlock it.



- 3 Turn the mouse right-side up with one hand and catch the ring and the ball with your other hand.
- 4 Clean the three small rollers inside the mouse with a cotton swab moistened with water. Rotate the rollers to clean all around them.

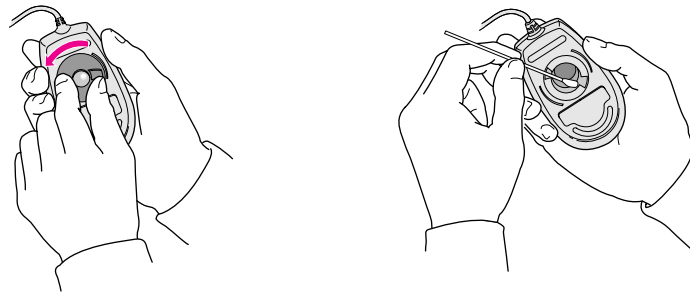

- 5 Wipe the mouse ball with a clean, soft, dry, and lint-free cloth.
- 6 If necessary, wash the mouse ball with warm soapy water (use a mild soap such as a dishwashing liquid) and then dry the mouse ball thoroughly.
- 7 Gently blow into the mouse case to remove any dust that has collected there.
- 8 Put the ball and the ring back in place.

Your mouse should roll smoothly across your mouse pad or desk. If it doesn't, repeat these instructions carefully.

### Locking and Unlocking the Mouse

Some mouse devices can be locked so that the ball can't be removed. A locking mouse has a small hole on the plastic ring.

To lock the mouse, follow these steps:

Insert a straightened paper clip into the hole on the plastic ring and press down on the paper clip while you turn the ring clockwise.

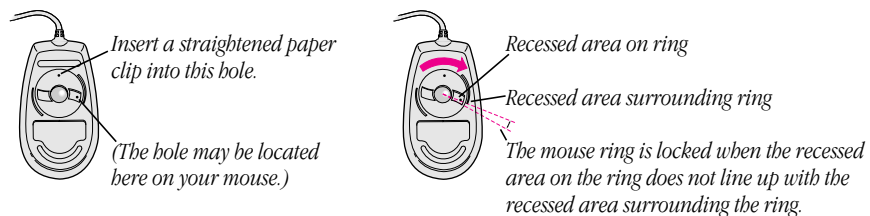

Turn the ring a very short distance, until it stops. When the recessed area on the ring is *not* lined up with the recessed area surrounding the ring, the mouse is locked.

To unlock the mouse, follow these steps:

Insert a straightened paper clip into the hole on the plastic ring and press down on the paper clip while you turn the ring counterclockwise.

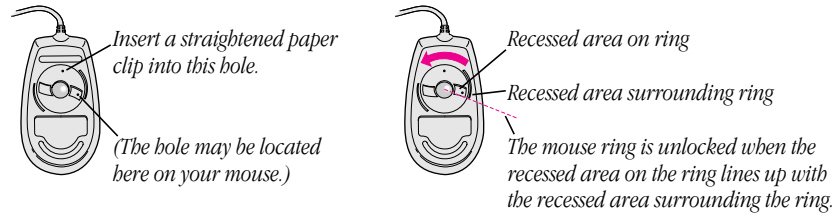

Turn the ring a very short distance. When the recessed area on the ring is lined up with the recessed area surrounding the ring, the mouse is unlocked.



# Setting Up Your Power Macintosh

Includes setup, expansion, and health-related information  
for Power Macintosh G3 minitower computers

 **Apple Computer, Inc.**

© 1998 Apple Computer, Inc. All rights reserved.

Under the copyright laws, this manual may not be copied, in whole or in part, without the written consent of Apple.

The Apple logo is a trademark of Apple Computer, Inc., registered in the U.S. and other countries. Use of the “keyboard” Apple logo (Option-Shift-K) for commercial purposes without the prior written consent of Apple may constitute trademark infringement and unfair competition in violation of federal and state laws.

Every effort has been made to ensure that the information in this manual is accurate. Apple is not responsible for printing or clerical errors.

Apple Computer, Inc.  
1 Infinite Loop  
Cupertino, CA 95014-2084  
408-996-1010  
<http://www.apple.com>

Apple, the Apple logo, AppleTalk, LaserWriter, LocalTalk, Mac, Macintosh, PlainTalk, PowerBook, Power Macintosh, and StyleWriter are trademarks of Apple Computer, Inc., registered in the U.S. and other countries.

Finder is a trademark of Apple Computer, Inc.

NuBus is a trademark of Texas Instruments.

PowerPC and the PowerPC logo are trademarks of International Business Machines Corporation, used under license therefrom.

Other company and product names mentioned herein are trademarks of their respective companies. Mention of third-party products is for informational purposes only and constitutes neither an endorsement nor a recommendation. Apple assumes no responsibility with regard to the performance or use of these products.

Simultaneously published in the United States and Canada.



# Contents

Communications Regulation Information v

Laser Information vi

## **1 Setting Up Your Computer 1**

Positioning and Plugging In the Computer 3

    Voltage Switch Settings for Different Locations 4

Connecting a Monitor 5

Connecting the Mouse and the Keyboard to the Computer 7

Connecting a Modem 9

Turning the Computer On 10

    Problems Turning Your Computer On? 11

What's Next? 12

Turning the Computer Off 12

## **2 Using Your Macintosh and Connecting Additional Equipment 13**

Your Computer's Components and Front Panel Controls 14

Your Computer's Ports and Connectors 16

Using the Computer's Built-in Drives 18

    Using the CD-ROM Drive 18

    Using the Floppy Disk Drive and Optional Zip Drive 19

Connecting Audio Equipment 19

    The Sound Input and Output Ports 19

    The Optional Left and Right RCA-Type Audio Ports 20

    Connecting Most Audio Equipment 21

    Connecting and Using a Microphone 23

Connecting Video Equipment	24
Connecting Video Equipment for Input to the Computer	25
Connecting Video Equipment for Output From the Computer	28
Connecting a Television	30
Connecting External SCSI Devices	32
Before You Connect a SCSI Device	32
Connecting a SCSI Device	34
Connecting a Printer	35
Connecting a Second Monitor	36
Connecting an ADB Input Device	36
Connecting to a Local Area Network	37
Connecting to a LocalTalk Network	38
Connecting to a 10Base-T Ethernet Network	40
Connecting to Multiple Networks Simultaneously	41
Configuring Your Network Connection	41
Securing Your Computer	42

### **3 Installing PCI Cards, Memory, and Internal Storage Devices 43**

About PCI Expansion Cards	43
Expansion Card Power Requirements	44
About Memory	44
DRAM Configurations	45
Video Memory Configurations	45
About Internal Storage Options	45
Connecting an Additional ATA Device	46
Connecting an Internal SCSI Device	47
Installing a PCI Expansion Card, Memory, or an Internal Storage Device	48
Opening the Computer	48
Installing a PCI Expansion Card	53
Installing DRAM or Video Memory	58
Installing a Hard Disk or Other Storage Device	61
Closing the Computer	66
What's Next	69

### **Appendix Health, Safety, and Maintenance Tips 71**

## Communications Regulation Information

### FCC Declaration of Conformity

This device complies with part 15 of the FCC rules. Operation is subject to the following two conditions: (1) This device may not cause harmful interference, and (2) this device must accept any interference received, including interference that may cause undesired operation. See instructions if interference to radio or television reception is suspected.

### Radio and Television Interference

The equipment described in this manual generates, uses, and can radiate radio-frequency energy. If it is not installed and used properly—that is, in strict accordance with Apple’s instructions—it may cause interference with radio and television reception.

This equipment has been tested and found to comply with the limits for a Class B digital device in accordance with the specifications in Part 15 of FCC rules. These specifications are designed to provide reasonable protection against such interference in a residential installation. However, there is no guarantee that interference will not occur in a particular installation.

You can determine whether your computer system is causing interference by turning it off. If the interference stops, it was probably caused by the computer or one of the peripheral devices.

If your computer system does cause interference to radio or television reception, try to correct the interference by using one or more of the following measures:

- Turn the television or radio antenna until the interference stops.
- Move the computer to one side or the other of the television or radio.
- Move the computer farther away from the television or radio.
- Plug the computer into an outlet that is on a different circuit from the television or radio. (That is, make certain the computer and the television or radio are on circuits controlled by different circuit breakers or fuses.)

If necessary, consult an Apple-authorized service provider or Apple. See the service and support information that came with your Apple product. Or, consult an experienced radio/television technician for additional suggestions.

**Important** Changes or modifications to this product not authorized by Apple Computer, Inc., could void the FCC Certification and negate your authority to operate the product.

This product was tested for FCC compliance under conditions that included the use of Apple peripheral devices and Apple shielded cables and connectors between system components. It is important that you use Apple peripheral devices and shielded cables and connectors between system components to reduce the possibility of causing interference to radios, television sets, and other electronic devices. You can obtain Apple peripheral devices and the proper shielded cables and connectors through an Apple-authorized dealer. For non-Apple peripheral devices, contact the manufacturer or dealer for assistance.

*Responsible party:* Robert Steinfeld, Apple Computer, Inc., 1 Infinite Loop, Cupertino, CA 95014-2084, 408-974-2618.

### Industry Canada Statement

This Class B device meets all requirements of the Canadian interference-causing equipment regulations.  
Cet appareil numérique de la Class B respecte toutes les exigences du Règlement sur le matériel brouilleur du Canada.

### VCCI Class 2 Statement

#### 情報処理装置等電波障害自主規制について

この装置は、情報処理装置等電波障害自主規制協議会 (VCCI) の基準に基づく第二種情報技術装置です。この装置は、家庭環境で使用することを目的としていますが、この装置がラジオやテレビジョン受信機に近接して使用されると、受信障害を引き起こすことがあります。

取扱説明書に従って正しい取り扱いをしてください。

### Laser Information

**Warning** Making adjustments or performing procedures other than those specified in your equipment's manual may result in hazardous radiation exposure.

**Warning** Do not attempt to disassemble the cabinet containing the laser. The laser beam used in this product is harmful to the eyes. The use of optical instruments, such as magnifying lenses, with this product increases the potential hazard to your eyes. For your safety, have this equipment serviced only by an Apple-authorized service provider.

Your Power Macintosh computer is a Class 1 laser product. The Class 1 label, located in a user-accessible area, indicates that the computer meets minimum safety requirements. A service warning label is located in a service-accessible area. The labels on your product may differ slightly from the ones shown here.

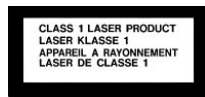

Class 1 label

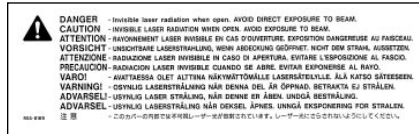

Service warning label

### High-Risk Activities Warning

This computer system is not intended for use in the operation of nuclear facilities, aircraft navigation or communications systems, or air traffic control machines, or for any other uses where the failure of the computer system could lead to death, personal injury or severe environmental damage.